

# INFINIUM<sup>®</sup>



## 2026 Product Catalog

Intuitive, reliable, and effective patient monitors, surgical, critical care and exam equipment.



# CATALOG

## Table of Contents

### Patient Monitoring, Critical Care, Diagnostic, & Exam Equipment

- 3** About Infinium<sup>®</sup> Medical
- 4** Patient Monitors
- 11** Diagnostics & Imaging
- 15** Pain Therapy
- 16** Intubation
- 18** Anesthesia
- 20** Electrosurgical
- 22** Surgical Lights
- 30** Surgical Tables
- 35** Surgical Chairs
- 40** Stretchers
- 41** Warming Devices
- 43** Stainless Cabinets
- 44** Stainless Tables & Stands
- 45** Stainless Sinks
- 46** Refurbished Equipment

Equipment for Patient Monitoring, Operating Room, Critical Care, & Outpatient Procedures



## About Infinium<sup>®</sup> Medical

With over 30 years of innovation, Infinium<sup>®</sup> Medical is an ISO/CE and FDA-registered medical device manufacturer specializing in high-quality patient monitoring, critical care, and operating room equipment. Infinium's vision is to supply reliable, intuitive, and cost-effective medical devices to both the domestic and global markets. Our experienced biomedical engineering team provides after-sales and warranty services to ensure you are fully satisfied and running smoothly.



### Infinium Medical's commitment is guided by the following principles:

#### Products

Anchored by our research procurement programs, Infinium Medical manufactures and services products which are:

- Innovative with leading-edge technology
- Solution-based for optimizing healthcare
- Focused on offering the highest value to our customers
- We are committed to the continued development and introduction of world class products

#### Engineering & Distribution

- Manufacturing, sales, marketing, and distribution for all Infinium<sup>®</sup> equipment
- Management and real-time tracking of complex inventory
- Service and repair of all Infinium<sup>®</sup> Medical products
- Automated shipping, packaging, and receiving
- Product/order tracking and traceability

#### Customer Focus and Support

Ensure our customer's requirements are known and provide all customers with:

- Same-day shipping on most orders
- Unmatched product technical support
- Worldwide distribution of product & service parts
- Best-in-class responsiveness and service
- Committed to continuous improvement and customer satisfaction

#### Facilities

Infinium<sup>®</sup> is located in West Central Florida and operates out of a 15,000 square foot state-of-the-art facility. Our fully automated operations utilize the latest software and technology to ensure quality products with fast and accurate delivery.

The background of the bottom section is a blue-tinted photograph of a medical professional in a white coat and stethoscope, looking at a patient in a hospital bed. The Infinium logo and "SINCE 1991" are overlaid on the left side of this image.

**INFINIUM<sup>®</sup>**  
SINCE 1991

## Contact

Sales: [sale@infiniummedical.com](mailto:sale@infiniummedical.com)  
Service: [service@infiniummedical.com](mailto:service@infiniummedical.com)  
Address: 12151 62nd Street North  
Largo, FL 33773 USA  
Phone: 1-727-531-8434  
Toll Free: 1-866-918-8434  
Web: [infiniummedical.com](http://infiniummedical.com)



# Alpha M Series™

## Modular High Acuity System

The Alpha M Series has been engineered from the ground up to allow practitioners to measure and maintain a continuous stream of patient vital signs data in every setting within the healthcare environment.

**Emergency Room**

**Bedside**

**Pre & Post Operating**

**Intensive Care**

**Operating Room**

Standard ECG, SPO2, TEMP, BP, & respiration

ECG 3, 5, or, 12 lead

Large bright touch screen

Built-in recorder & HL7 output to EMR

ST and arrhythmia detection

Battery backup

Optional wireless central station

Optional EtCO2

Optional anesthesia agent with auto-ID

Optional cardiac output & and invasive BP



**ALPHA M5 Vitals Module**



**Advanced Networking**

**Coming Soon!**

**ALPHA M5**



**ALPHA M5 Carrying Case**



**ALPHA M5 Cradle**



# OMEGA 12™

## Versatile Connected Monitoring

The Omega 12™ is an intuitive, adaptable patient monitor designed for fast-paced healthcare environments. Its high-resolution 12.1" touch screen enables quick adjustments, default settings, and alarm limits while storing up to 72 hours of patient data.

### Comprehensive Parameters

Standard ECG, RESP, NIBP, & TEMP  
Standard Masimo SET Pulse Oximetry

**Optional:** EtCO2 & Anesthetic Agent Analysis, IBP & Cardiac Output

- ✓ Configurable to your workflow & environments
- ✓ Designed to follow the patient
- ✓ Modern field upgradable tech
- ✓ Local patient data always with the patient
- ✓ Network, Wifi, & HL7 data connectivity
- ✓ **Infinium video laryngoscope 12" screen integration**

**Coming Soon!**



All Infinium monitors include a best-in-class 5 year warranty



## OMNI<sup>®</sup> III

### 15" High Acuity Anesthesia Monitor

- ECG, SPO2, TEMP, BP, RESP, FiO2, N2O
- Dräger 5 anesthetic agent measurement with auto-ID
- ECG 3, 5, or, 12 lead
- Built-in recorder & HL7 output to EMR
- ST and arrhythmia detection
- Touch screen
- Battery backup
- Optional central station
- Optional EtCO2
- Optional cardiac output and invasive blood pressure



## OMNI<sup>®</sup> II

### 12.1" Portable Patient Monitor

- Standard ECG, SPO2, TEMP
- Blood pressure, and respiration
- Optional EtCO2
- Optional invasive blood pressure
- Touch screen
- Built-in recorder
- ST and arrhythmia detection
- HL7 output to EMR
- Battery backup
- Central station option

## OMNI<sup>®</sup> EXPRESS

### 7" Transport Patient Monitor

- Standard ECG, SPO2, TEMP, blood pressure, and respiration
- Optional EtCO2
- ECG 3/5 lead
- Touch screen
- Built-in recorder
- ST and arrhythmia detection
- HL7 output to EMR
- Battery backup
- Central station option



Coming Soon!

# CLEO2™



## VITALS & SPOT CHECK MONITOR

Offers a range of tools and adaptable operating modes to suit various clinical needs. Built with transmission capabilities, it allows clinicians to send monitoring data from the bedside, simplifying workflows, increasing operational efficiency, and reducing potential errors.

### Comprehensive Parameters

Available with NIBP, SpO2, Pulse, & TEMP

**Optional:** EtCO2, Infrared Temp, Printer, and Bluetooth Scanner / Keyboard, & Mouse

**TOUCHSCREEN:** 10.1-inch high-resolution, multi-touch capacitive touchscreen display, featuring an intuitive user interface

**OPERATION MODES:** Continuous monitoring or spot check

**SpO<sub>2</sub> TECHNOLOGY:** Options include Nellcor, or Infinium

**NIBP:** Measures with manual, automatic, average, and STAT modes for flexibility in clinical applications

**ETCO<sub>2</sub>:** Optionally available with integrated sidestream EtCO<sub>2</sub> with measurements of EtCO<sub>2</sub>, & awRR with waveform display

**PATIENT SCORING:** Early warning MEWS & NEWS clinical scoring

**PATIENT DATA:** Quickly access up to 120 hrs of trend data

**NETWORKING & INTEROPERABILITY:** Wired or wireless configurations. Bi-directional HL7 communication with HIS/EMR



### Modern Tech & Feature Options

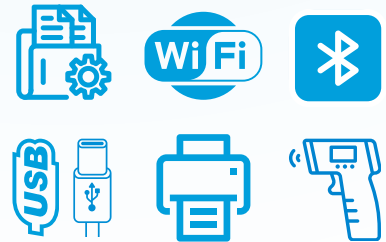

### Includes:

Internal rechargeable lithium batteries; standard configuration includes one battery (up to 4 hours operation), expandable to two batteries for up to 8 hours of operation. Accessory Kit for Adults including SPO<sub>2</sub> Finger Sensor and NIBP Cuff. Power Cord.





## CLEO™ Portable Vitals & Capnography

Reliable, Accurate, & Affordable Per Patient Cost

Blood pressure & SpO2

5" Touch screen

Lightweight with battery backup

Mount on a rolling stand, IV pole, or wall

**Optional Temperature Modules**

**Optional EtCO2 configurations**

The Cleo™ is an intuitive approach to patient vital signs measurement. It can be configured to measure any combination of non-invasive blood pressure and SpO2.

Weighing in at less than **3 LBS** the portable Cleo™ is well suited for any patient care area by offering multiple vital sign combinations. The Cleo™ can be used as a primary pulse oximeter/BP monitor or configured to a NIPB/SpO2.

Cleo™ is well suited for both bedside and mobile spot check use. The monitor simplifies clinician use with a simple touchscreen interface. A long-life lithium-ion battery is standard and many mounting solutions are available.



**Masimo SET® SpO2 technology available and recommended**

Ask about integrated wireless temporal temperature options



### Exclusive NIBP features include:

**Inflation Pressure** – Users can set the initial inflation burst to a setting suitable for their patient base.

**Inflation Memory** – Recalls the patient's most recent Systolic measurement and adjusts the inflation pressure to the most comfortable level.

**Auto Inflation** – Users can set the Auto Inflation from 1-240mins, in 1min increments.

**Historical Data** – Recall the last 300 readings.



**(866) 918-8434**  
infiniummedical.com

# OmniView™ Central Station

## Simplicity In Connectivity

The Omniview™ archives full disclosure of all patient information and vital sign trends. The system displays real-time patients' numeric vital signs along with waveforms. The patient data from the Omniview™ can be transferred to an EMR as a supplement to the patient's file or integrated into a hospital information system.



### Real-Time Vital Signs

Across Your Entire Facility



## Features

- Expandable to manage up to 64 total patient monitors
- Up to 4 widescreen displays. 16 patients per display
- Heart Rate, last BP reading, SpO2, Temp, EtCO2
- Respiration rate with waveforms
- Real-time printing, review printing, case text printing
- 120hr full disclosure review
- Audible/visual alarms with upper and lower limits
- Supports HL7 for HIS, CIS, and other systems
- Bed monitoring window with drug dose calculation

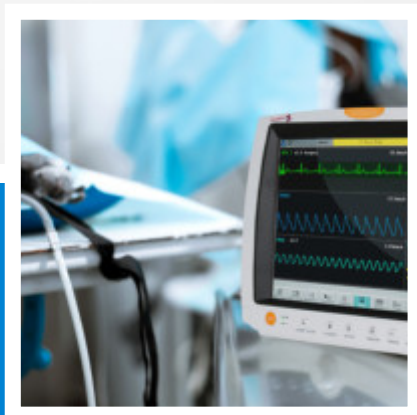

## Omni™ Series Compatibility

The **OmniView™** Central Station is compatible with any combination of Omni™ series monitors. This provides a reliable and flexible way to manage a wide range of vital signs throughout your facility.



MAIN & SIDESTREAM ETCO2 MODULES

## Monitoring Modules Supplies & Accessories

Make a reliable connection with these optional Omni® series accessories.



EKG CABLES & LEADS



EKG ELECTRODES



ECG CABLES & LEADS



ECG TRUNK CABLES



NIBP CUFFS & ADAPTERS

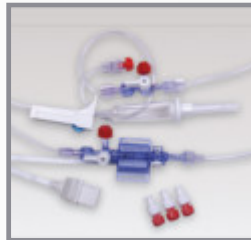

IBP CABLES & PROBES



TEMPERATURE PROBES



ECG TRUNK CABLES



SPO2 SENSORS & CABLES



ETCO2 SAMPLE & CANNULA



ETCO2 MODULES



ETCO2 ADAPTERS



BATTERIES



PRINTER PAPER



MOUNTS



STANDS



3 Second Scan Results

## VioScan™

### Portable Bladder Scanner

**Superior Precision:** Featuring a single motor and 128 sensors, the PBS V 7.1 delivers precise, electronic bladder contour focusing,

**Fast Performance:** With measurements completed in just 3 seconds,

**Enhanced Durability:** The single-motor design reduces friction, increasing the product's longevity and reducing maintenance needs.

**Safety and Reliability:** Equipped with negative pressure technology for much greater reliability.

The Infinium VioScan is engineered to improve accuracy, speed, and reliability, making it an essential tool for modern medical practices.

## QRS-12™ Interpretive ECG

### 12 Lead Touch Screen ECG / EKG

The QRS-12 offers a high-resolution 9-inch touch screen and alphanumeric keypad to optimize the speed of patient care. Providers can make quick and convenient analysis while having multiple print and data transfer options.

Portable with a high-resolution 9-inch touchscreen

Waterproof and full alphanumeric keyboard

Broad frequency response for weak signal & and pediatrics

Specific age and gender differential validity algorithm

ECG module streamlines electrode placement

Up to 300-sec waveforms reviewable and recordable

Up to 300 seconds R-R analysis - arrhythmia locating

Supports key file formats: XML, DICOM, JPG, and PDF





## Stryker Laparoscopy Towers

Recertified Options Designed to Fit Your Budget & Practice

**Refurbished**



Industry leading arthroscopy and rigid scope procedures. Available with tower cart system or stand alone.

### Stryker HD Camera Systems

We service and support 1200, 1400, & 1500 Series.

### Stryker 9000 Series Light Sources

Efficient and long lasting recertified 400W options.

## Professionally Refurbished C-ARMs

### REFURBISHED GE OEC 9800 C-ARM



**Refurbished**

### REFURBISHED INSIGHT FLUOROSCAN FD

#### Enhanced with

##### High Resolution Imaging Option

Option to utilize full detector resolution

##### Low Dose Option

Option to reduce dose rates by over 50% compared to auto mode, while still providing clinically equivalent images

##### Compact

Redesigned Monitor Arm and integrated keyboard



**Refurbished**



## Infinium VioScan L2

### Handheld Linear Ultrasound

- Quick charging 2hr battery life
- Seamless DICOM connectivity integration with EMR
- Fast connection across Windows, iOS, & Android
- Customize 30+ imaging parameters
- 15+ preset medical protocols
- Smart AI Assisted Clinical Support
- IP67 waterproof unit with a feather-light design
- 4.2-12.5 MHz bandwidth with 12.6cm penetration

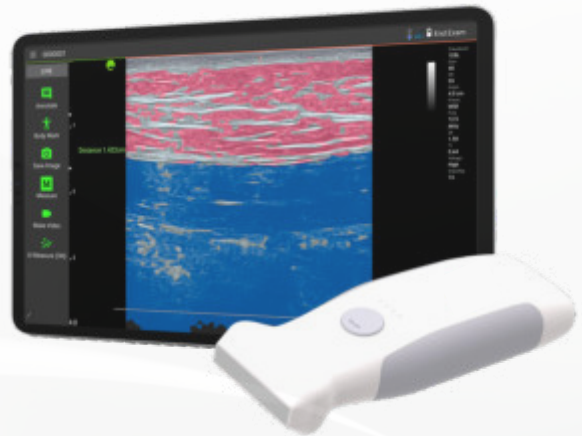

### NO SUBSCRIPTION REQUIRED



## Infinium VioScan C7

### Handheld Convex Ultrasound

A state-of-the-art portable, wireless, convex ultrasound scanning device designed to provide quality imaging in a compact, user-friendly package.

- Quick charging 2hr battery life
- Seamless DICOM connectivity with EMR
- Connections for Windows, iOS, & Android
- Customize 30+ imaging parameters
- 15+ preset medical protocols
- Smart AI Assisted Clinical Support
- Feather-light IP67 waterproof unit
- 2.0-5.0 MHz bandwidth with 11.8in penetration depth



# VS Series Infrared Vein Finder

VS Series Vein Viewers projects near-infrared light with no radiation. The light presents a clear image of the vein pattern.

- Long Battery Life
- Adjustable Depth
- Multiple Color Modes
- Adjustable Brightness
- Alignment Guides
- Data Export & Storage

VS30™



GOOD

VS400™

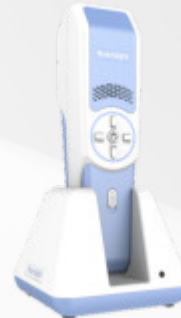

BETTER

VS500™



BEST



ROLLING



DESK MOUNT



TABLE TOP

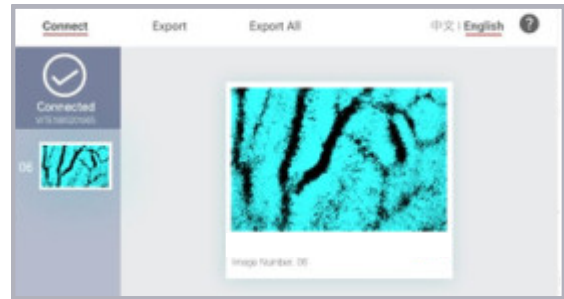

COMPUTER IMAGING SOFTWARE SUITE



Forehead (Child)



Hand



Obesity Patient(hand)



Old patient

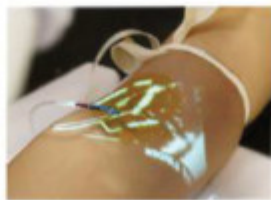

Draw Blood



Dark Skin(hand)



Dark Skin(foot)

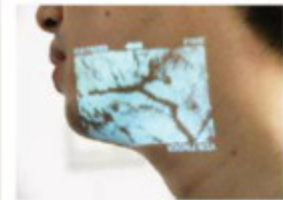

Face

Pediatrics » Oncology » Radiology » Emergency » Geriatrics  
Laboratory » Surgery » Outpatient » Plastic » Vascular

## FOCUS SERIES

### Clinical Grade Shockwave Therapy Systems



The Infinium FOCUS™ is a clinical grade electromagnetic hybrid shockwave therapy system designed to induce intracellular and extracellular reactions to assist in the healing and recovery of soft tissue.

The technology is being used in today's most advanced and effective clinical settings. The therapy better accelerates blood flow to the treated area to induce vasodilation and angiogenesis while restoring and improving musculoskeletal tissue.



#### 25+ PRESET MEDICAL PROTOCOLS

- Chronic Back Pain
- Shoulder Calcific Tendinitis
- Degenerative Joint Ankle
- Patellar Tendinopathy
- Tendonitis of the Wrist
- Tennis Elbow
- Hip Pain
- Tibial Stress Syndrome
- Heel Spurs
- Erectile Dysfunction
- Trigger Points Neck
- Upper Trapezius Strain
- Cervical Spondylosis
- Bicep Tendonitis
- Rotator Cuff
- Golfer's Elbow
- Carpal Tunnel Syndrome
- De Quervain's Tenosynovitis
- Lumbar Spondylosis
- Herniated Nucleus Pulposus
- Paravertebral Syndrome
- Lumbar Mobilization Block
- Piriformis Syndrome
- Hamstring Shortening
- Osteoarthritis of the Knee
- Calf Muscle Strain
- Quadricep Spasm

Ask about our **PORTABLE** clinical grade option.



#### PhysioPro

Easy to use 7" touch-screen controls Includes foot pedal

## Infinium ClearVue® VL3R

### Reusable Video Laryngoscope

#### COMPACT, ERGONOMIC, & INNOVATIVE

- Lightweight - unit is less than 350g
- Quick installation and removal of blade
- Quick shot camera button for recording
- 4 GB data storage (up to 80 hours of video)
- Optional HDMI output to remote display
- 4-inch HD display
- Anti-fog lens
- 2.0 mega pixel camera with video

#### DURABLE

- 2-year warranty
- Screen is reinforced with anti-shatter protection
- Lightweight long-lasting rechargeable battery

#### LOW COST PER PATIENT BLADES

- Reusable blades can be used up to 1000 times
- Comprehensive blade offering comes standard with Macintosh size 2,3, and 4 blades
- Macintosh Blades Size 1,2,3,4,5 Available
- Macintosh Curved "D" Blades Size 1,2,3,4,5 Available
- Miller Blades Size 0,1 available



Comes standard with size 2, 3, and 4 reusable Mac blades.

#### OPTIONAL BLADES



## Infinium ClearVue® VL4D

### Disposable Blade Video Laryngoscopes

- Lightweight - weighs less than 1 lb.
- Quick installation and removal of blade
- Quick shot camera button for recording
- 8 GB data storage (up to 15 hrs video)
- Optional HDMI output to remote display
- Screen is reinforced with anti-shatter protection
- Lightweight long long-lasting rechargeable battery
- Macintosh Blades Sizes 2,3,4 Available

## ClearVue® VLXL Video Laryngoscope

### Operating Room Ready

State-of-the-art image technology with a 2.0-megapixel full-view camera and 8-inch high-resolution monitor. The ClearVue features a rechargeable Li-ion battery for mobile use. The HD optics offer a unique anti-fog and high-resolution image. The overall design is compact and ergonomic. A high-resolution view of the glottis will enable the clinician's first attempt success while minimizing any chance of a complication during the intubation process.

#### FEATURES

- High-resolution 8 Inch Screen
- Rigid steel construction of handpieces
- Quick installation and removal of blades
- Quick shot camera button for photo and video recording
- 4 GB data storage (approx. 80 minutes of stored video)
- Use on battery or AC power
- Optional ergonomic custom rolling stand
- Complete blade offerings
- Reusable blade model

#### COMPREHENSIVE & COST EFFECTIVE RESUABLE BLADES

- Standard with Macintosh Size 2,3, and 4 Blades
- Macintosh Blades Size 1,2,3,4,5 Available
- Macintosh Curved "D" Blades Size 1,2,3,4,5 Available
- Miller Blades Size 0,1 available





## Professionally Refurbished Anesthesia Systems

Infinium Medical® has years of experience with sourcing, engineering, and providing timely service for anesthesia systems from the brands you know and trust. We can help fit your budget with equipment that provides the level of care you and your patients expect.

## Benefits

Match your current fleet with popular options from GE, Dräger, and Mindray

Save 30% to 50% compared with new

Reduce training and onboarding



Ask about Infinium's portable anesthesia & sedation options.



BUY WITH CONFIDENCE  
WE STAND BEHIND THE  
QUALITY OF OUR WORK

## Anesthesia Solutions

### Refurbished Vaporizers

Infinium stocks and has reliable sources for refurbished vaporizers. Ask your representative how we can help maintain your fleet.



### Scavenging



### Intubation



### Agent Analysis





# Infinium OBA-1

## Compact Anesthesia System

- Small operating rooms
- Changing environments & easy storage
- Take it with you



- Small and compact unit for office-based anesthesia
- Lightweight machine weighs only 35 pounds.
- MRI safe with shielded or unshielded magnets.
- Two gas machine (O2 & Air)
- Side handles and self-contained unit for transport
- Conveniently located gas ports
- Many ventilator options are available.
- Optional carrying case with retractable handle and casters
- Optional mobile trolley with shelf
- Auxiliary O2 flowmeter port
- Also available with MRI-compatible Nuffield Ventilator



### MRI Compatible

May be placed within the 5 Gauss line without interfering with scanning.

OBA-1® MRI Unit is used with MRI scanner models from Picker, GE and Siemens



Office Based Anesthesia (OBA) • MRI scan rooms • Dental anesthesia  
Missionary off-shore anesthesia • Remote locations in hospitals outside O.R.  
Disaster scenes and mass casualty incidents • Front-line military hospitals  
Shipboard • Aircraft

# EDGE 400™ For High Volume Operating Rooms

The Infinium EDGE 400 is a high-frequency electrosurgical generator ideal for monopolar and bipolar surgery with a wide range of high-precision applications. The system is engineered to execute minimally invasive surgical procedures with resection, evaporation, and coagulation.



## Vessel Sealing Standard

Advanced surgeon and patient safety features  
 (2) Independent monopolar & bipolar output  
 Forced, soft, and spray coagulation  
 Eeschar-free incision, bleed control & slow blend  
 Bipolar vessel sealing up to 7mm  
 10 working memory settings  
 Monopolar activation with handle and/or pedal  
 Digital power regulation and output indicator



# EDGE 200™ For Surgery Centers

The Infinium EDGE 200 is a high-frequency electrosurgical generator ideal for monopolar and bipolar surgery center procedures. The system is engineered to execute minimally invasive surgical procedures with resection, evaporation, and coagulation.

Patient-to-plate contact control  
 Split return electrode use  
 Minimally invasive surgical treatments  
 Independent monopolar and bipolar output  
 Auto start/stop in bipolar coag  
 10 working memory settings  
 Monopolar activation with handle and/or pedal  
 Digital power regulation and output indicator  
 Sound level controls



**200 & 400 Series** are compatible with most popular brand disposable grounding pads and hand switch pencils.



## Infinium EDGE 160™



This 160W generator is ideal for minor surgery procedures for the following specializations: Plastic, Dermatology, Vascular, Dental, Urology, Gynecology, First Aid, and ENT.

**Surgery Functions:** Pure cutting (CUT), cutting-coagulation (BLEND), superficial coagulation (FORCED COAG), deep coagulation without carbonization (SOFT COAG), and bipolar coagulation via a special adapter (optional).

**Continuous Safety Monitoring:** Patient plate connection is constantly monitored. If a dual-field neutral electrode is used, contact between the plate and the patient is also.

**Function Switching:** Switch between various functions and activate power via the handle for flexibility to perform surgery without taking attention away from the work area.

## Infinium EDGE R80™



EDGE R80 is a radiofrequency surgical generator designed for small monopolar surgery with both cut and coagulation. **It is ideal for minor oral, dental, aesthetic, and dermatology use.**

**Surgical Precision:** Designed for small monopolar surgeries

**Versatile Functionality:** Cutting (CUT), cutting and coagulation (BLEND), coagulation (COAG), and micro-coagulation (MICRO)

**Total Control:** Equipped with a micro-control card and digital display for safety and reliable effectiveness.

**Professional Performance:** Ergonomic design and advanced safety systems.

## Refurbished

## Force Triad & FX

Recertified Options for Simple to Complex Procedures

Infinium offers a full lineup of refurbished electrocautery generators from Medtronic / Covidien. These proven generators offer the power and types of procedure options you see day to day in world class veterinary facilities.

**Medtronic Valleylab FT10**

**Covidien Valleylab Force Triad**

**Covidien Valleylab Force FX Series**

**Valleylab Carts & Accessories**



**Valleylab**  
Medtronic COVIDIEN



# LUXOR | L400

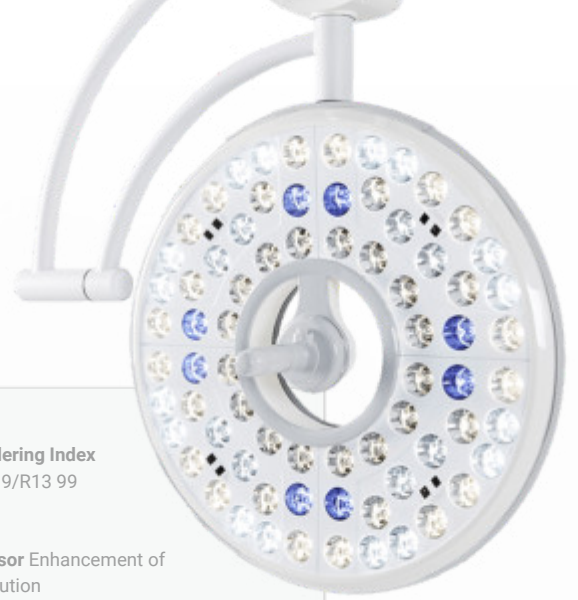

	<p><b>Illumination Intensity</b> Continuous adjustment <b>(Max. 160,000lx)</b></p>		<p><b>Color Rendering Index</b> Ra 99/R9 99/R13 99</p>
	<p><b>Light Field Diameter</b> 7.09 to 13.39 in</p>		<p><b>Smart Sensor</b> Enhancement of shadow dilution &amp; depth of illumination</p>
	<p><b>Color Temperature</b> 3,600K-5,400K</p>		<p><b>ENDO Mode</b> Suitable for endo-surgery by one click, Ec*5%</p>
	<p><b>Synchronized Control</b> One controller can control the other at the same time</p>		

## Continuously Adjustable Light Intensity, Color Temperature and Light Field Diameter

Light intensity (Maximum 160,000lx)  
Color temperature (3,600K-5,400K)  
Light field diameter (7.09 to 13.39 in)

## Smart Sensor in Surgical Lights

Detects movements by the surgeon or medical staff, allowing them to adjust the light's intensity

## Synchronized Control

A synchronization system provides convenience and efficiency by allowing two lights to be controlled simultaneously

## Camera Ready

2026 L400 models come camera ready, so when you are ready it is a seamless addition.

## Optional Features

### 4K Ultra-HD Video Camera

Optional video camera.

### Remote Controls

Convenient & sterile tablet or wall control.



NEW

**4K ULTRA HD**

Optional 4K Video

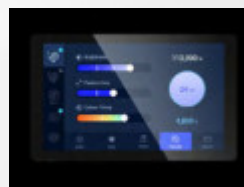

Optional Tablet PC Controller



Optional Wall Controller



# LUXOR | M400

	<p><b>Illumination Intensity</b> Continuous adjustment <b>(Max. 140,000lx)</b></p>		<p><b>Color Rendering Index</b> Ra 99/R9 99/R13 99</p>
	<p><b>Light Field Diameter</b> 7.09 in to 11.81 in</p>		<p><b>Smart Sensor</b> Enhancement of shadow dilution &amp; depth of illumination</p>
	<p><b>Color Temperature</b> 3,600K-5,400K</p>		<p><b>ENDO Mode</b> Suitable for endo-surgery by one click, Ec*5%</p>
			<p><b>Synchronized Control</b> One controller can control the other at the same time</p>

## Continuously Adjustable Light Intensity, Color Temperature and Light Field Diameter

Light intensity (Maximum 140,000lx) Color temperature (3,600K-5,400K) Light field diameter (7.09 in to 11.81 in)

## Smart Sensor in Surgical Lights

Detects movements by the surgeon or medical staff, allowing them to adjust the light's intensity

## Synchronized Control

A synchronization system provides convenience and efficiency by allowing two lights to be controlled simultaneously

## Optional Features



Tablet PC Controller



Wall Controller





# LUXOR | 400 Configurations

Mobile . Single Ceiling . Dual Ceiling . Triple Ceiling

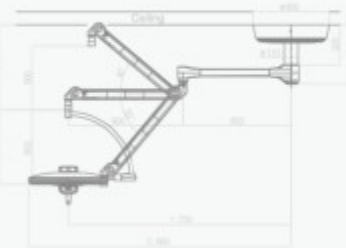
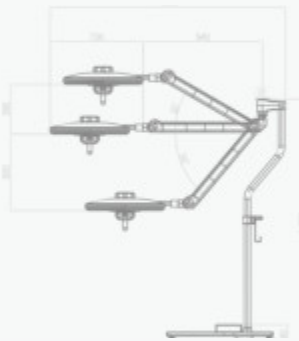
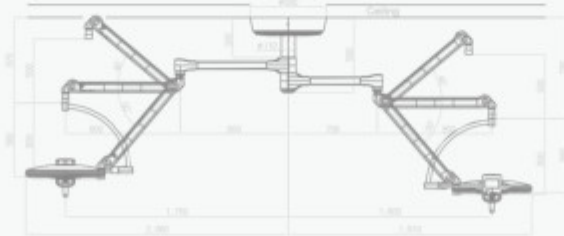
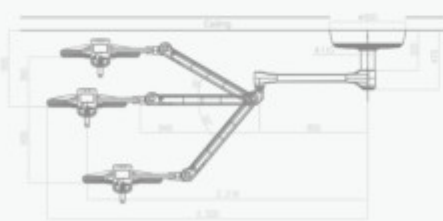

Single Arm  
Only Light

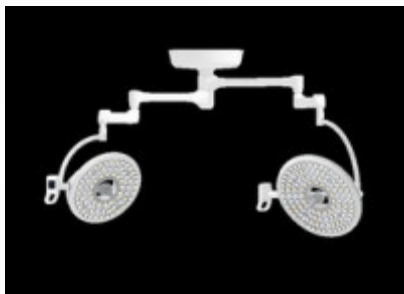

Dual Arm Light  
+ Light  
or  
Light + Monitor



Tri Arm Light + Light +  
Light  
or  
Light + Light + Monitor

## LUXOR | S300

**VERSATILE    MODERN    PERFORMANCE**



**Illumination Intensity**  
3 Step adjustment (Max. 130,000lx)



**Light Field Diameter**  
3 Step adjustment (5.91 to 9.84in)



**Color Temperature**  
3,800K/4,300K/4,800K



**Color Rendering Index**  
Ra 96/R9 95



**3 Different Modes**  
Surgical mode (130,000lx)  
Examine mode (60,000lx)  
Dental mode (30,000lx)

**ARM Touch Control (5" LCD)**

**Light (1 or 2) Control** - Light 1/Light 2 select -  
Light ON/OFF - Light field diameter, Intensity,  
Color temperature  
**Sync Mode** - Light (1 and 2) sync



**Synchronized Control**

A synchronization system provides convenience and efficiency by allowing two lights to be controlled simultaneously

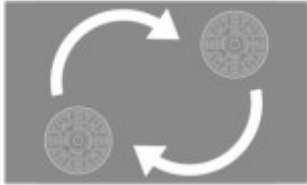

**Handle Touch Control (Quick & Easy)**

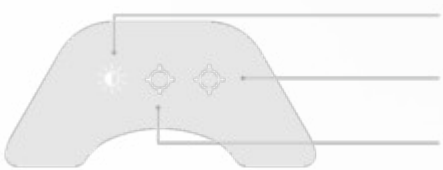

Intensity Control (1 → 2 → 3 → 1, Rotate)  
Light Field Decrease  
Light Field Increase

**Optional Features**



Tablet PC Controller



Remote Controller

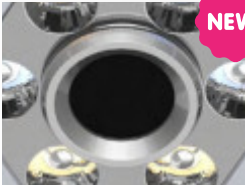

Full-HD Camera



# LUXOR | S300 Camera



**Illumination Intensity**  
3 Step adjustment (Max. 130,000 lx)



**Light Field Size**  
3 Step adjustment (5.91 to 9.84 in)



**Color Temperature**  
3,800K / 4,300K / 4,800K



**Color Rendering Index**  
Ra 96 / R9 95



**Examination Mode**  
3 Step adjustment (Max. 60,000 lx)  
Color Temp. (3,800K / 4,300K / 4,800K)

## Handle Touch Control (Quick & Easy)

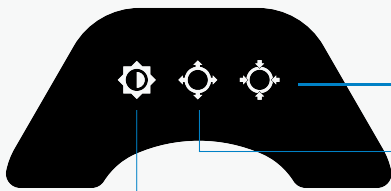

Light Field

Decrease

Intensity Control(1 → 2 → 3 → 1, Rotate)

## Full-HD Camera

Classification	Specification
Image Sensor	1/2.8-type CMOS
Image Point	Approx. 2.14 Megapixels
Lens	Optical
Focus, Aperture	Auto, Manual
Video Signal	HD-SDI(BNC)
Resolution	Full HD 1080p, 1080i, 720p, 720i

**NEW!**





## LUXOR | S300 Configurations

Mobile . Wall . Single Ceiling . Dual Ceiling

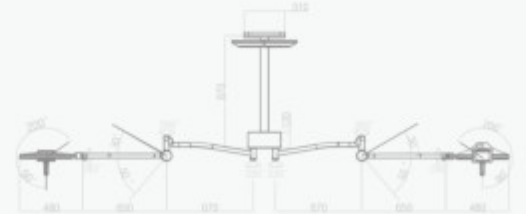
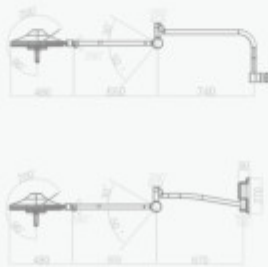

## LUXOR | S250



**Illumination Intensity** 3 Step adjustment (Max. 110,000lx)



**Light Field Diameter** 3 Step adjustment (5.91 to 9.84in)



**Color Temperature** 3,800K/4,300K/4,800K



**Color Rendering Index** Ra 97/R9 97



**ENDO Mode** 3 Step adjustment (5,000lx-15,000lx)

### Handle Touch Control (Quick & Easy)

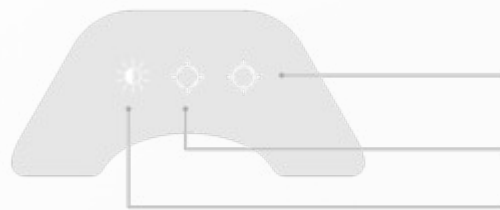

Light Field Decrease

Light Field Increase

Intensity Control (1 → 2 → 3 → 1, Rotate)

### ARM Touch Control

**Light Control** -  
3 step - Brightness (Intensity)  
3 step - Light field diameter  
3 step - Color temperature

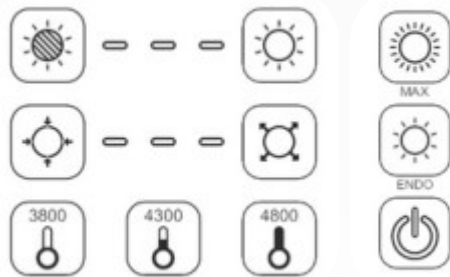

**Max. Mode** - Light field diameter 3 level - Intensity 3 level

**Endo Mode**  
- Light field diameter 1 level  
- Intensity & Color temperature 3 step (5,000lx-15,000lx)

Light ON/OFF

### Optional Features



Remote Controller





New and Smart Design



High Energy Efficiency



Easily Adjustment

## LUXOR | S250 Configurations

Mobile . Wall . Single Ceiling . Dual Ceiling

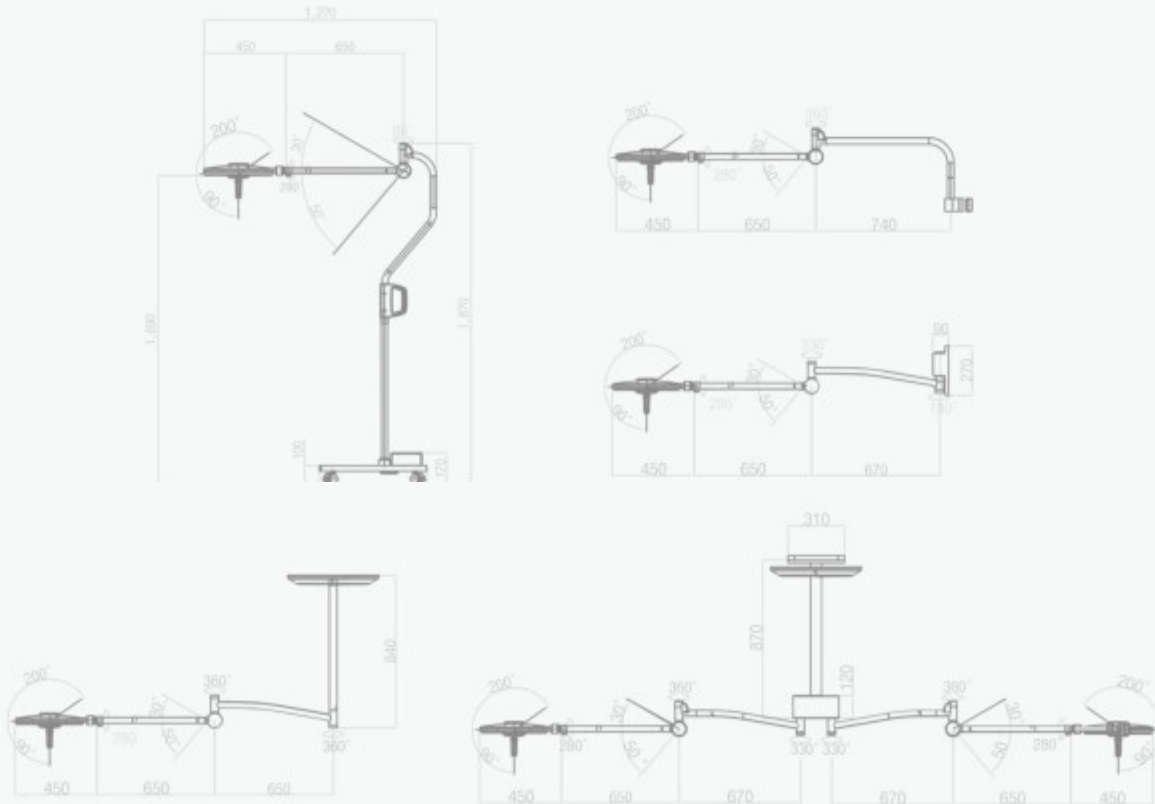

Today's flexible surgical environments require tables that can easily adapt to a variety of situations to bring nurses, technicians, and specialists together to provide better surgeries.



**Smart Alarms**  
(Lock/Unlock/Limit/Anti-Collision)



**Imaging Friendly Features**  
(18" Slide / Radiotranslucent Top)



**LCD Remote Controller**  
(Display Realtime Information)



**360° 4 Swivel Castors**



**Pre-Programmed Memory Position**



**1000 Pound Weight Capacity**



## ST-500 Series



## ST-500 Series Surgical Table

Advanced Engineering & Technology

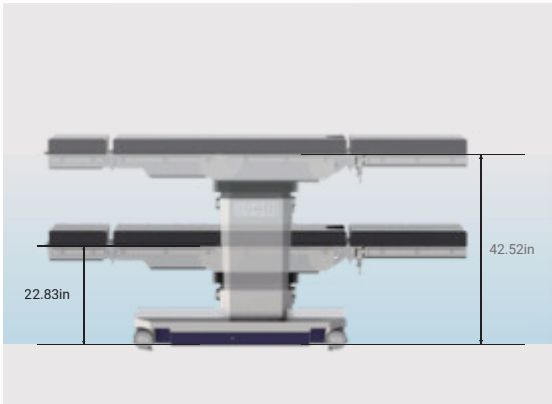
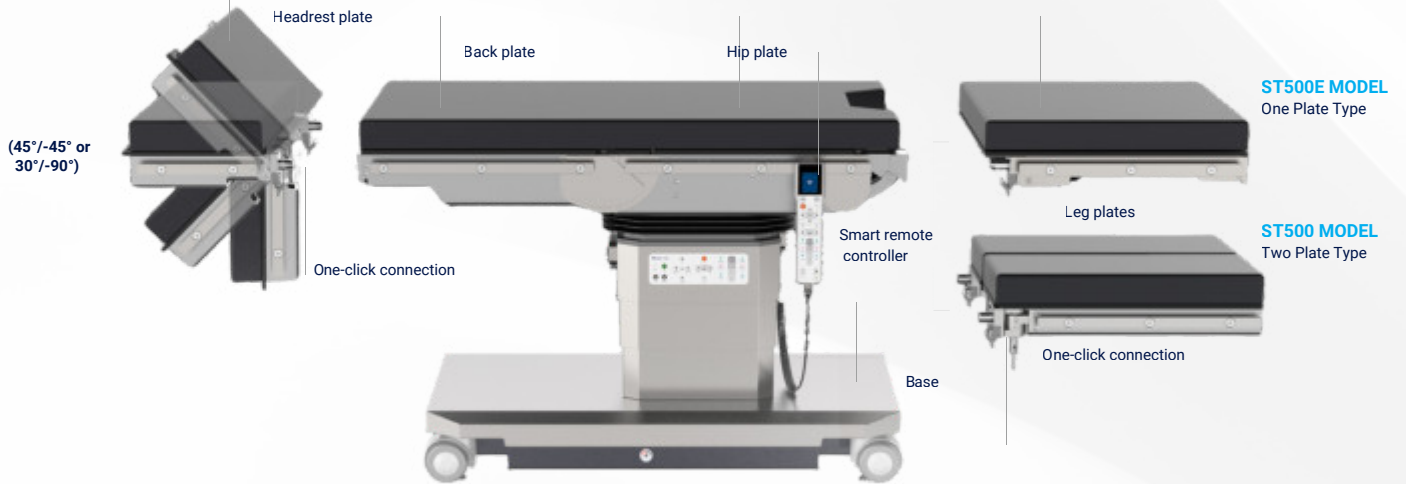

### Versatile

INFINIUM ST500E Surgical table provides an exceptionally low height for MIS,robotic and bariatric techniques without sacrificing the height needed for orthopedic and cardiac procedures



### Efficient

Optimal solution for cardiovascular surgery with wide imaging access and better radiolucency



### Intelligent

Intelligent remote control makes it easy to precisely adjust the patient's position

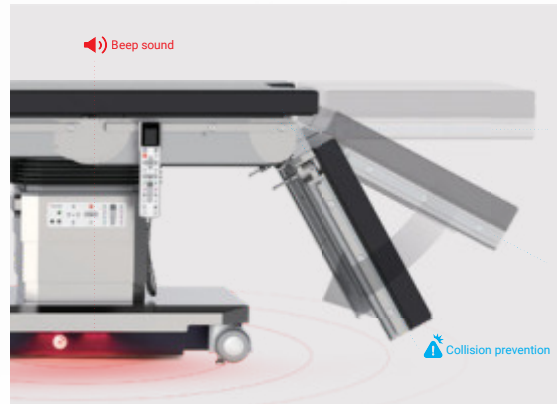

### Safe

revolutionary surgical table that allows for safe and secure surgeries

## ST-300 Series Surgical Table



### FULLY FEATURED & BUDGET FRIENDLY



#### Value

The ST300 is engineered as a cost effective alternative to the Luvis ST500 series. It rock solid and includes most of the popular features while being affordable for even small to medium sized surgery centers.



#### Efficient

Wide imaging access ensures efficient for high-quality image acquisition



#### Intelligent

Intelligent remote control makes it easy to precisely adjust the patient's position

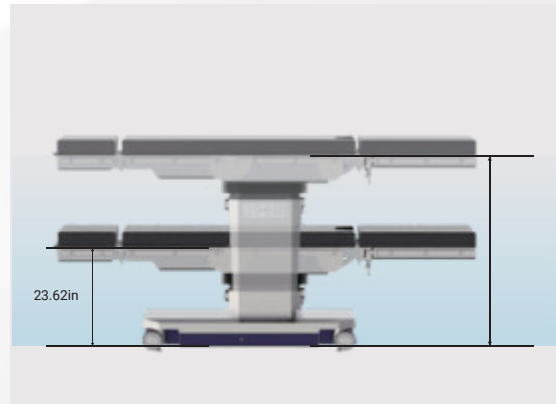

#### Versatile

INFINIUM ST300 Surgical table provides an exceptionally low height for MIS, robotic and bariatric techniques without sacrificing height for orthopedic and cardiac procedures

## Technical Specifications

### Construction features

The ST300 is designed as a more affordable and slightly more compact version of the ST500 while maintaining most of the key features

Can operate with internal power and external power

4 point self leveling floor locks ensure stable positioning of the table with fully mechanical emergency brake release

Column casing and base cover made of stainless steel

Supporting frames for the seat section and back section made of aluminum leg plate sockets, joint covers and side rails made of stainless steel

Operating table top subdivided into four sections : headrest, back plate, seat plate, leg plates

Symmetrical accessory interfaces for Normal and Reverse positioning

If the electronics or hydraulics fail, an integrated tool can manually unlock the brakes

### Electrical data

Specially designed batteries with capacity for two working days use in the operating room

Electronic monitoring of the battery charge level with optical indicator

Batteries recharged from mains power supply, 50-60 Hz, via power supply cord

### Rail Dimensions:

9.5mm x 28.5mm  
.375" in x 1.125" in

	LUVIS ST500E	LUVIS ST300
Length of Surgical Tabletop (in)	2,173	2,123
Width Without Side Rails (mm)	20.47	20.47
Width Across Side Rails (in)	22.52	22.52
Weight (lbs)	705	617
Maximum Overall Load <small>*patient and accessories</small>	<ul style="list-style-type: none"> <li>• 1,000lb (454kg) patient support, including raise/lower (when centered on the column in normal orientation)</li> <li>• 600lb (272kg) full table articulation, including slide</li> <li>• 350lb (159kg) : reverse mode</li> </ul>	
Height Without Padding (in)	22.8-42.5	23.6-39.4
Trendelenburg / Reverse Trendelenburg (°)	35/35	35/35
Lateral Tilt (°)	20/-20	25/-25
Back Section (°)	90/-40	90/-40
Leg Section (°)	0/-105 (1plate)	10/-90 (2plates) *manual
Headrest (°) <small>*manual</small>	45/-45 30/-90	45/-45 30/-90
Longitudinal Slide (in)	18.11	11.81
Kidney Elevator (in) OPTIONAL	4.33	4.33
Flex / Reflex (°)	140/90	140/90
Base Brake Mechanism <small>*lock / unlock</small>	Electronic	Electronic





## Universal Table Accessories

FRAMES . EXTENSIONS . PADS . BOARDS . STRAPS . SUPPORTS . CLAMPS . MORE

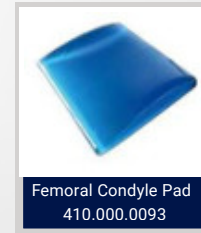
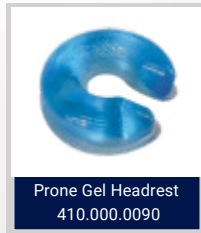
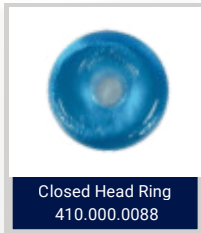
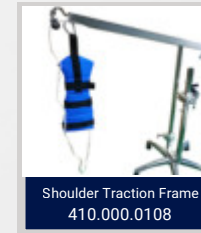
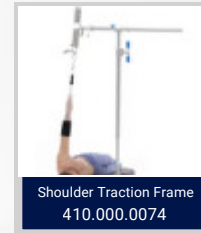
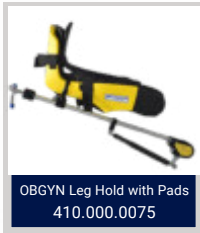
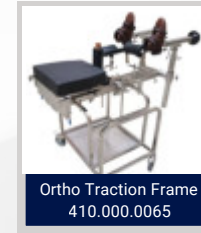
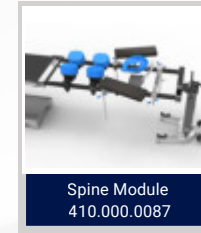
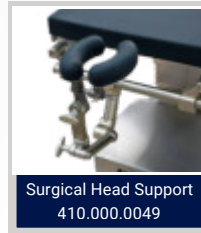
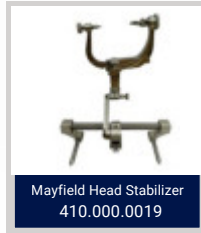
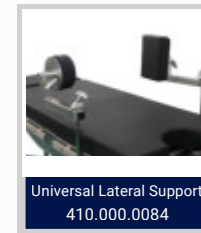
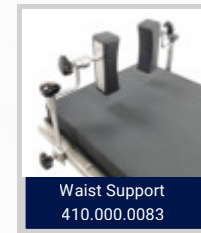
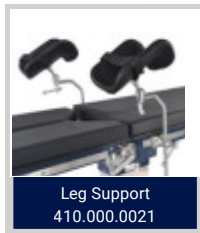
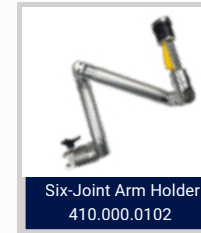
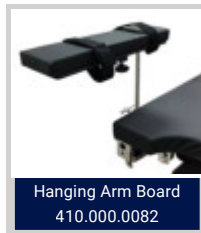
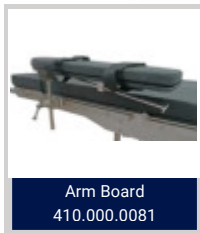
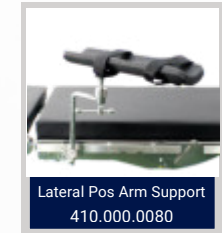
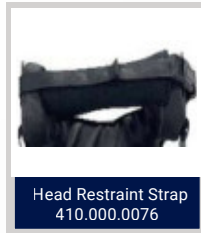

## HS360 Surgical Stool

### Unmatched in Ergonomics Function & Efficiency



Infinium’s HS360 surgical stool is an exceptionally versatile and reliable seating solution, perfectly suited for a wide range of surgical procedures. Its innovative design incorporates numerous features and benefits to enhance user comfort and efficiency. Equipped with intuitive hydraulic foot pedals for effortless height adjustments, along with easily adjustable backrest and armrests, this SurgiStool ensures optimal ergonomics and seamless operation during demanding tasks.

- Adjustable contoured backrest for personalized support
- Dual-density foam seat cushion for enhanced comfort
- Foot-controlled hydraulic system with Y-type base and four smooth-rolling casters for easy mobility
- Front-end locking system for secure positioning
- 360° rotating armrest pads with 180° armrest support for flexible adjustments



High Position	28 in ±1 in (71 cm ±2 cm)
Low Position	21 in ±1 in (53 cm ±2 cm)
Weight Capacity	300 lbs (136 kg)

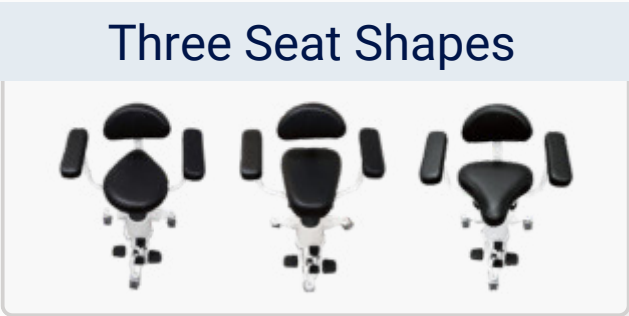

**LemiMD** Monza Move  
**Compact & Mobile Platform**

- Tapered mid-section
- Removable articulating headrest
- Easy-lock smooth casters
- Hand & foot controls
- Accessory side-rails
- Quiet power height, back, leg rest, & trend
- 21.6" barrier-free low height access



Load Capacity: 441 lbs



**Integrated Wheels**

High quality front and rear casters with easy to use breaking system.

Chair Height: 21.6" to 33.8"  
 Mattress Width: 23.2"  
 Mattress Length: 61.8" to 73.2"  
 Chair Weight: 183 lbs

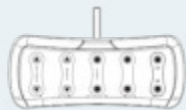

**4M** 4 ELECTRIC MOTORS



M1 - MEMORY FUNCTION



AUT AUTO FUNCTION



Easy-to-clean anatomic mattress without stitching

Electric Trendelenburg

15°



Electric height

55-86 cm  
(21,6"-33,8")



75°

Electric backrest



90° leg inclination  
 Electric legrest



90°



THICKNESS  
 12cm | 4.7"

**LemiMD** Dreamed  
ITALIAN MEDICAL EQUIPMENT

## Power Procedure Chair

### Form Meets Function

- Tapered surgery access
- Adjustable head rest
- Premium easy-to-clean fire resistant medical fabric
- Built-in arm rests
- Quiet power height, back, leg rest, & trend functions
- 20" barrier-free low height
- Hand and foot controls

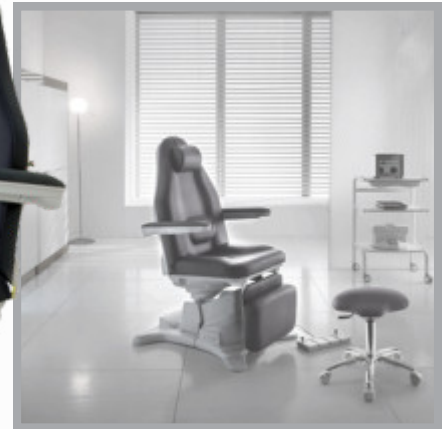
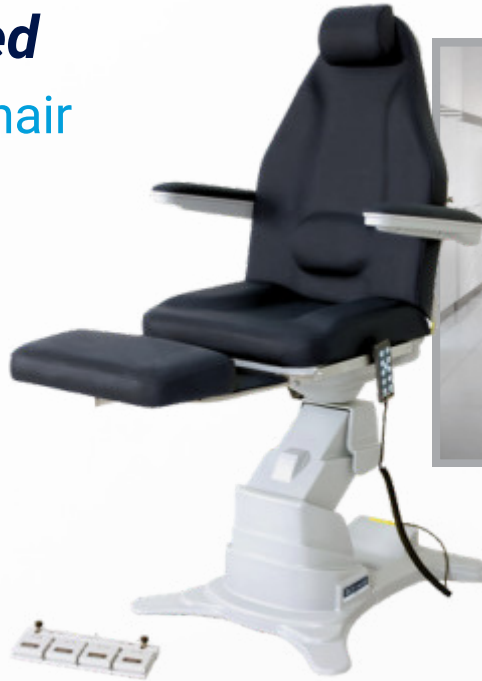

Tapered Headrest Access

Chair Height: 21" to 33"

Mattress Width: 22.8"

Mattress Length: 61.6" to 72.8"

Chair Weight: 166 lbs

Load Capacity: 441 lbs

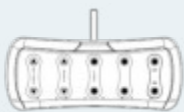

**4M**

4 ELECTRIC MOTORS



**M1 - MEMORY FUNCTION**



**AUT** AUT FUNCTION

75°

Electric backrest



15

Electric Trendelenburg



Electric height

57-87 cm  
(22,4"-34,2")



THICKNESS  
9cm | 3.5"

90° rotation on both sides



180°

Electric legrest

90°



# Power Procedure Table

*Affordable Luxury & Performance*

- Flexible removable headrest options
- Hand and foot controls included
- Accessory base rails
- Premium easy-to-clean fire and bacteria resistant medical fabric
- Smooth power height, back, leg rest, & trend adjustments
- Automatic return to chair function



Load Capacity:  
440lbs

Chair Height: 24.8" to 35.6"

Mattress Width: 24.4"

Mattress Length: 74.8" to 90.6"

Chair Weight: 172 lbs

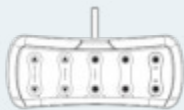

4 ELECTRIC MOTORS



M1 - MEMORY FUNCTION



AUT FUNCTION



SYNCHRO FUNCTION



THICKNESS  
12cm | 4.7"



Electric height

63-90 cm  
(24,8"-35,6")



Removable  
headrest options



Electric backrest

70°

Electric legrest



65°



Synchronized backrest /  
legrest with hand control

## LemiMD Teserra Aesthetic Chair

- Adjustable & interchangeable head & foot sections
- Auto return to original position
- Easy-lock smooth casters
- Hand & foot controls with memory function
- Quiet power height, back, leg rest, & trend
- Extra thick memory foam mattress

Chair Height: 24.8" to 37"

Mattress Width: 24.4"

Mattress Length: 74.8" to 90.5"

Chair Weight: 168 lbs

Load Capacity: 441 lbs



Memory Bi-Zak  
Mattress Option

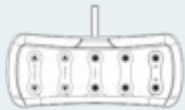

4 ELECTRIC MOTORS



M1 - MEMORY FUNCTION



AUT FUNCTION

**Important:** Specify and verify pad type and color at the time of order.

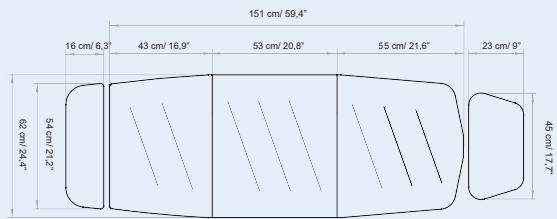

FLAT BI-ZAK



THICKNESS  
SPRESSURE  
6cm | 2,4"

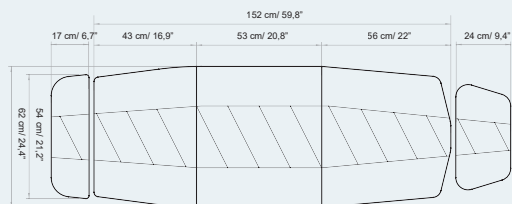

ANATOMIC BI-ZAK



THICKNESS  
SPRESSURE  
12cm | 4,7"

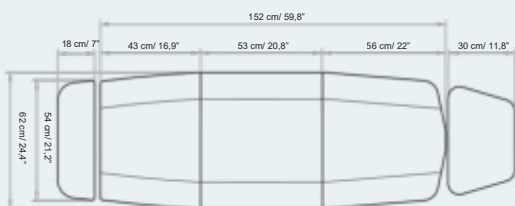

MEMORY BI-ZAK



THICKNESS  
SPRESSURE  
15cm | 5,9"

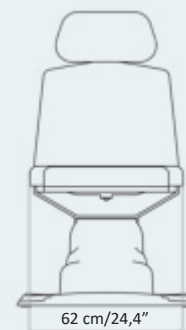
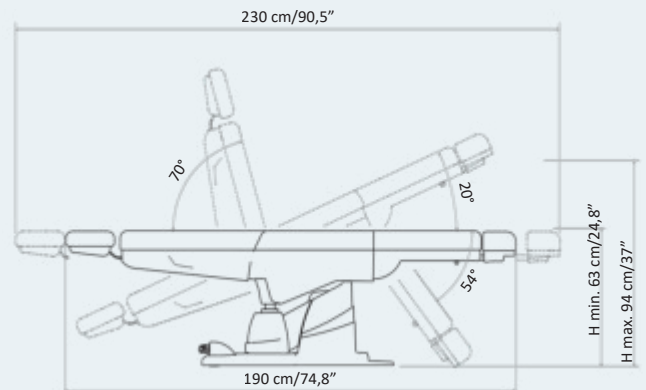

## TRAVERSE *Advanced* Patient Transport Stretcher

The Traverse hydraulic stretcher is designed for the efficient transport of patients in medical facilities, with height adjustable by pedals on both sides. This platform can carry patients weighing up to 550 pounds.

- Steel frame with powder coating finish
- X-ray translucent plastic bed board (optional cassette tray)
- Stainless steel fold-down side rails
- Central braking system with retractable fifth wheel
- Polyurethane coated comfort pad
- Oxygen cylinder holder
- IV pole supports (1 pole included)
- Protective rubber bumpers and push handles
- 2-year warranty



### **5 positioning functions with dual-side pedal controls:**

*Height adjustment (whole bed up/down)*

*Backrest adjustment (pneumatic lever)*

*Leg/knee adjustment (manual crank)*

*Trendelenburg / Reverse Trendelenburg*



# Patient Warming System

## Advanced Forced Air Warming

A lightweight compact forced air warmer that is easy to use and delivers accurate and consistent temperature for a variety of clinical needs.



### Unique Design

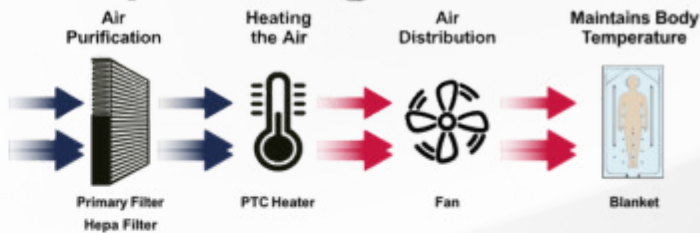

Safe Heating Modules

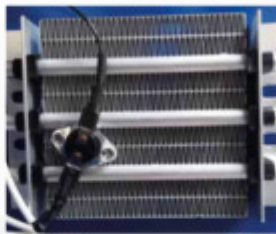

Safe Probes

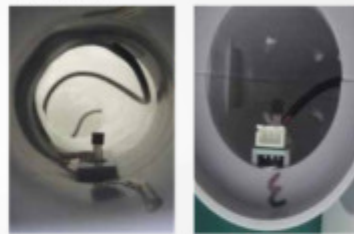

# Blanket & Fluid Warmers

## Single, Dual, and Triple Chamber Options

Warming systems that are highly reliable and come standard with advanced features.

Heights between 24" & 75"

Glass or stainless doors

Up to 3 adjustable shelves

Optional temp & door lock

Temp from 90-160 F

Rapid warming time

Audible & visual temp alarms

Insulated for uniform temp



**SINGLE CHAMBER**  
21 CUBIC FT



**SINGLE CHAMBER**  
9 CUBIC FT



**5 CUBIC FT**



**3 CUBIC FT**



**DUAL CHAMBER**  
17 CUBIC FT



STAINLESS OR GLASS DOORS



## Stainless Operating Room Cabinets 2 Glass Doors & 4 Adjustable Shelves

These stainless cabinets are constructed of 16 gauge type 304 stainless steel. Comes with 4 ea. multiple height adjustable shelves. Tempered glass doors with locking paddle lock handles.

**Standard Unit Size: 47"W x 24"D x 72"H**

Our operating cabinets are available with a free-standing base or with optional heavy-duty locking casters. Custom sizes are available based on your specifications

## All Stainless Built-In Cabinets Custom Configurations & Sizes

Made from heavy-duty 16 gauge 304 stainless steel, our cabinets can be found in many of the industry's leading hospitals and clinics.

Primary options include glass doors, adjustable shelving, lockable doors and drawers, custom sinks, and plumbing fixtures. We can work with your specifications to design a solution to fit your needs.



### Stainless Exam Cabinet with Marine Edge Top

**Medium:** 44" x 22" x 36"  
3 drawers / 1 door with left or right side configurations

**Large:** 58" x 22" x 36"  
3 drawers / 1 door with left or right side configurations



### Stainless Crash & Anesthesia Supply Carts

**Crash Cart:** 28"L x 18"D x 37"H  
4 drawers / open bottom with cable management holes

**Anesthesia Cart:** (Shown)  
28"L x 18"D x 37"H  
3 drawers / 2 bottom doors





Bumpers



MRI SAFE  
OPTIONS

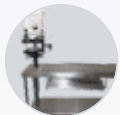

Anesthesia  
Machine Option



### Transport Gurney

Medium: 41"L x 24"D x 36"H  
Large: 60"L x 24"D x 36"H



### Drawer Option

Medium: 46"L x 26"D x 36"H  
Large: 60"L x 26"D x 36"H



★★★★★  
MOST POPULAR

Height Adjustable  
40"W x 23"D  
Marine Edge & Guard



Height Adjustable  
40"W x 23"D



20"L x 16"D x 34"H  
Optional Drawer  
Optional Rail Tray



Height Adjustable  
Mayo 30"W x 26"D  
Marine Edge



Custom Sizes  
Available for All  
Tables & Stands

Heavy-Duty  
16 Gauge  
Stainless Steel



Medium: 41"L x 30"D x 36"H  
Large: 60"L x 30"D x 36"H



48"L x 30"D x 36"H



(866) 918-8434  
infiniummedical.com

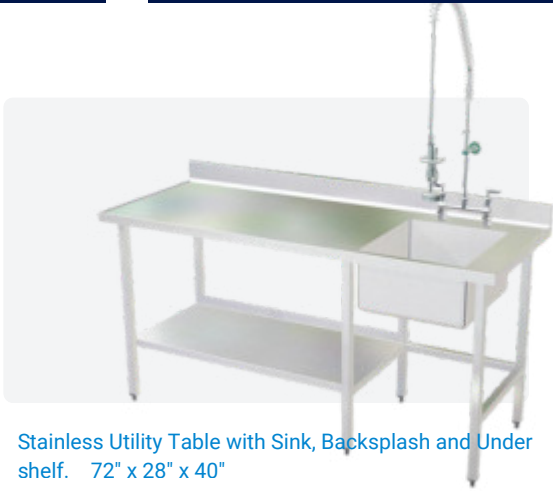

Stainless Utility Table with Sink, Backsplash and Under shelf. 72" x 28" x 40"

## Work & Utility Sinks

Infinium offers professional-grade work sinks designed to meet the most demanding healthcare environments. All of our sinks are fabricated with 16-gauge heavy-duty 304 stainless steel and smooth finished edges and welds. These products are very easy to clean and will last a lifetime.

**All sinks can come in left of right dominate configurations and are available with a variety of plumbing fixture options.**



Stainless Utility/Rinse Sink with 24" Drainboard  
46.25"L x 30"D x 43"H

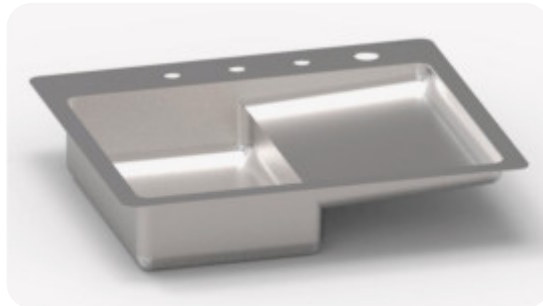

Stainless Drop In Fecal Sink - 22.9" x 22.6" x 11.25"

## Premium Surgical Scrub Sinks



**Single Surgical Scrub Sink with Rounded Corners & 12" Backsplash**

Bowl: 28"L x 18"D x 10.5"H  
Wall Mount: 30"L x 21"D x 22.5"H



**PROFESSIONAL  
BACKSPASH**

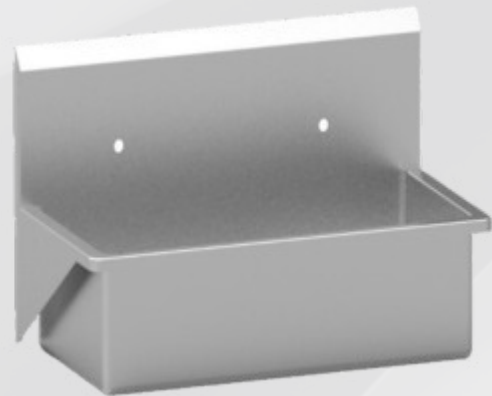

**Double Surgical Scrub Sink with Rounded Corners & 12" Backsplash**

Bowl: 46"L x 18"D x 10.5"H  
Wall Mount: 48"L x 21"D x 22.5"H

Properly maintained refurbished equipment can be a great value for your facility. We have in-house biomedical staff, contracts, and great relationships with the industry's most popular manufacturers and aftermarket service teams.



Specialty Monitors



Defibrillators



Electrosurgical

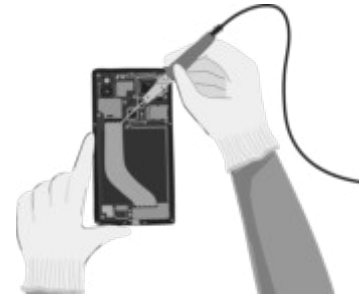

Endoscopy



CT, MRI, & Ultrasound



Respiratory



## Featured Refurbished Products



**Valleylab Force Triad**

Refurbished ForceTriad™ energy platform provides electrosurgical cutting and coagulation, bipolar functionality, and vessel sealing in a single generator.

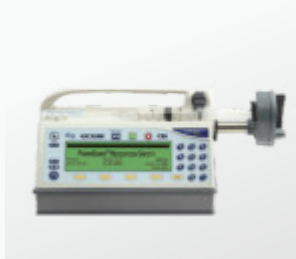

**Medfusion 3500**

Refurbished syringe pump is ideal for precise arterial, epidural, enteral, intravenous, spinal and subcutaneous medication delivery.



**Puritan Bennet 840**

Refurbished ventilator can meet the needs of many patient types. The system features PAV+ software, & supports more natural breathing .



**Philips Invivo Series**

Refurbished Expression MR400 & Precess 3160 MRI compatible monitors for advance features anywhere.



**FITS YOUR  
BUDGET**

**(866) 918-8434**

**Operating Room  
Packages** *from*  
**INFINIUM**®

## **Full Equipment Suites**

We manufacture and source full suites of equipment for your facility and operating room environment. Let our experts craft a package that fits your budget & requirements.



**Infinium Medical, Inc.**

12151 62nd St N #5  
Largo FL 33773 • USA

**Phone: (866) 918-8434**

**Fax: 727-531-8436**

**Web: [infiniummedical.com](http://infiniummedical.com)**

**Email: [sale@infiniummedical.com](mailto:sale@infiniummedical.com)**

