



OMNI II
Patient Monitor

USER'S MANUAL

Infinium Medical Inc.

Website: www.infiniummedical.com

Address: 12151 62nd St North #5 Largo Fl, 33773 USA

Toll Free (US call only): 866-918-8434

International: 1-727-531-8434

Fax: 1-727-531-8436

To obtain information about a warranty, if any, for this product, contact Infinium Medical Inc, Technical Services or your local Infinium Medical, Inc. representative.

PHASEIN is a trademark of PHASEIN AB



RESPIRONICS is a trademark of PHILIPS RESPIRONICS



Masimo is a trademark of Masimo SET



Nellcor is a trademark of NELLCOR OXIMAX



CONTENTS

SAFETY INFORMATION	1
INTRODUCTION	4
INTENDED USE	4
ABOUT THIS MANUAL	4
CONTROLS, INDICATORS, AND SYMBOLS	5
FRONT PANEL	5
LEFT SIDE PANEL	6
RIGHT SIDE PANEL	7
REAR PANEL	7
SYMBOLS	7
DISPLAY SCREEN PARTITION	10
WAVEFORM AREA	11
PARAMETER AREA	11
MESSAGE AREA	11
SYSTEM SETUP	12
FACTORY SEVICING SETUP	12
OPTIONAL MODULE	13
WAVEFORM SELECT	13
PRINTER	13
CONFIG MANAGER	14
DRUG CALCULATION	14
HEMODYNAMIC CAL	14
LANGUAGE SETUP	14
DEMO DISPLAY	15
OTHER SETUP	15
HOW TO MONITOR	16
DISPLAY MODE	17
OXYCRG SCREEN	17
LARGE FONT SCREEN	17
ALARM & SOUND	19
ALARM	19
ALARM SETUP	19
VISUAL ALARM INDICATORS	19
ALARM SUSPEND	20
ALARM SWITCH	20
SOUND	21
ALARM SOUND	21
HEART-BEAT (PULSE-TONE)	21
KEY BEEPS	21
SILENCE	21

ECG MONITORING.....	22
ELECTRODE INSTALLATION.....	22
CABLE AND LEADWIRE INSTALLATION.....	25
ECG SETUP.....	25
ST-SEGMENT ANALYSIS.....	27
ARRHYTHMIA ANALYSIS.....	29
12-LEAD ECG MONITORING.....	30
ERROR MESSAGES OF ECG MONITORING.....	31
MAINTENANCE AND CLEANING.....	31
RESP MONITORING.....	33
RESP ELECTRODE INSTALLATION.....	33
RESP SETUP.....	33
MAINTENANCE AND CLEANING.....	34
SPO2 MONITORING.....	35
SPO2 MONITORING PRINCIPLE.....	35
SPO2 SENSOR INSTALLATION.....	35
SPO2 SETUP.....	35
MEASUREMENT LIMITATIONS.....	37
SPO2 ERROR MESSAGES.....	37
MASIMO INFORMATION.....	38
NELLCOR INFORMATION.....	40
MAINTENANCE AND CLEANING.....	40
NIBP MONITORING.....	41
NIBP MONITORING PRINCIPLE.....	41
NIBP CUFF FITTING.....	41
NIBP MONITORING INITIALIZATION.....	42
NIBP SETUP.....	42
NIBP LIST OBSERVATION.....	46
MEASUREMENT LIMITATIONS.....	46
NIBP ERROR MESSAGES.....	47
MAINTAINENCE AND CLEANING.....	47
TEMP MONITORING.....	48
THEORY OF OPERATION.....	48
TEMP SENSOR INSTALLATION.....	48
TEMP SETUP.....	48
TEMP ERROR MESSAGES.....	49
MAINTAINENCE AND CLEANING.....	49
ETCO2 MONITORING (OPTIONAL).....	50
THEORY OF OPERATION.....	50
WARNINGS.....	50

ABBREVIATIONS AND TERMINOLOGY	51
ZEROING THE CO2 MODULE.....	51
PATIENT AND TUBING PREPARATION	51
ETCO2 SETUP	53
ADVANCED SETUP.....	55
CALIBRATION	56
STATUS/ERROR MESSAGES	56
MAINTENANCE AND CLEANING.....	57
IBP MONITORING (OPTIONAL)	58
THEORY OF OPERATION.....	58
INTRODUCTION	58
WARNING.....	58
PREPARATION FOR MONITORING.....	59
INSTRUCTIONS FOR USE OF TRANSDUCER MONITORING KIT	59
IBP SETUP	60
SET TRANSDUCER ZERO.....	63
PROMPT MESSAGE	64
MAINTAINENCE AND CLEANING.....	64
ANESTHETIC AGENT MONITORING (OPTIONAL, PHASEIN).....	65
PHASEIN IRMA™ MAINSTREAM PROBE.....	65
INTRODUCTION	65
SAFETY	66
SYSTEM ASSEMBLY INSTRUCTION	66
ZEROING PROCEDURE	68
ALARMS.....	69
CLEANING	70
MAINTENANCE	70
PHASEIN ISA™ SIDESTREAM ANALYZER.....	71
INTRODUCTION	71
SAFETY	72
ANALYZER SYSTEM SET-UP.....	73
PRE-USE CHECK.....	73
CONSUMABLE	74
ALARMS.....	76
AUTOMATIC ZEROING.....	77
CLEANING	77
MAINTENANCE	77
MAC (Minimum Alveolar Concentration) CACULATION	78
ADVERSE EFFECTS ON PERFORMANCE	80

ANESTHETIC AGENT DISPLAY	80
ANESTHETIC AGENT SETUP.....	81
ANESTHETIC AGENT MONITORING (OPTIONAL, DRÄGER)	83
THEORY OF OPERATION AND DESCRIPTION	83
PATIENT CONNECTIONS.....	84
ANESTHETIC AGENT DISPLAY	85
ANESTHETIC AGENT SETUP.....	86
MAC (Minimum Alveolar Concentration) Calculation	88
CALIBRATION	89
PATIENT INFORMATION ADMINISTRATION.....	90
PATIENT BASIC INFORMATION SETUP.....	90
ADD NEW PATIENT	91
DELETE PATIENT.....	91
TREND	92
TREND OBSERVATION	92
TIME SETUP.....	92
MARK EVENT SETUP	93
TRENDING INTERVAL	94
TREND GRAPH ANALYSIS.....	94
TABULAR TREND ANALYSIS.....	94
ALARM EVENT	95
LAST WAVEFORM	96
CALCULATION.....	97
INTRODUCTION	97
DRUG CALCULATION	97
HEMODYNAMIC CALCULATION	98
RECALL DATA.....	100
RECALL DATA STORAGE.....	100
RECALL DATA DISPLAY.....	100
RECALL OPERATION DESCRIPTION	100
RS-232 INTERFACE.....	102
OVERVIEW.....	102
CABLE CONNECTION.....	102
EXPORTING TREND DATA.....	102
PRINTER (OPTIONAL)	103
PRINTER SETUP.....	103
PRINT REAL-TIME WAVEFORM.....	103
PRINT TABULAR TREND.....	103
GRID OUTPUT	104
PRINT ALARM EVENT	104

PRINT EVENT LIST.....	104
PRINT EXPLANTION.....	104
WAVEFORM PRINT EXPLANATION.....	105
BATTERY OPERATION.....	106
INTRODUCTION.....	106
CONDITIONING A BATTERY.....	106
BATTERY RECYCLE.....	107
DISPOSAL OF DEVICE COMPONENTS.....	108
PERIODIC SAFETY CHECKS.....	109
CLEANING.....	109
SPECIFICATIONS.....	110
EMC.....	120
NOTE:.....	120
ELECTROMAGNETIC IMMUNITY.....	120

FIGURES

Figure 1: Front Panel.....	5
Figure 2: Left Side Panel.....	6
Figure 3: Right Side Panel	7
Figure 4: Rear View for Main Unit	7
Figure 5: Display Screen.....	10
Figure 6: Tree Diagram for System Setup Menu	12
Figure 7: Keypad to input ASCIIIS	14
Figure 8: Window for oxyCRG.....	17
Figure 9: Window for Large Font	18
Figure 10: 5-lead Electrode Placement	22
Figure 11: C-electrode Placement.....	23
Figure 12: 12-Lead Electrode Placement.....	24
Figure 13: Tree Diagram for ECG Setup	25
Figure 14: Window for ARR Review.....	29
Figure 15: Window for ARR Retail Information.....	30
Figure 16: Window for Full 12-Lead ECG	31
Figure 17: Tree Diagram for Resp Menu	34
Figure 18: Tree Diagram for SpO ₂ Setup Menu.....	36
Figure 19: Tree Diagram for NIBP Setup Menu	42
Figure 20: Window for NIBP List Observation	46
Figure 21: Sketch Map for Replacing the Bladder.....	47
Figure 22: Tree Diagram for Temp Setup Menu	48
Figure 23: Tree Diagram for EtCO ₂ Setup Menu.....	53
Figure 24: Tree Diagram for EtCO ₂ Advanced Setup	55
Figure 25: Tree Diagram for IBP1 or IBP2 Setup Menu	61
Figure 26: Window for IBP1 or IBP2 Wave Scale.....	62
Figure 27: Window for IBP1 or IBP2 Alarm Setup	62
Figure 28: Tree Diagram for Multi-Gas Setup Menu.....	81
Figure 29: Tree Diagram for Multi-Gas Waveform Setup Menu	87
Figure 30: Tree Diagram for Patient Setup	90
Figure 31: Tree Diagram for Time Setup	92
Figure 32: Window for Mark Event Setup.....	93
Figure 33: Window for Event List.....	93
Figure 34: Window for Trend Graph.....	94
Figure 35: Window for Basic Parameters Tabular Trend	95
Figure 36: Window for IBP Tabular Trend.....	95
Figure 37: Window for Alarm Event Review.....	95
Figure 38: Window for Last Waveform Review	96
Figure 39: Window for Drug Calculation	97
Figure 40: Window for Hemodynamic Calculation	98
Figure 41: Window for Indication Information.....	100
Figure 42: Window for Recall Patient.....	101
Figure 43: Window for Trend Management with ID.....	101
Figure 44: Real-time Waveform Print	103
Figure 45: Basic Tabular Trend Print	103
Figure 46: Alarm Event Print	104
Figure 47: Event List Print.....	104

SAFETY INFORMATION

This section contains important safety information relating to general use of the OMNI II Patient Monitor. Other important safety information appears throughout the manual in sections that relate specifically to the precautionary information. Read all text surrounding all precautionary information.

The OMNI II can be powered by one internal battery that provides 2 hours of monitoring from fully charged battery. The batteries are continuously recharged when AC power is connected to the monitor.

A warning message appears on the screen and an audible alarm sounds when the remaining battery power is only enough for 15 minutes of operation. The user should connect the monitor to an external power source to avoid loss of patient monitoring action. External power sources may be connected, disconnected, and reconnected without interrupting the monitoring action.

[NOTE]: Before use, please read this manual carefully.

[WARNING]: OMNI II Patient Monitor should not be used as an apnea monitor.

[WARNING]: The OMNI II is defibrillator proof. It may remain attached to the patient during defibrillation or while an electrosurgical unit is in use, but the readings may be inaccurate during use and shortly thereafter.

[WARNING]: The OMNI II Patient Monitor is a prescription device and is to be operated by qualified personnel only.

[WARNING]: Explosion hazard. DO NOT use the OMNI II in the presence of flammable anesthetics or other flammable substance in combination with air, oxygen-enriched environments, or nitrous oxide.

[WARNING]: Occasionally, electrical signals at the heart do not produce a peripheral pulse. If a patient's beat-to-beat pulse amplitude varies significantly (for example, pulses alternant, atrial fibrillation, rapid-cycling artificial ventilator), blood pressure and pulse rate readings can be erratic and an alternate measuring method should be used for confirmation.

[WARNING]: DO NOT lift the monitor by the sensor cable, blood pressure hose, or power cord because the cable, lead, or cord could disconnect from the monitor, causing the monitor to drop on the patient.

[WARNING]: The OMNI II may not operate effectively on patients who are experiencing convulsions or tremors.

[WARNING]: Disconnect the OMNI II and sensors during magnetic resonance imaging (MRI) scanning. Use during MRI could cause burns or adversely affect the MRI image or the monitor's accuracy. Also, to avoid burns, remove the sensors from the patient before conducting MRI.

[WARNING]: To ensure that the leakage current protection remains within the specifications, use only the patient cables supplied with or specifically intended for use with the OMNI II Monitors. Carefully route patient cables to reduce the possibility of patient entanglement or strangulation.

[WARNING]: The user must check the equipment prior to use and ensure its safe and proper use.

[WARNING]: To ensure patient safety, DO NOT place the monitor in any position that might cause it to fall on the patient.

[WARNING]: For pacemaker patients, the OMNI II may continue to count pacemaker rate during occurrences of cardiac arrest or some arrhythmias. To reduce the likelihood of this, ensure that the Pacer Detect setting is ON in the ECG menu when monitoring such patients. DO NOT rely entirely upon the OMNI II alarms. Keep pacemaker patients under close surveillance.

[WARNING]: Enclosure leakage current is less than 100 microamperes (μA); however, always consider additional leakage current that can be caused by other equipment used on the patient at the same time as these monitors.

[WARNING]: Connection of non-isolated devices to the RS-232 connector may cause chassis leakage to exceed the specification standards.

[WARNING]: DO NOT autoclave, ethylene oxide sterilize, or immerse these monitors in liquid. Use the cleaning solution sparingly. Excessive solution can flow into the monitor and cause damage to internal components. Do not use petroleum-based or acetone solutions, or other harsh solvents, to clean the monitor. These substances attack the monitor's materials and device failure can result. Unplug the monitors before cleaning or disinfecting.

[WARNING]: Do not touch, press, or rub the display panels with abrasive cleaning compounds, instruments, brushes, rough surface materials, or bring them into contact with anything that could scratch the panel.

[WARNING]: DO NOT use the OMNI II to monitor patients who are linked to heart/lung machines.

[WARNING]: To prevent electrical hazards to all personnel, these monitors must be properly grounded. The chassis grounding assembly, Universal Switching Power Supply, and the power cord supplied with the equipment provide this protection. DO NOT attempt to undo this protection by modifying the cords or using ungrounded adapters. DO NOT remove the monitor cover except to replace the battery.

[WARNING]: Connect the monitor only to a three-wire, grounded, hospital-grade receptacle. The three-conductor plug must be inserted into a properly wired three-wire receptacle; if a three-wire receptacle is not available, a qualified electrician must install one in accordance with the governing electrical code.

[WARNING]: If there is any doubt about the integrity of the protective earth conductor arrangement, operate the monitor on internal battery power until the AC power supply protective conductor is fully functional.

[WARNING]: It is possible for the patient to receive a burn due to an improperly connected electrosurgical unit. Additionally, the monitor could be damaged or measurement errors could occur. Certain steps can be taken to mitigate against this problem, such as not using small ECG electrodes, selecting ECG electrode sites remote from the expected RF paths, using large electrosurgical return electrodes, and verifying that the electrosurgical return electrode is properly attached to the patient.

[WARNING]: ECG cables may be damaged if they are connected to a patient during defibrillation. Cables that have been connected to a patient during defibrillation should be checked for functionality before using again.

[WARNING]: Line isolation monitor transients may resemble actual cardiac waveforms and thus inhibit heart rate alarms. Such transients may be minimized by proper electrode and cable placement, as specified in this manual and electrode directions for use.

[WARNING]:

Defibrillation and Electrosurgery: DO NOT touch the patient, or table, or instruments, during defibrillation.

After defibrillation, the screen display recovers within 10 seconds if the correct electrodes are used and applied in accordance with the manufacturer's instructions.

ECG cables can be damaged when connected to a patient during defibrillation. Check cables for functionality before using them again.

According to AAMI specifications the peak of the synchronized defibrillator discharge should be delivered within 60 ms of the peak of the R wave. The signal at the ECG output on the OMNI II patient monitors is delayed by a maximum of 30 ms. Your biomedical engineer should verify that your ECG/Defibrillator combination does not exceed the recommended maximum delay of 60 ms.

When using electrosurgical (ES) equipment, never place ECG electrodes near to the grounding plate of the ES device, as this can cause a lot of interference on the ECG signal.

[Caution]: When connecting the OMNI II to any instrument, verify proper operation before clinical use. Both the OMNI II and the instrument connected to it must be connected to a grounded outlet. Accessory equipment connected to this Patient Monitor must be certified according to the respective IEC standards (e.g. IEC 60950 for information technology equipment and IEC 60601-1 for medical electrical equipment). Furthermore all configurations shall comply with the valid version of the system standard IEC 60601-1-1.

Any person who connects additional equipment to the signal input or signal output is responsible to ensure the system complies with the requirements of the valid version of the system standard IEC 60601-1-1. If you have any questions, please be free to contact our company or customer service. When in doubt, contact our company or customer service.

To ensure accurate readings, consider current environmental conditions and the condition of the patient. See the appropriate sections of the manual for specific safety information related to these conditions.

INTRODUCTION

- INTENDED USE
- ABOUT THIS MANUAL

INTENDED USE

The OMNI II Patient Monitor is a comprehensive monitoring system compiling, processing, analyzing and displaying data from up to nine different patient parameters. It integrates parameter measuring modules, display and printer in one device, and is compact, lightweight and portable. Built-in battery facilitates portability.

The purpose and function of the OMNI II Patient Monitor is to monitor ECG, heart rate, NIBP (systolic, diastolic, and mean arterial pressures), SpO₂, respiration, dual temperature, EtCO₂, dual IBP, anesthetic gas (AG) for adult, neonate and pediatric patients in all hospital areas and hospital-type facilities. It may be used during hospital transport and in mobile, land-based environments, such as ambulances.

[WARNING]: The OMNI II Patient Monitor is intended only as an adjunct in patient assessment. It must be used in conjunction with clinical signs and symptoms.

ABOUT THIS MANUAL

This manual explains how to set up and use the OMNI II Patient Monitor. Important safety information relating to general use of the OMNI II appears before this introduction. Other important safety information is located throughout the text where applicable. **Read the entire manual including the Safety Information section before you operate the monitor.**

CONTROLS, INDICATORS, AND SYMBOLS

- FRONT PANEL
- LEFT SIDE PANEL
- RIGHT SIDE PANEL
- REAR PANEL
- SYMBOLS

FRONT PANEL

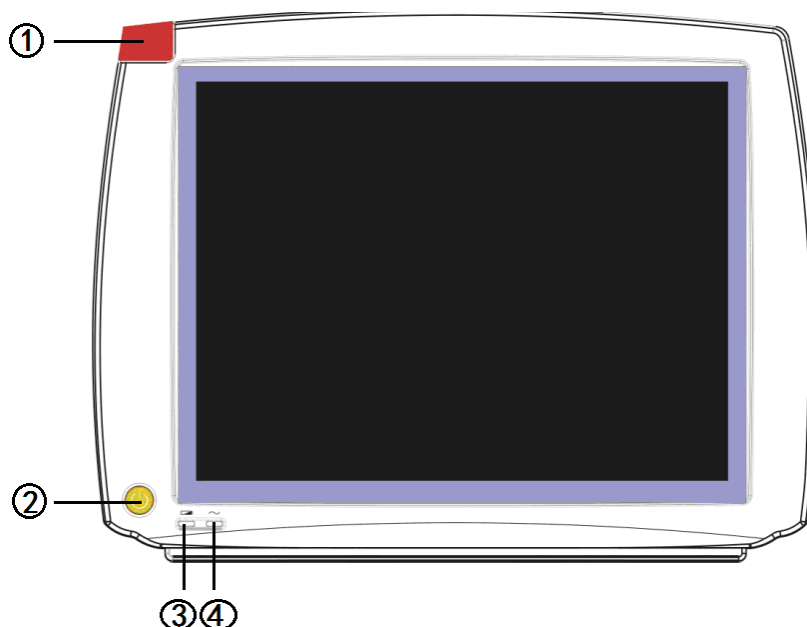
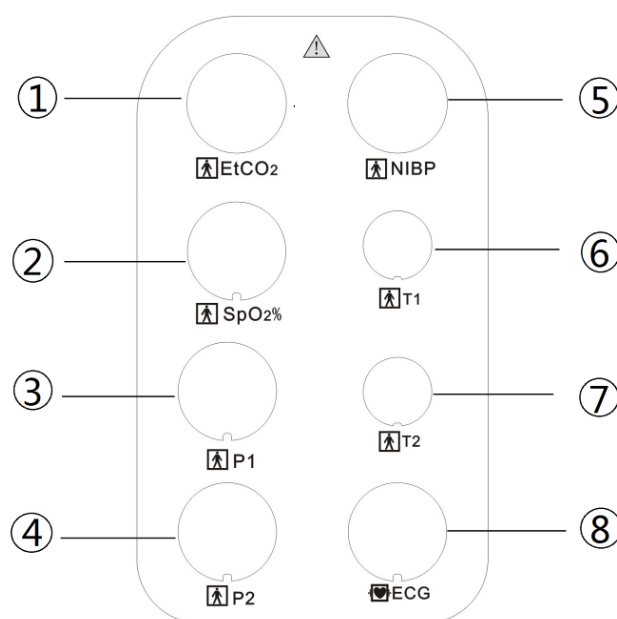

Figure 1: Front Panel

No	FUNCTION	Icon
1	ALARM INDICATOR In normal mode, no indicator lights. In alarm mode, the alarm indicator lights up flashes.	
2	POWER SWITCH This toggle switch turns the secondary power from on to off. The monitor will continue to charge the battery as long as the AC cable is plugged in, even if the power switch is turned the off.	
3	DC ON This LED indicates that the monitor is powered by battery.	
4	AC ON This LED indicates that the monitor is plugged in to AC.	

LEFT SIDE PANEL**Figure 2: Left Side Panel**

No	FUNCTION
1	AG/EtCO ₂ Sensor Socket (Option)
2	Oxygen Saturation Sensor Socket
3	Channel 1 IBP Port (Option)
4	Channel 2 IBP Port (Option)
5	NIBP Socket
6	Channel 1 Temperature Probe Socket
7	Channel 2 Temperature Probe Socket
8	AAMI ECG Cable Connector

RIGHT SIDE PANEL

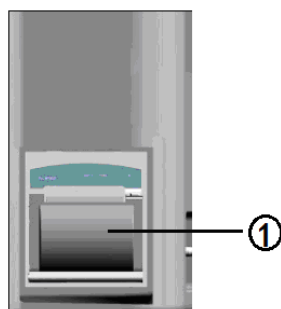

Figure 3: Right Side Panel

No	FUNCTION
1	Printer (Option)

REAR PANEL

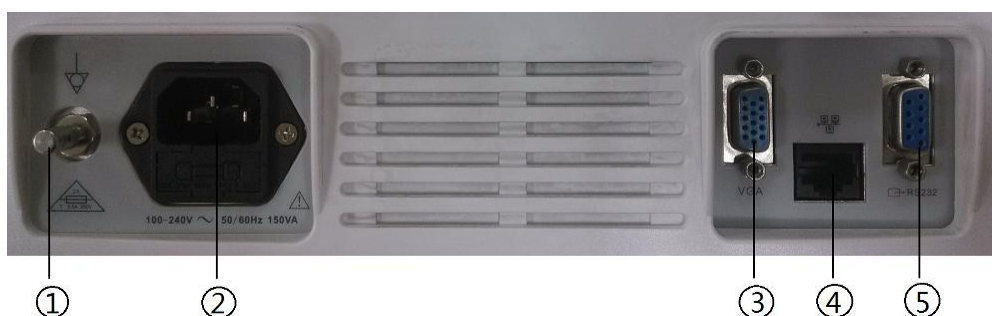



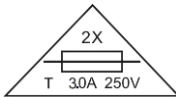





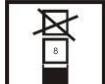









Figure 4: Rear View for Main Unit

No	FUNCTION	Icon
1	Equipotentiality Ground Solve the ground loop and mains problem by designing several alternate courses for electrical energy to finds its way back to ground.	
2	AC Input The AC power connection is where the power cord is connected to the monitor, The AC power fuse must be replaced with the same type of fuse.	100-240V ~ 50/60Hz, 150VA
3	Peripheral VGA display connector	 VGA
4	Ethernet Interface RJ45 interface, used to connect Central Station and Patient Monitor. It also can be used for upgrade system.	
5	RS-232 I/O This digital interface connector provides serial data to most RS-232 devices. Used for communication interface and upgrade system	 RS232

SYMBOLS

The following symbols may appear on the packaging, monitor or in user's manual:

	Type BF Applied Part
	Defibrillation-Proof Type CF Applied Part To identify a defibrillation-proof type CF applied part complying with IEC 60601-1. Note 1 - C = Cardiac. Note 2 - F = Floating Applied Part.
	Rechargeable Battery To indicates the positioning of the cells.
SN	Manufacture's Serial Number
	Fuse Information
	Date Of Manufacture
	Manufacturer
	Fragile Contents of the transport package are fragile; therefore it should be handled with care.
	This Way Up Indicates correct up right position of the transport package.
	Keep Away From Rain Transport package should be kept away from rain.
	Stacking Limit By Number Maximum number of identical packages that may be stacked on one another is eight.
	General Warning, Caution, Risk Of Danger Please read the instructions carefully before operating the product.
	Stand-by To identify the switch or switch position by means of which part of the equipment is switched on in order to bring it into the stand-by condition.
	To signify that the instruction manual/booklet must be read
	Separate collection for waste of electrical and electronic equipment. Do not dispose of battery in municipal waste. The symbol indicates separate collection for battery is required.
	Indicates the temperature limits to which the medical device can be safely exposed

	Indicates the range of humidity to which the medical device can be safely exposed
IPX1	IPX1: N1=X, which means it was not required; N2=1, Protection against vertically falling water drop
Rx Only	Caution: Federal law (USA) restricts this device to sale by or on the order of a licensed healthcare practitioner.
	A marking by which a manufacturer indicates that a device is in conformity with the applicable requirements set out in this Regulation and other applicable Union harmonization legislation providing for its affixing

DISPLAY SCREEN PARTITION

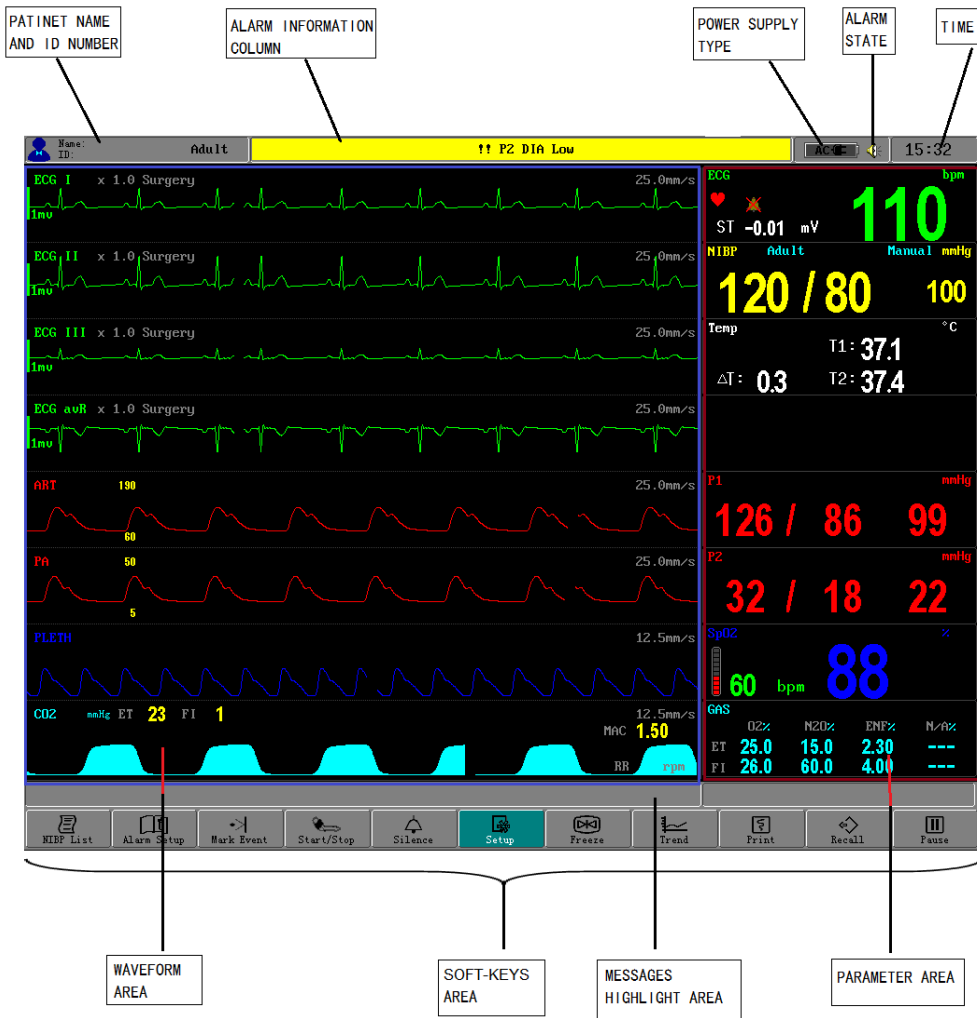

Figure 5: Display Screen

All TFT display screen is divided into three areas:

WAVEFORM AREA

This area will display the waveforms: ECG, PLETH, RESP, ART, PA, EtCO₂, Gas and so on. The waveform channel number is determined by the choice of Display Mode. Displaying waveforms are dependent on the choice of Waveform Select. And also, the user can use the menu to distribute the combination of window waveforms and oxyCRG.

PARAMETER AREA

This area consists of HR, RESP, SpO₂, TEMP, NIBP(SYS, DIA, MAP), EtCO₂, Gas and so on. The user can use menu to choose the combination of window Parameters and NIBP data list.

MESSAGE AREA

Time, Patient Information, Power State and some prompt information are listed here.

Assuming the main screen is being displayed, touch each menu item, it can open the corresponding menu for setup. Access to selected item (and enter submenu if available), once a selection has been made, touching the selected item will exit from menu item (or submenu) and register the current selection. If you want to exit from menu, just touch the menu item of EXIT or OK (or CANCEL).

SYSTEM SETUP

System Setup includes: Factory Setup, Optional Module, Waveform Select, Printer, Config Manager, Drug Calculation, Hemodynamic, Language, Display Mode, Alarm Suspend, Sweep Direction and etc.

Press the button of **SETUP** to pop up the menu below:

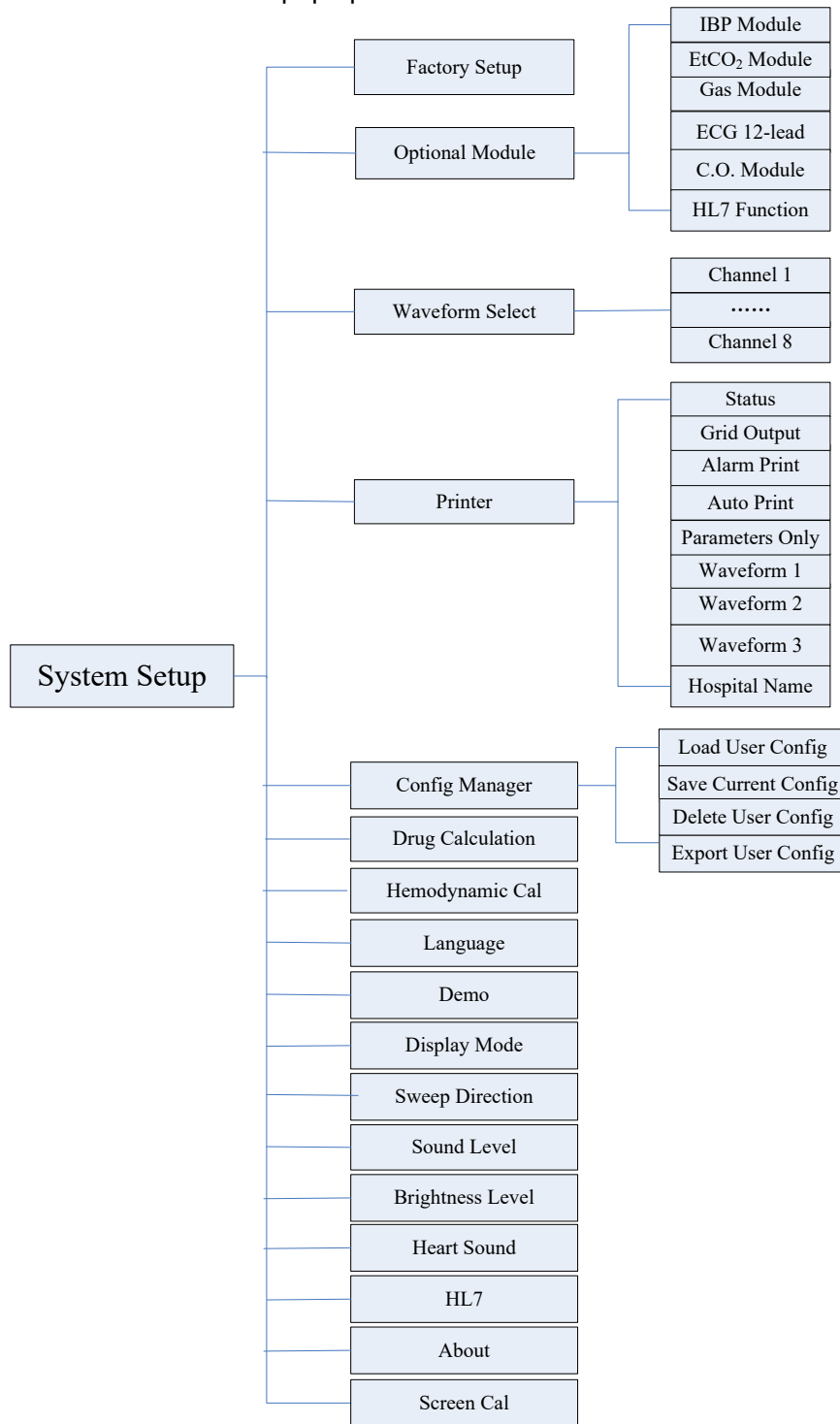

Figure 6: Tree Diagram for System Setup Menu

FACTORY SEVICING SETUP

Servicing engineers use only.

1. If inputting "IP SETUP" for the password, the window for Ethernet IP address setup of the Patient Monitor will open. It is used to connect the Patient Monitor and the Central Station. This IP address is available only when the patient monitor is re-powered on.
2. If inputting "NUIPSET." for the password, you can set the remote address, which should be as same as server IP when you upgrade the program using Ethernet.

OPTIONAL MODULE

You can input different passwords to open the relevant modules such as IBP, EtCO₂, Gas, 12-Lead ECG and HL7 interface.

WAVEFORM SELECT

Select **WAVEFORM SETUP** item to pop up the menu of system Setup.

The waveforms from top to bottom can be selected from ECG I, ECG II, ECG III, ECG avR, ECG avL, ECG avF, ECG V, Pleth, Resp, IBP1, IBP2, EtCO₂, and AG.

The IBP1, IBP2, EtCO₂, AG can be chosen only when the related module is opened. If the ECG Lead Type is 12-lead, screen can display full 12-lead ECG waveforms.

PRINTER

Select the **PRINTER** item in the SYSTEM SETUP menu to finish the settings below.

STATUS

Use to display the connecting state of printer: Connected or Disconnected.

GRID OUTPUT

Set to ON to make waveform print out have a net background, just like record paper.

ALARM PRINT

If this item is set to ON, the monitor will print a 8 seconds slip of waveform (the preceding 4 seconds before the recording till the current 4 seconds) when an alarm is triggered.

AUTO PRINT

Available intervals are every 5 minutes, 10 minutes, 20 minutes, 30 minutes and 60 minutes, if the "Parameters Only" menu item is selected, then after related interval, the monitor will automatically print only Parameters' values. If it is set to off, it will print Waveform and Parameters' values automatically. By turning auto print "OFF", printing will only occur when manually executed.

PARAMETERS ONLY

If this item is set to ON, the monitor will print only the Parameters' values. For example, it will only print the values of HR, NIBP, RR, SpO₂, IBP1, IBP2, ST, T1, T2, EtCO₂, nN₂O, inENF and expENF and so on.

WAVEFORM 1 or 2 or 3

This item is to choose what waveform is to be printed out.

HOSPITAL NAME

Click this item to input or change the hospital name. When clicking the input name location, a keypad will display, and you can select any letter on it as in the following illustration:

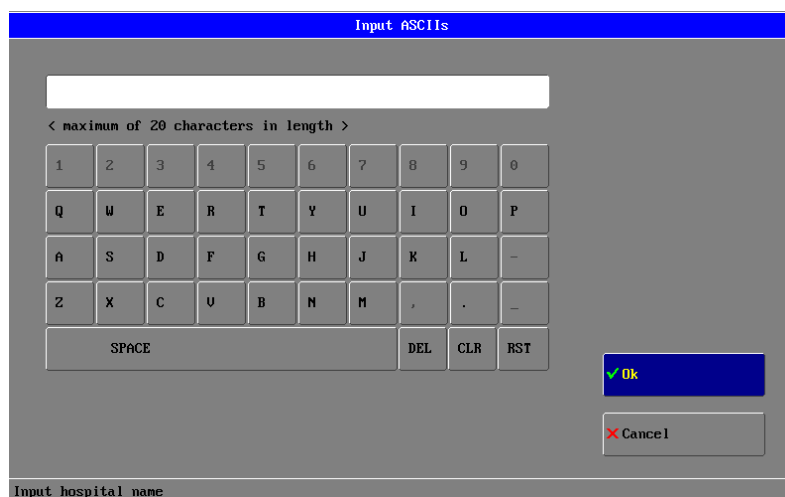

Figure 7: Keypad to input ASCII's

CONFIG MANAGER

LOAD USER CONFIG

If the parameter settings are invalid, you can call the Default Config to recover the original settings. You can also choose the settings that have been saved by yourself. The screen will display a menu to let you confirm the setup.

After return to the above confirmation menu, a message of “Load Configuration Data Success” will display in the message highlight area, showing that the system has begun to work with the new settings.

SAVE CURRENT CONFIG

You can change monitor settings as required and then save the changed settings into a user configuration so that the system can call up these settings the next time they are needed. You will be asked to input the user's name in order to distinguish different settings. The Patient Monitor can save multiple user configurations. The screen will display a menu to let you confirm the setup:

After returning to the above confirmation menu, a message of “Config Data Saved” will display in the message highlight area, showing that the system and all monitoring parameter settings have been saved (see each chapter).

[NOTE]

Make sure that the changes are suitable for your patient.

DELETE USER CONFIG

Delete the previously saved user config.

DRUG CALCULATION

Refer to the CALCULATION section for details.

HEMODYNAMIC CAL

Refer to the CALCULATION section for details.

LANGUAGE SETUP

Use to select language for the monitor system. The language can be switched only after inputting the correct password of “language”.

DEMO DISPLAY

The Demo mode is for demonstration purposes only. To prevent the simulated data being mistaken for the monitored patient's data, you must not change into demo mode during monitoring, otherwise, improper patient monitoring and delayed treatment could result.

This function is for servicing engineers only.

OTHER SETUP

BRIGHTNESS LEVEL

Set the brightness level for screen display. There are ten levels for choice, I, II, III, IV, V, VI, VII, VIII, IX and X. The larger the value is, the brighter the screen is IX.

SOUND LEVEL

I, II, III, IV and OFF for choice. IV is the loudest sound.

HEART SOUND

QRS, Pulse, IBP1, IBP2 or OFF for choice, the factory setting is **QRS**.

HOW TO MONITOR

1. Depending on the parameter needed, connect the correlated sensors to the sockets on the left panel;
2. Connect to the power supply, and press the power switch in the front panel;
3. Power indicator should light up, and the display screen will enter the main screen after 25 seconds;
4. Connect the detector with the patient;
5. Set monitoring parameters (see chapters below) ;
6. Enter the monitoring state.

[CAUTION]: If the OMNI II is to be stored for a period of 2 months or longer, notify service personnel to remove the battery from the monitor prior to storage. Recharge the battery when the battery has not been recharged for 2 or more months.

[CAUTION]: Follow local government ordinances and recycle instructions regarding disposal or recycling of device components, including batteries.

DISPLAY MODE

- OXYCRG SCREEN
- LARGE FONT SCREEN

OMNI II Patient Monitor has five modes for display: 8 Waveforms, 6 Waveforms, 3 Waveforms, Large Font and oxyCRG.

In addition, when the module for 12-Lead is opened, you can also choose the display mode for Full 12-Lead ECG.

When the Lead Type is 3 Leads, the default display mode is 3 Waveforms and the 8 Waveforms display mode is not available. When the Lead Type is 5 Leads, the default display mode is 6 Waveforms; when the Lead Type is 12 Leads, the default display mode is Full 12-Lead. You can also set the display mode as required.

OXYCRG SCREEN

To have a split screen view of oxyCRG, you could select Display Mode for oxyCRG. The interface is as below:

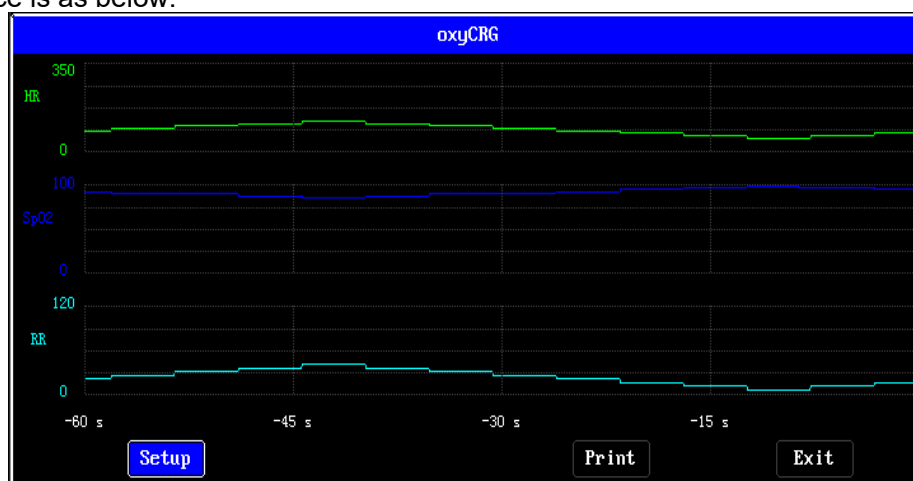

Figure 8: Window for oxyCRG

The split screen view covers the lower part of the waveform area and shows HR Trend, SpO₂ Trend and RR Trend (or Resp Waveform). At the bottom, there are controls as below:

OXYGEN SETUP

TIME

In the time menu, you can select 1 minute, 2 minutes, 4 minutes and 8 minutes

RR/RESP

You can select either RR Trend or Resp Waveform for display.

PRINT

With this soft-key, you can print out the currently displayed oxyCRG trends by the printer.

LARGE FONT SCREEN

To enter the big numeric screen: select the Display Mode for Large Font. The interface is as below:



Figure 9: Window for Large Font

You can select your desired parameters to be display in this screen.

In the Waveform Select menu, you can select the waveform related to the parameter you want. For example: if you want to display the big numeric of SpO₂ value and PR value in the screen, you could select the Pleth in the channel1 or other channel. For parameters having a waveform, the waveform will also be displayed.

[NOTE]: The first ECG Waveform is corresponding to the HR Value. The second ECG Waveform corresponds to the NIBP Value. The third ECG Waveform corresponds to the Temp Value. The other ECG Waveform does not correspond to anything

ALARM & SOUND

ALARM

When the monitor detects certain conditions that require user attention, the OMNI II Patient Monitor enters an alarm state. The monitor response will include:

- Visual alarm indicators
- Audible alarm indicators
- Print-on-alarm (if printer installed)
- Identification of out-of-limit vital signs in trend data

The monitor's visual and audible responses to a detected alarm depend on the priority of the alarm; Urgent, High, Medium, or Low.

A higher priority alarm will supersede a lower priority alarm.

The four categories of alarms are summarized in the following tables. The text indicates the message shown on the screen.

Alarm Priority	Alarms	Remarks
Urgent Level	Asystole	Indicates that immediate response from the operator is required.
High/Medium Level (Adjustable)	High/Low numeric value limits have been violated for the following parameters: HR, ARR, ST, SpO ₂ , PR, Resp, NIBP, Temp, IBP and EtCO ₂	Indicates that prompt response from the operator is required.
Low Level	Sensor or lead(s) off (such as ECG Leads Off, SpO ₂ Cable/Sensor Disconnect, Temperature Probe Disconnect, etc.) Low battery Communications errors for the modules	Indicates that awareness from the operator is required.

ALARM SETUP

ALARM PRIORITY

In this menu, you can set the alarm priority, which is invoked when the High/Low numeric value limits have been violated for the following parameters: HR, ARR, ST, SpO₂, PR, Resp, NIBP, Temp, IBP and EtCO₂. Each priority has two items for choice, High and Medium. The default priority in this menu is Medium.

ALARM LIMITS

In this menu, you can set all the Parameters' Alarm Limits as you require. The settings here are equivalent to those set in the relevant Parameter Setup Menu and are kept in sync.

[WARNING]: Before using the monitor each time, check alarm limits to ensure that they are appropriate for the patient being monitored.

VISUAL ALARM INDICATORS

When an alarm occurs, the OMNI II responds with visual alarm indicators. If more than

one similar level alarm is present, the alarm messages will rotate. The flashing rates for the four categories of alarms are shown below.

Alarm Priority	Indicator Color	Flashing Rate
Urgent/High Level	Red Color	Two flashes in 1 second
Medium Level	Yellow	One flash in 2 seconds
Low Level	Yellow	Constant (on) (non-flashing)

When the high-priority Asystole alarm occurs, the HR value display '---' and the corresponding bell icon flash at the high priority rate. The background color of the Alarm Information Column will flash red for a high priority alarm in the OMNI II. A non-flashing Asystole message appears in the message area and will override any other messages that may be present (there is no message "rotation" in this case).

A medium priority alarm is activated when a parameter is outside its alarm limits. The parameter value and the bell icon in the corresponding numeric frame will flash at the medium priority rate. The background color of the Alarm Information Column will flash yellow for a medium priority alarm in the OMNI II.

When a low level alarm occurs, a non-flashing alarm message appears in the message area. The background color of the Alarm Information Column will change to a solid blue-green.

ALARM SUSPEND

If you want to prevent alarms temporarily from sounding, you can suspend alarms by pressing the soft-key or hard-key "Silence". When alarms are suspended:

- No alarm lamps flash and no alarms are sounded.
- No alarm messages are shown.
- The remaining pause time is displayed in the alarm prompt area.

During Alarm Suspend, monitoring continues for all parameters; the numeric values and waveforms continue to operate normally. Trend memory operates normally. The single-function buttons continue to operate normally.

The Patient Monitor enters into the alarm paused status as soon as it is turned on. The user can set the suspend time in the Alarm Suspend Menu. There are four choices: 1 minute, 2 minutes, 3 minutes, Permanent.

When the alarm pause time expires, the alarm suspended status is automatically cancelled. Also you can press the "Silence" key to terminate the alarm suspended condition. If you choose "Permanent", it means that the alarms will be suspended permanently.

[WARNING]: DO NOT switch off or pause or decrease the volume of the alarm if patient safety could be compromised.

ALARM SWITCH

When any alarm switch is set to **OFF**, the alarm indicator will not light up, the relative alarm parameter will not flash and the  icon will appear in the relative parameter area.

SOUND

ALARM SOUND

There are four alarm levels to choose from, ranging from low to high: *I*, *II*, *III* and *IV*.

The following encoded auditory alarm signals can be categorized by alarm condition and priority:

Alarm Category	Encoded Auditory
High Priority	c c c-c c
Medium priority	c c c
Low priority	e C
<p>[NOTE 1]: The characters c,e refers to relative musical pitches and C is one octave c.</p> <p>[NOTE 2]: A high priority alarm signal is generated with the five pulses, repeat once, for total of 10 pulses.</p>	

HEART-BEAT (PULSE-TONE)

The heartbeat or pulse-tone is a sound of RUB-A-DUB. In the Setup menu, you may choose QRS, PULSE, IBP1, IBP2 and OFF, and when the choice is QRS, the system will use the heartbeat sound. When the choice is PULSE, the system will use the pulse-tone sound and the sound frequency will change with the SpO₂ Value. When the choice is IBP1 or IBP2, the system will use the IBP sound. When the choice is OFF, the system will close the heartbeat sound or pulse-tone or IBP.

KEY BEEPS

The key beep sounds come along with clicking function items.

SILENCE

Click this function button to disable all sounds except for the key beeps. The  symbol will display in the message area. Click this button again to restore all sounds except for the key beeps.

ECG MONITORING

- ELECTRODE INSTALLATION
- CABLE AND LEADWIRE INSTALLATION
- ECG SETUP
- ST-SEGMENT ANALYSIS
- ARRHYTHMIA ANALYSIS
- 12-LEAD ECG MONITORING
- ERROR MESSAGES OF ECG MONITORING
- MAINTENANCE AND CLEANING

ELECTRODE INSTALLATION

Some points should be paid special attention to in ECG monitoring:

1. Check the lead and cable. Damaged or ruptured ones cannot be used.
2. Link up the lead set and cable, and connect the electrode to the lead.
3. Choose the suitable skin area on which the electrode should be pasted. Use alcohol to clean the skin. Paste the electrode on the patient and check that they are well contacted.
4. The electrodes must be removed away to check the skin every 24 hours. If the skin is found to be inflamed or damaged, put a new electrode in another position.
5. Make sure no conductive part of electrodes is in contact with the ground or other conductive materials.

5-Leadwire Electrode Placement

Follow the methods below to place the 5-lead electrode.

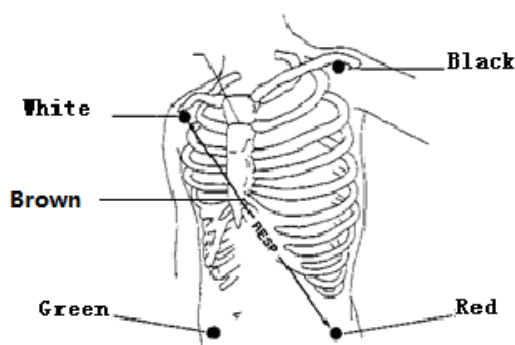

Figure 10: 5-lead Electrode Placement

- WHITE (RIGHT ARM) ELECTRODE (RA)—is placed near the right shoulder, directly below the clavicle.
- BLACK (LEFT ARM) ELECTRODE (LA)—is placed near the left shoulder, directly below the clavicle.
- GREEN (REFERENCE) ELECTRODE (RL)—is placed on the right hypogastria.
- RED (LEFT LEG) ELECTRODE (LL)—is placed on the left hypogastria.
- BROWN(CHEST)ELECTRODE(V or C)-is placed on the chest as illustrated below:

[NOTE]

- Only the ECG cable presented by our factory can be used.
- To ensure patient safety, all leads must be attached to the patient.

For 5-lead set, attach the C-electrode to one of the indicated positions as below:

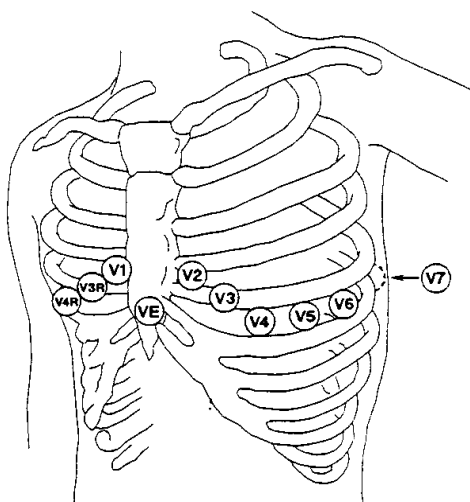

Figure 11: C-electrode Placement

- V1** is on the 4th intercostal space at the right sterna margin.
- V2** is on the 4th intercostal space at the left sterna margin.
- V3** is at the midway between V2 and V4 electrodes.
- V4** is on the 5th intercostal space at the left clavicular line.
- V5** is on the left anterior axillary line, horizontal with the V4 electrode.
- V6** is on the left middle axillary line, horizontal with the V4 electrode.
- V3R-V7R** is on the right side of the chest in positions corresponding to those on the left.
- VE** is over the xiphoid. As for the V-lead position on the back, it should be placed at one of the positions below.
- V7** is on the 5th intercostals space at the left posterior axillary line of back.
- V7R** is on the 5th intercostals space at the right posterior axillary line of back.

12-Leadwire Electrode Placement

12-lead ECG uses 10 electrodes, which are placed on the patient's four limbs and chest. The limb electrodes should be placed on the soft skin and the chest electrodes should be placed according to the physician's preference.

Lead Placement for Surgical Patients

The surgical site should be taken into consideration when placing electrodes on a surgical patient. E.g. for open-chest surgery, the chest electrodes can be placed on the lateral chest or back. To reduce artifacts and interference from electrosurgical units, you can place the limb electrodes close to the shoulders and lower abdomen and the chest electrodes on the left side of the mid-chest. Do not place the electrodes on the upper arm. Otherwise, the ECG waveform will be very small.

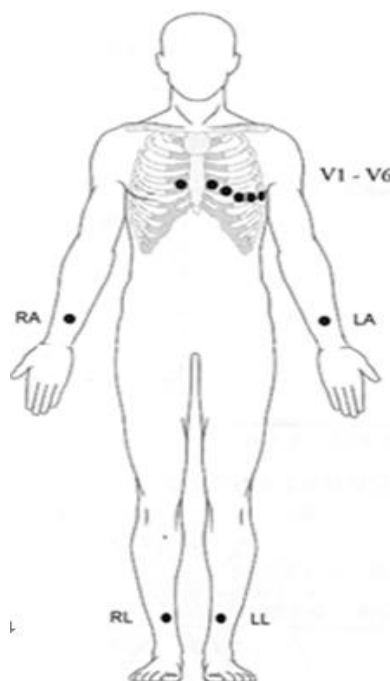

Figure 12: 12-Lead Electrode Placement

[WARNING]:

- When using electrosurgical units (ESU), patient leads should be placed in a position that is equidistant from the Electrosurgery electrotome and the grounding plate to avoid burns to the patient. Never entangle the ESU cable and the ECG cable.
- When using electrosurgical units (ESU), never place ECG electrodes near the grounding plate of the ESU, as this can cause a lot of interference on the ECG signal.

CABLE AND LEADWIRE INSTALLATION

1. Insert the plug of ECG into the socket on the left panel of the monitor, and make sure that the salient of plug is direct to the notch of socket when inserting.
2. Connect the electrode lead to the patient's cable.

ECG SETUP

Touch the ECG Waveform or Parameter area directly. This menu has the following settings:

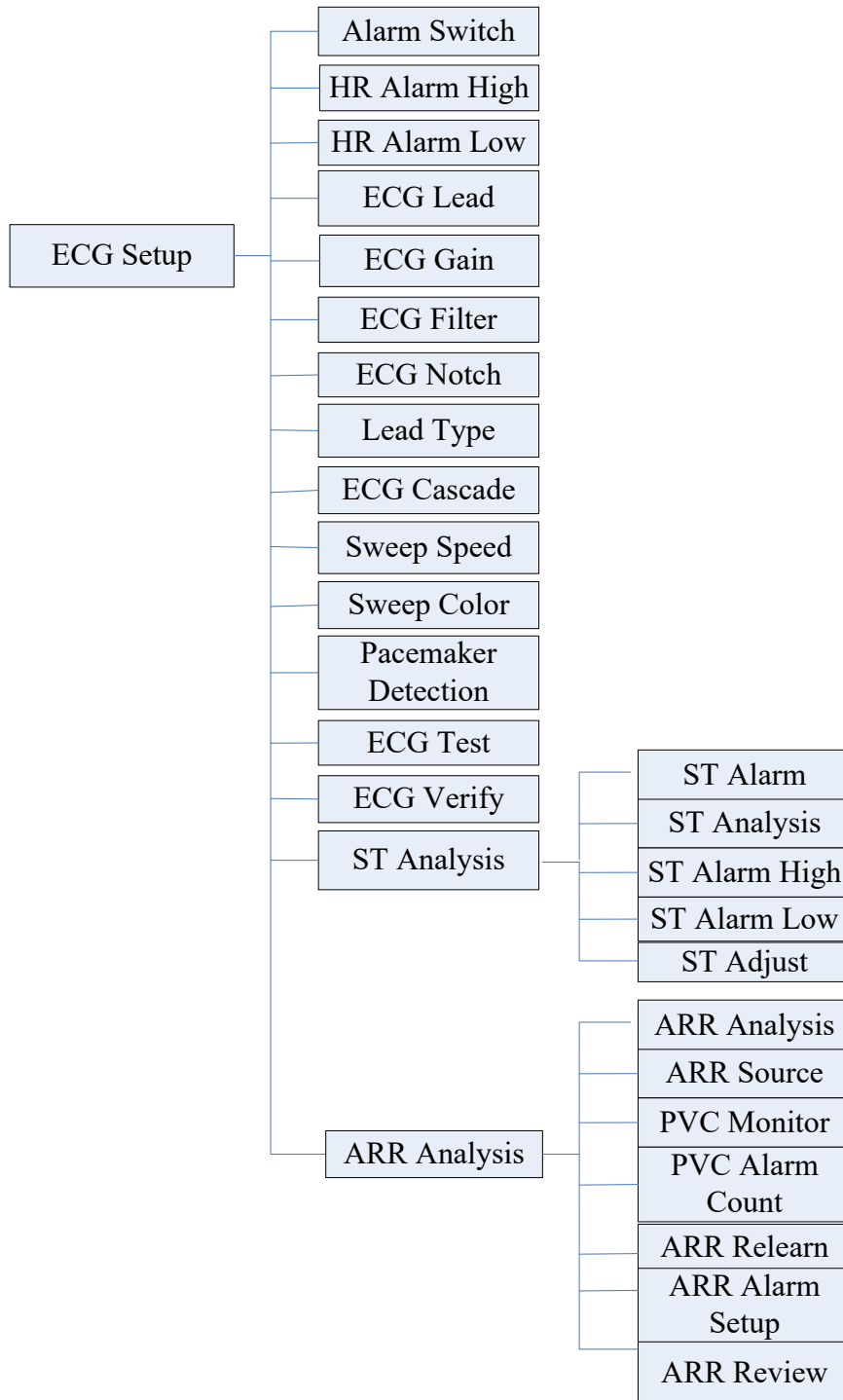



Figure 13: Tree Diagram for ECG Setup

ALARM SWITCH

ON and OFF for choice, the factory setting is **ON**.

If the HR value is above or below the HR alarm limit and the choice is **ON**, then the alarm is activated; when the choice is **OFF**, the alarm indicator will not light up, the relative alarm parameter will not flash and relative parameter area will display the  icon.

HR ALARM HIGH

The range is: **80~400** bpm. The default alarm limit is changed depending on the patient type. When the patient type is adult, the factory setting is **130** bpm; when it is pediatric, the factory setting is **160** bpm; when it is neonatal, the factory setting is **200** bpm. The single-step adjustable step-length is **5** bpm.

HR ALARM LOW

The range is: **20~150** bpm. The default alarm limit is changed depending on the patient type. When the patient type is adult, the factory setting is **50** bpm; when it is pediatric, the factory setting is **75** bpm; when it is neonatal, the factory setting is **100** bpm. The single-step adjustable step-length is **5** bpm.

ECG LEAD

When the Lead Type is 5 Leads or 12 Leads, this item is not selectable. When the Lead is 3 Leads, you can choose it for Lead I or Lead II or Lead III.

ECG GAIN

The user can choose from X0.25, X0.5, X1.0, X2.0, and X4.0. The bigger the gain is, the larger the waveform amplitude is. The factory setting is **X1.0**.

When ECG lead type is 3-Lead, options X0.25, X0.5, X1.0 are available under all Display Modes. Option X2.0 is only available under Display Modes: 3 Waveform, 6 Waveforms and oxyCRG. Option X4.0 is only available under Display Mode: 3 Waveforms.

When ECG lead type is 5-Lead, options X0.25, X0.5, X1.0 are available under all Display Modes. Option X2.0 is only available under Display Modes: 3 Waveforms and 6 Waveforms. Option X4.0 is only available under Display Mode: 3 Waveforms.

ECG FILTER

The ECG Filter setting defines how ECG waveforms are smoothed. The three modes to select from are Surgery, Monitor or Diagnose. The factory setting is Monitor.

- Monitor: Use under normal measurement conditions
- Diagnose: Use when diagnostic quality is required. The unfiltered ECG waveform is displayed so that changes such as R-wave notching or discrete elevation or depression of the ST segment are visible.
- Surgery: Use when the signal is distorted by high frequency or low frequency interference. High frequency interference usually results in large amplitude spikes making the ECG signal look irregular. Low frequency interference usually leads to a wandering or rough baseline. In the operating room, the surgery filter reduced artifacts and interference from electrosurgical units. Under normal measurement conditions, selecting 'Surgery' may suppress the QRS complexes too much and then interfere with ECG analysis.

ECG NOTCH

The notch filter removes the line frequency interference. When the ECG filter is in Monitor or Surgery mode, the notch filter always stays on. Only when the filter is Diagnose mode, can you switch the notch filter on or off as required. ECG notch can be set to 50Hz or 60Hz according to power line frequency. The factory setting is 50Hz.

LEAD TYPE

Choose between 3 leads and 5 leads. The factory setting is 5 leads. 12-lead can be chosen only when the ECG 12-Lead is ON in the Optional Module.

ECG CASCADE

ON or OFF for choice. If the choice is ON, an ECG waveform will take up two channels. After filled up with the first channel, the waveform will follow the second channel. In cascade mode, the waveform can only sweep from left to right. The default setting is OFF.

SWEEP SPEED

Select from 12.5 mm/s, 25 mm/s and 50 mm/s. The factory setting is 25 mm/s.

SWEEP COLOR

Select from White, Gray, Red, Yellow, Green, Cyan, Blue, and Magenta. The default-set is Green.

PACEMAKER DETECTION

It is important to set the paced status correctly when you start monitoring ECG. When the Pacemaker Detection is set to ON, the pace pulse markers “|” are shown on the ECG waveforms when the patient has a paced signal.

[WARNING]

1. For paced patients, you must set Pacemaker Detection to ON. If it is incorrectly set to OFF, the patient monitor could mistake a pace pulse for a QRS and fail to alarm when the ECG signal is too weak. DO NOT rely entirely on alarms when monitoring patients with pacemakers. Always keep these patients under close surveillance.
2. For non-paced patients, you must set Pacemaker Detection to OFF. If it is incorrectly set to ON, the patient monitor may be unable to detect premature ventricular beats (including PVCs) and perform ST segment analysis.

ECG TEST

Used by engineers only.

ECG VERIFY

Used by engineers only.

ST-SEGMENT ANALYSIS

ST-segment analysis calculates ST-segment elevations and depressions for individual leads and then displays them numerically in the ECG Parameter area. A positive value indicates ST-segment elevation; a negative value indicates ST segment depression. This feature is not intended for neonatal patients.

As shown in the figure below, the ST measured for each beat complex is the vertical difference between two measurement points with the R-wave peak as the baseline for the measurement.

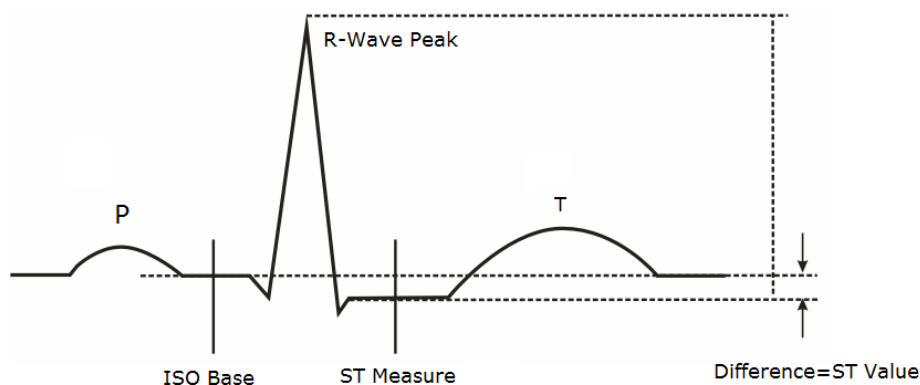

ST ALARM SWITCH

The default value is **OFF**. The alarm is triggered when the ST measurement value exceeds the alarm limits. If the ST Alarm is **ON**, the ST value blinks, the alarm sounds, the alarm indicator flashes, and the information column will show **ST HIGHER** or **ST LOWER**.

ST ALARM LIMIT

Set the ST alarm upper limit and lower limit separately. The range is: **-2.00~2.00** mV. The default upper limit is +0.30 mV, and the default lower limit is -0.30 mV. The single-step adjustable step-length is **0.02** mV.

ST ANALYSIS SWITCH

The default value is **OFF**, only choosing **ON** can enable the ST Segment Monitoring. Meanwhile, the **TREND GRAPH** or **TREND TABLE** can be opened by selecting **TREND** to see the tendency displaying on the graph or table.

ST ADJUST

ISO (Base Point)

Set the baseline point. The adjustable range is **-508 ms~ -4 ms**, and the default value is **-80ms**, indicating that the reference point is the position located 80ms before the peak of R-wave.

ST (Measurement Point)

Set the measuring point. The adjustable range is **+8 ms~ +508 ms**, and the default value is **+108ms**, showing that the reference point is the position located 108 ms after the peak of R-wave.

These two points can be adjusted by clicking the **<<** or **>>** buttons. The value and the indicating line will change simultaneously.

[NOTE]: The ST measurement point should be adjusted if the patient's HR or ECG morphology changes significantly.

ARRHYTHMIA ANALYSIS

The monitoring system supports the self-relearn function to accommodate itself to new conditions such as different patients. The user can edit the arrhythmia type. For each type, the system saves 8 items for arrhythmia and in total saves 104 items.

[WARNING]:

The Arrhythmia analysis program is intended to detect ventricular arrhythmias. It is not designed to detect atrial or supraventricular arrhythmias. It may incorrectly identify the presence or absence of an arrhythmia. Therefore, a physician must analyze the arrhythmia information with other clinical findings.

ARR SOURCE

Select between **lead I**, **lead II** and **Lead III**. The factory setting is **lead II**. The user can switch the ECG lead if the current lead's signal is weak.

PVC MONITOR

Set PVC monitor to be ON or OFF. The factory setting is ON, and if the premature ventricular contraction times exceed the PVC ALARM COUNT, the system will alarm.

PVC ALARM COUNT

The set range is from 1 to 10. The factory setting is 10.

ARR RELEARN

Self relearn to adjust to new conditions. For example, cardiographs can differ dramatically between different patients.

ARR ALARM SETUP

Set each type of the arrhythmia alarms to **ON** or **OFF**. The factory settings are **ON** for all types.

ARR REVIEW

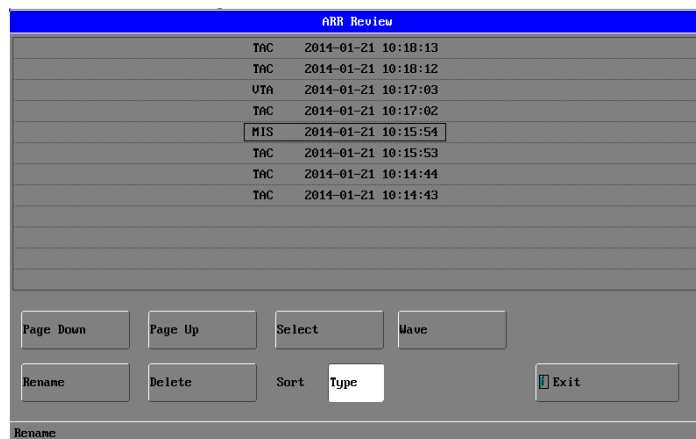

Figure 14: Window for ARR Review

1. **Select:** To choose an arrhythmia item.
2. **Wave:** To review the selected arrhythmia item, including HR, ST, PR, SpO₂, NIBP, Temp, Resp, PVC and so on,

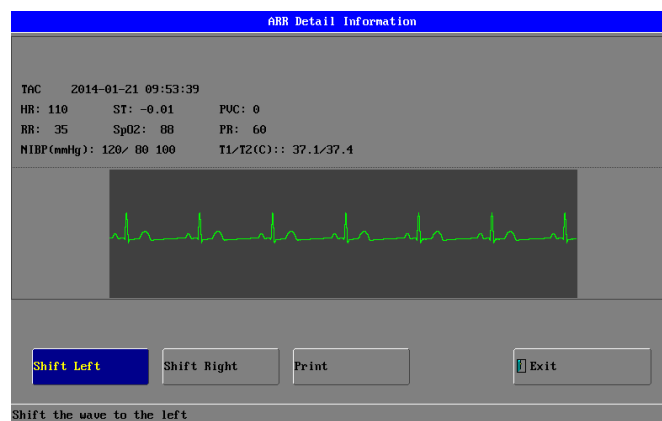

Figure 15: Window for ARR Retail Information

3. **Rename:** To rename a selected ARR item.
4. **Delete:** To delete a selected ARR item.
5. **Sort:** to sort the arrhythmia items by **Time** or **Type**. The factory setting is by Time. Arrhythmia analysis can monitor 13 kinds of arrhythmias. Refer to below.
 1. ASY --- Asystole
 2. VFIB/VTAC --- Ventricular Fibrillation/ Ventricular Tachycardia
 3. PNP --- Pacemaker Not Pace-making
 4. PNC --- Pacemaker Not Captured
 5. VT>2 --- Ventricular Triplet
 6. CPT --- Ventricular Couplet
 7. PVC --- Ventricular Premature Beats
 8. BGM --- Bigeminy
 9. TGM --- Trigeminy
 10. ROT --- R ON T is detected.
 11. TAC --- Tachycardia
 12. BRD --- Bradycardia
 13. MIS --- Miss Beat

12-LEAD ECG MONITORING

Entering the 12-lead ECG Monitoring Screen

1. Enable the 12-Lead ECG function in the Optional Module.
2. Refer to the section on ECG Monitoring and Electrode Installation for placing the electrodes.
3. In the ECG Setup menu, select Lead Type. Then choose 12-Lead.



Figure 16: Window for Full 12-Lead ECG

ERROR MESSAGES OF ECG MONITORING

Sometimes messages will display above the ECG waveform:

Prompts	Explanation
Lead off	ECG leads fall off the skin or the monitor
ECG Signal Weak	Monitor system cannot calculate HR value when the ECG Signal is too weak.

MAINTENANCE AND CLEANING

PATIENT CABLE AND LEAD

After every use, the cable must be cleaned following the methods below:

- Clean the paste off body and the remainder of electrolyte on the electrode. The paste-eradicator can be used when removing the remains of the adhesive tape, but acetone, alcohol, ammonia, chloroform and other strong solvents are not recommended because they could fatally damage the vinyl cable.
- Use a sponge moistened in mild soap liquid or other suitable detergent solution to clean the cable and then dry them. Do not submerge the cable into the water.
- Check each cable to see whether they are corroded, damaged or degenerated. Do not use a pressure cooker to disinfect the cable and electrode or heat them to temperatures at or above 75 °C (167F). If there is dirt on the surface of the material, clean with an abluent that will not leave any residue. Do not use a metal grinding medium like floss. The storing temperature should be between -20 °C and 75 °C (-68F and 167F). Hang or place them flat so they will not be damaged.

ADDING POINTS

- HR calculating stability obeys a specific process. Switching ECG leads sometimes affects HR, but it will eventually stabilize. The change of gain and filter may influence

the HR calculating stability too. Another factor that affects the HR calculation is the QRS waveform: if the T wave is too high, then HR will also be incorrect. Arrhythmia can also influence HR.

- Choosing a suitable ECG waveform range and complete QRS waveform affects the accuracy of HR calculation.

RESP MONITORING

- RESP ELECTRODE INSTALLATION
- RESP SETUP
- MAINTENANCE AND CLEANING

RESP ELECTRODE INSTALLATION

The monitor measures respiration from the amount of thoracic impedance between two ECG electrodes. The change of impedance between the two electrodes (due to the thoracic movement) produces a respiratory waveform on the screen.

For RESP monitoring, it is not necessary to have additional electrodes; however, the placing of electrodes is important.

Some patients, due to their clinical condition, expand their chest laterally, causing a negative intrathoracic pressure. In these cases it is better to place the two RESP electrodes laterally in the right axillary and left lateral chest areas at the maximum point of breathing movement to optimize the respiratory waveform.

The sensor of RESP Electrode's installation is same as ECG's.

[NOTE]

The Resp monitoring is not recommended to be used on patients who are very active, as this can cause false alarms.

The scheme picture for placing the 5 Electrodes for Respiratory Monitoring is as follows:

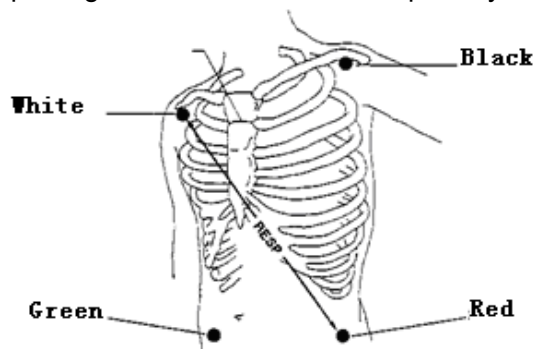

[NOTE]

Place the red and green electrodes diagonally to optimize the respiration waveform. Avoid the liver area and the ventricles of the heart in the line between the RESP electrodes so as to avoid cardiac overlay or artifacts from pulsating blood flow. This is particularly important for neonates.

RESP SETUP

Touch the Resp Waveform Area or Parameter Area directly. You can open the Resp Setup Menu.

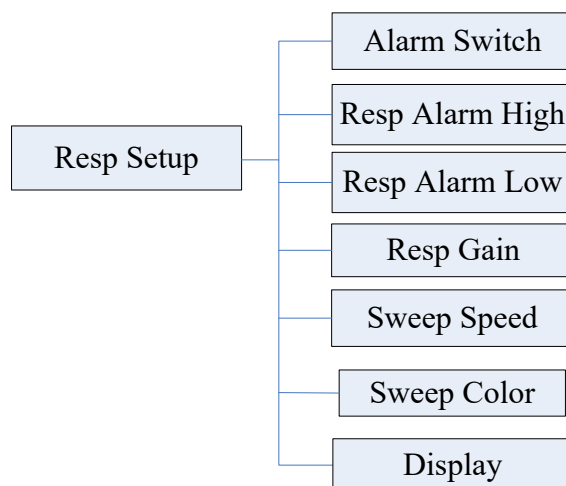



Figure 17: Tree Diagram for Resp Menu

The menu has the following settings:

ALARM SWITCH

ON and **OFF** for choice, the factory setting is **ON**.

If the RESP value is above or below the RESP alarm limit, when the choice is **ON**, the alarm is activated; when the choice is **OFF**, the alarm indicator will not light, the relative alarm parameter will not flash and relative parameter area will display the  icon.

RESP ALARM HIGH

The RESP alarm upper-limit, the range is **8~120** rpm. The default alarm limit is changed with different patient type. When the patient type is adult or pediatric, the factory setting is **30** rpm; when it is neonatal, the factory setting is **100** rpm. The single-step adjustable step-length is **1** rpm.

RESP ALARM LOW

The RESP alarm lower-limit, the range is **6~100** rpm. The default alarm limit is changed with different patient type. When the patient type is adult or pediatric, the factory setting is **8** rpm; when it is neonatal, the factory setting is **30** rpm. The single-step adjustable step-length is **1** rpm.

RESP GAIN

The user can freely choose one from items of **X0.25**, **X 0.5**, **X1.0** and **X2.0**. The bigger the gain is, the larger the waveform amplitude is. The factory setting is **X1.0**.

SWEEP SPEED

Choose from **6.25** mm/s, **12.5** mm/s and **25.0** mm/s, and the factory setting is **6.25**mm/s.

SWEEP COLOR

From White, Gray, Red, Yellow, Green, Cyan, Blue, and Magenta for choice, the default setting is Cyan.

DISPLAY

The **ON** and **OFF** for choice. Pick **ON** can display Resp measured value, pick **OFF** would not display the Resp value, but this do not influent the actual data of trend.

Applications: when the patient's thorax or abdomen is subjected too much interference, the Resp monitoring is not accurate, so it is suggested to close the Resp display.

MAINTENANCE AND CLEANING

It is the same as the ECG monitoring.

SPO2 MONITORING

- SPO2 MONITORING PRINCIPLE
- SPO2 SENSOR INSTALLATION
- SPO2 SETUP
- MEASUREMENT LIMITATIONS
- SPO2 ERROR MESSAGES
- MASIMO INFORMATION
- NELLCOR INFORMATION

SPO2 MONITORING PRINCIPLE

Arterial oxygen saturation is measured by a method called pulse oximetry. It is a continuous, non-invasive method based on the different absorption spectra of reduced hemoglobin and oxyhemoglobin. It measures how much light, sent from light sources on one side of the sensor, is transmitted through patient tissue (such as a finger or an ear), to a receiver on the other side.

The amount of light transmitted depends on many factors, most of which are constant. However, one of these factors, the blood flow in the arteries, varies with time, because it is pulsating. By measuring the light absorption during a pulsation, it is possible to derive the oxygen saturation of the arterial blood. Detecting the pulsation gives a PLETH waveform and pulse rate signal.

About SpO₂, SaO₂, SjvO₂

- SpO₂: It is the arterial blood oxygen saturation level measured by oximeter.
- SaO₂: It is the oxygen saturation of arterial blood
- SjvO₂: It is the oxygen saturation of the jugular blood.

[WARNING]

Pulse oximeter can overestimate the SpO₂ value in the presence of HB-CO, Met-HB or dye dilution chemicals.

SPO2 SENSOR INSTALLATION

1. Insert the plug of SpO₂ sensor into the SpO₂ socket on the left panel of monitor. Make sure that the salient of plug must direct to the notch of socket when inserting or unplugging, otherwise the measurement will not be reliable and the sensor connector will be damaged.
2. Wear the finger-probe on the finger; make sure that the finger tip is the same direction as the finger direction indicated on the probe.

SPO2 SETUP

Touch the SpO₂ Waveform or Parameter area directly. As graph below:

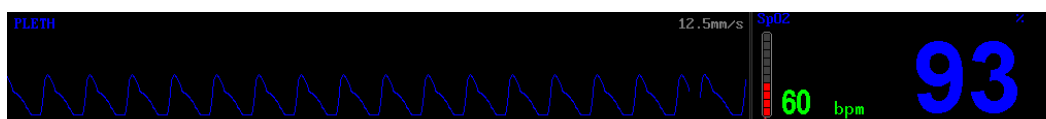

PULSE BARGRAPH
Use red bargraph to express the intensity of the pulse of patient.

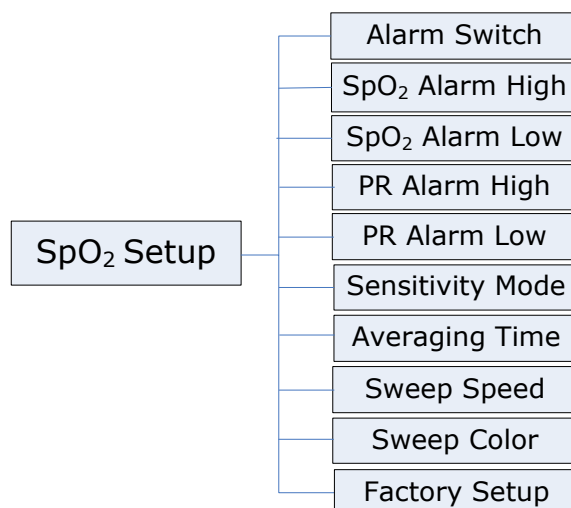



Figure 18: Tree Diagram for SpO₂ Setup Menu

The menu has the following settings:

ALARM SWITCH

ON and **OFF** for choice, the factory setting is **ON**.

If the SpO₂ value is above or below the SpO₂ alarm limit, when the choice is **ON**, the alarm is activated; when the choice is **OFF**, the alarm indicator will not light, the relative alarm parameter will not flash and relative parameter area will display the  icon.

SPO2 ALARM HIGH

Set the SpO₂ alarm upper-limit. The range is **50~100** %, and the factory setting is **99%**, and the single-step adjustable step-length is **1** %.

SPO2 ALARM LOW

Set the SpO₂ alarm lower-limit. The range is **50~100** %, and the factory setting is **85%**, and the single-step adjustable step-length is **1%**.

PR ALARM HIGH

Set the PR alarm upper-limit. The range is **70~239** bpm, and the factory setting is **130** bpm, and the single-step adjustable step-length is **1** bpm.

PR ALARM LOW

Set the PR alarm lower-limit. The range is **20~150** bpm, and the factory setting is **50** bpm, and the single-step adjustable step-length is **1** bpm.

SENSITIVITY MODE

This item is adjustable only when the SpO₂ module is Masimo. According to the patient status, you could choose different sensitivity mode. The default setting is APOD.

- **Maximum Mode:** This mode should be used for the sickest patients, where obtaining a reading is most difficult. Maximum Sensitivity is designed to interpret and display data for even the weakest of signals. This mode is recommended during procedures and when clinician and patient contact is continuous.
- **Normal Mode:** This mode provides the best combination of sensitivity and probe-off detection performance. This mode is recommended for the majority of patients.
- **APOD (Adaptive Probe Off Detection) Mode:** This mode is the least sensitive in picking up a reading on patients with low perfusion but has the best detection for probe-off conditions. This mode is useful for patients that are at particular risk of the sensor becoming detached (Pediatric, combative, etc.).

AVERAGING TIME

Set the averaging interval time to obtain SpO₂ value from Masimo module. This item is adjustable only when the SpO₂ module is Masimo. You could choose 2-4s, 4-6s, 8s, 10s, 12s, 14s and 16s.

SWEEP SPEED

Choose from **12.5 mm/s** to **25.0 mm/s**, and the factory setting is **12.5 mm/s**.

SWEEP COLOR

Choose from White, Gray, Red, Yellow, Green, Cyan, Blue, and Magenta. The default setting is Blue.

SPO2 FACTORY SETUP

Click System "**Factory Setup**" and input the password "SPO2...". You will then enter the "SpO₂ Setup" Menu to complete the SpO₂ Factory Setup.

There are three SpO₂ modules to choose from: Infinium, Nellcor and Masimo. For more detail please contact local distributor or service engineer

This item is for servicing engineer use only.

MEASUREMENT LIMITATIONS

1. The measurement is determined by the pulse of the blood flow in the arterial blood vessels. The arterial blood flow may decrease to such a level that it cannot be measured under the following conditions:
 - Shock
 - Hypothermia
 - Vasoactive medicines are applied
 - Anemia
2. The measurement is also determined by how well the oxyhemoglobin and reduced-hemoglobin absorb the light of the specific wave-length being used. If there are other substances that can absorb light of the same wave-length, they can cause the measurement to be inaccurate or lower than the actual value of SpO₂. For example:
 - Carboxyhemoglobin
 - Methemoglobin
 - Methylene blue
 - Carmine indigo
3. Intense light in the environment can also influence measurement. Using a light-tight material to cover the sensor can improve the quality of the measurement.

[WARNING]

- Prolonged and continuous monitoring may increase the chances of unexpected changes in dermal condition, like abnormal sensitivity, rubescence, vesicle, repressive putrescence, and so on. It is especially important with neonate patients and patients of poor perfusion or immature dermogram to check the sensor placement by light collimation and by re-attaching the sensor depending on the condition of the skin. Check the sensor placement regularly and move it when the skin deteriorates. More frequent examinations may be required for different patients.
- DO NOT use SpO₂ sensors during magnetic resonance imaging (MRI). Induced current could potentially cause burns. The sensor may affect the MRI image, and the MRI unit may affect the accuracy of the oximetry measurements.

SPO2 ERROR MESSAGES

PLETH Waveform may display messages as below:

PROMPTS	EXPLANATION
Search Too Long	Search-time of SpO ₂ is too long
Searching For Pulse. . .	Searching for pulse signal
Sensor Off	Sensor has fallen off or the finger is not inserted in the finger-probe.
SpO ₂ Com Error	SpO ₂ board has communication error with the mainboard

MASIMO INFORMATION

TRADEMARK AND LICENSING LABELS



MASIMO PATENTS

Please refer to Masimo's website for detailed information.

Masimo Patents: [http:// www.masimo.com/patents.htm](http://www.masimo.com/patents.htm).

NO IMPLIED LICENSE

Possession or purchase of this device does not convey any express or implied license to use the device with unauthorized sensors cables which would, alone, or in combination with this device, fall within the scope of one or more of the patents relating to this device.

[WARNINGS]

- Pulse rate measurement is based on the optical detection of a peripheral flow pulse and therefore may not detect certain arrhythmias. So it should not be used as a replacement or substitute for ECG based arrhythmia analysis.
- OMNI II Patient Monitor should be considered an early warning device. As a trend towards patient deoxygenation is indicated, blood samples should be analyzed by a laboratory co-oximeter to completely understand the patient's condition.
- Interfering Substances: Carboxyhemoglobin may erroneously increase readings. The level of increase is approximately equal to the amount of carboxyhemoglobin present. Dyes or any substance containing dyes that change usual arterial pigmentation may cause erroneous readings.

MEASUREMENTS

If the accuracy of any measurement does not seem reasonable, first check the patient's vital signs by alternate means and then check the MS board for proper functioning.

Incorrect measurements may be caused by:

- Incorrect sensor application or use
- Significant levels of dysfunctional hemoglobins. (e.g., carboxyhemoglobin or methemoglobin)
- Intravascular dyes such as indocyanine green or methylene blue.
- Interfering Substances: Dyes, Nail polish or any substance containing dyes that change usual blood pigmentation may cause erroneous readings.

- Exposure to excessive illumination, such as surgical lamps (especially ones with a xenon light source), bilirubin lamps, fluorescent lights, infrared heating lamps, or direct sunlight (exposure to excessive illumination can be corrected by covering the sensor with a dark or opaque material)
- Excessive patient movement.
- SpO₂ is empirically calibrated to functional arterial oxygen saturation in healthy adult volunteers with normal levels of carboxyhemoglobin (COHb) and methemoglobin (MetHb). The monitor cannot measure elevated levels of COHb or MetHb. Increases in either COHb or MetHb will affect the accuracy of the SpO₂ measurement.
- Venous pulsations may cause erroneous low readings (e.g. tricuspid valve regurgitation).
- Patient suffers from abnormal pulse rhythm.
- Use only Masimo approved accessories.
- Motion artifact may lead to inaccurate measurements.
- Elevated levels of Total Bilirubin may lead to inaccurate SpO₂ measurements.
- With very low perfusion at the monitored site, the readings may read lower than core arterial oxygen saturation.
- Do not immerse the sensor or patient cable in water or, solvents, or cleaning solutions (The sensors and connectors are not waterproof).
- Placement of a sensor on an extremity with a blood pressure cuff, arterial catheter, or intravascular line.

Loss of pulse signal can occur in any of the following situation:

- The sensor is too tight.
- There is excessive illumination from light sources such as a surgical lamp, a bilirubin lamp, or sunlight.
- A blood pressure cuff is inflated on the same extremity as the one with a SpO₂ sensor attached.
- The patient has hypotension, severe vasoconstriction, severe anemia, or hypothermia.
- There is arterial occlusion proximal to the sensor.
- The patient is in cardiac arrest or is in shock.

SENSORS

- Use only Masimo oximetry sensors for SpO₂ measurements. Other oxygen transducers (sensors) may cause improper MS board performance.
- Tissue damage can be caused by incorrect application or use of an LNOP® / LNCS® sensor, for example by wrapping the sensor too tightly. Inspect the sensor site as directed in the sensor Directions for Use to ensure skin integrity and correct positioning and adhesion of the sensor.
- Do not use damaged LNOP® / LNCS® sensors. Do not use an LNOP® / LNCS® sensor with exposed optical components. Do not immerse the sensor in water, solvents, or cleaning solutions (the sensors and connectors are not waterproof). Do not sterilize by irradiation, steam, or ethylene oxide. See the cleaning instructions in the directions for use for reusable Masimo LNOP® / LNCS® sensors.

The OMNI II Patient Monitor with Masimo technology board is intended to be used with the following sensors:

For Human:

- Foam Wrap for M-LNCS Y1 Sensor
- M-LNCS® DCI: Adult Finger Sensor
- M-LNCS® DCIP: Pediatric Finger Sensor
- M-LNCS® YI: Multisite Reusable Sensor
- M-LNCS® Adtx Adhesive Sensors
- M-LNCS® pdtx Adhesive Sensors
- M-LNCS® Inf Adhesive Sensors
- M-LNCS® Neo Adhesive Sensors

- M-LNC-10: 10 ft. Patient Cable
- For Animal:
- M-LNCS® TC-I, Tip-Clip Reusable Sensor
 - M-LNCS® TF-I, Reusable Forehead Sensor
 - M-LNCS® YI, Multi-site Reusable Sensor
 - M-LNC-10

NELLCOR INFORMATION

TRADEMARK AND LICENSING LABELS



NELLCOR PATENTS

This device is covered under one or more the following U.S. Patents: 4,802,486; 4,869,254; 4,928,692; 4,934,372; 5,078,136; 5,351,685; 5,485,847; 5,533,507; 5,577,500; 5,803,910; 5,853,364; 5,865,736; 6,083,172; 6,463,310; 6,591,123; 6,708,049; Re.35,122 and international equivalents U.S.A international patents pending.

NO IMPLIED LICENSE

Possession or purchase of this device does not convey any express or implied license to use the device with unauthorized replacement parts which would, alone, or in combination with this device, fall within the scope of one or more of the patents relating to this device.

MAINTENANCE AND CLEANING

After every time of use, the cable must be cleaned and following the methods below:

- Use alcohol detergent solution (e.g. 70% isopropyl alcohol) to clean the cable. Do NOT sterilize by irradiation, steam, or ethylene oxide. Do NOT use any metal grinding medium for cleaning.
- To clean the probe, hold the tip with one hand, the other hand rubbing the probe down in the direction of the connector using a moist lint-free cloth. Do NOT immerse the sensor in water, solvents, or cleaning solutions

NIBP MONITORING

- NIBP MONITORING PRINCIPLE
- NIBP CUFF FITTING
- NIBP MONITORING INITIALIZATION
- NIBP SETUP
- NIBP LIST OBSERVATION
- MEASUREMENT LIMITATIONS
- NIBP ERROR MESSAGES
- MAINTAINENCE AND CLEANING

NIBP MONITORING PRINCIPLE

The Non-invasive Blood Pressure (NIBP) module measures the blood pressure using the oscillometric method.

It can be used on **adult**, **pediatric** and **neonatal** patients.

There are three modes of measurement available: **Manual**, **Automatic** and **Stat**. Each mode displays the diastolic, systolic and mean blood pressure.

[WARNING]

- You must not perform NIBP measurements on patients with sickle-cell disease or any condition under which the skin is damaged or expected to be damaged.
- For a thrombasthenia patient, it is important to determine whether measurement of the blood pressure will be done automatically. This decision should be based on the clinical evaluation.
- Before starting a measurement, verify that you have selected a setting appropriate for your patient (adult, pediatric or neonate). Ensure that the correct setting is selected when performing measurements on neonate patients, because the higher adult BP level is not suitable for neonate patients, and it may be dangerous for the neonate patient to be exposed to high pressure level.
- DO NOT apply the cuff to a limb that has an intravenous infusion or catheter in place. This could cause tissue damage around the catheter when infusion is slowed or blocked during cuff inflation.

NIBP CUFF FITTING

1. How well the blood pressure cuff fits the patient will influence the accuracy of the NIBP measurement. The cuff width recommend by the **AMERICA HEART SOCIETY** is 40% of upper arm circumference or 2/3 of the upper arm length.
2. Apply the blood pressure cuff to the patient's arm:
 - Make sure that the cuff is completely deflated.
 - Apply the appropriate size cuff to the patient, and make sure that the symbol "φ" is over the appropriate artery. Ensure that the cuff is not wrapped too tightly around the limb. Excessive tightness may cause discoloration and eventual isocheimal of the extremities.
3. Make sure that the cuff has not been twisted.
4. Insert the air hose into the **NIBP** socket on the left panel of monitor. Ensure that the spring block on the left side of socket has been pressed.

[WARNING]

- The width of the cuff should be either 40% of the limb circumference (50% for neonates) or 2/3 of the upper arm length. The inflatable part of the cuff should be long enough to encircle 50-80% of the limb. Using the wrong cuff size can cause erroneous readings. If you are unsure about which cuff size to use, use a larger cuff.
- Make sure that the cuff edge falls within the range of <->. If does not, then change to a more suitable cuff.
- Connect the cuff to the air hose. The limb chosen for taking the measurement should be placed at the same level as the patient's heart. If this is not possible you should apply the following corrections to the measured values:
- If the cuff is placed higher than the heart level, add 0.9mmHg (0.12kPa) for each inch of difference.
- If it is placed lower than the heart level, deduct 0.9mmHg (0.12kPa) for each inch of difference.

NIBP MONITORING INITIALIZATION

After opening the host machine, check the information area of the screen before NIBP monitoring. If you see NIBP MODULE SELF-CHECK OK, then the NIBP module is working, and you can begin NIBP monitoring (any NIBP monitoring taken before the SELF-CHECK OK indicator is shown is invalid). If you see NIBP MODULE SELF-CHECK ERROR, then the NIBP is not working. Press the **START/STOP** button to run the self-check or machine-open again. If the error persists,, contact a servicing engineer.

NIBP SETUP

Touch the NIBP Parameter Area to open the NIBP Setup menu.

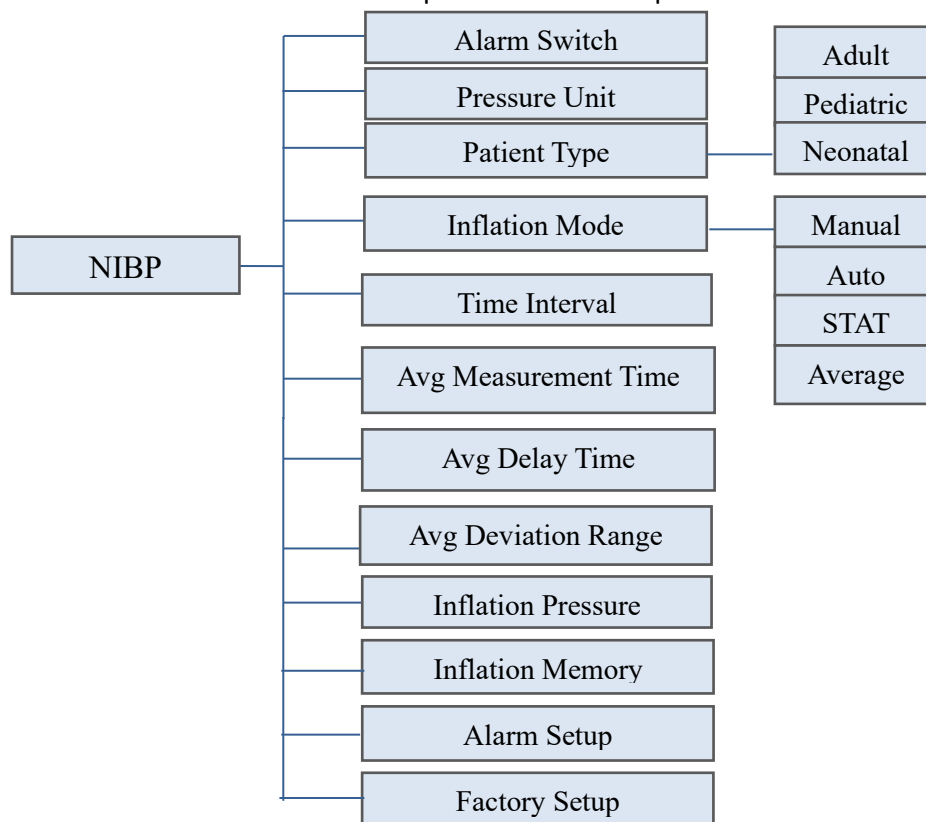



Figure 19: Tree Diagram for NIBP Setup Menu

This menu has the following settings:

ALARM SWITCH

ON and **OFF** for choice, the factory setting is ON.

If the NIBP value is above or below the NIBP alarm limit, and the settings are set to ON, then the alarm will be activated. When the settings are set to **OFF**, the alarm indicator will not light up, the corresponding alarm parameter will not flash and the corresponding parameter will display the  icon.

PRESSURE UNIT

mmHg or **kPa**, the factory setting is **mmHg**.

PATIENT TYPE

ADULT TYPE

This setting applies to the **adult** mode. Inflate the cuff to 180 mmHg (24 kPa). If the NIBP value cannot be measured, then inflate the cuff for the second time, but note that the maximum pressure cannot exceed 297 mmHg (40 kPa). The factory setting is ADULT TYPE.

PEDIATRIC TYPE

This setting applies to the **pediatric** mode. Inflate the cuff to 170 mmHg (23 kPa). If the NIBP value cannot be measured, then inflate the cuff for the second time, but note that the maximum pressure cannot exceed 297 mmHg (40 kPa).

NEONATAL TYPE

This setting applies to the **NEONATAL** mode. Inflate the cuff to 100 mmHg (13 kPa). If the NIBP value cannot be measured, then inflate the cuff for the second time, but note that the maximum value cannot exceed 147 mmHg (20 kPa).

If this setup is done before the NIBP module is initiated, the settings will not be effective.

The inflation ranges shown above has been implemented on NIBP, which uses them to guarantee the safety of the patient.

INFLATION TYPE

There are three choices: Manual, Auto, STAT and Average.

MANUAL MODE

Press the **START/STOP** button to begin inflation. The information area of the display should read "Manual measuring... ", This shows that measurement is being taken. Once the NIBP measurement is finished, NIBP parameter area will display the values and the information area will read "Manual measuring end!", and the measurement process will have finished.

If the NIBP value cannot be measured, the NIBP parameter area will display any error messages and automatically attempt to take the measurement again up to three times.

If the value still cannot be measured, the information area will read "RETRY OVER! ", and no more measurements will be taken.

During the measurement, press the **START/STOP** button again to stop the NIBP measurement process. The information area will read "Stop manual measuring".

AUTOMATICAL MODE

NIBP parameter area will display the countdown of "Auto measuring..." (Time Interval). Under this setting, the machine will continue re-measure NIBP at every time interval until the mode is changed.

If you start a measurement manually, the monitor will then continue automatically repeat

NIBP measurements at the set time interval.

If the NIBP measurement is finished, the NIBP parameter area will display the values and the information area will give a note of "Auto measuring end". The monitor will then continue automatically measuring until the mode is changed.

If the NIBP value cannot be measured, the NIBP parameter area will display some error messages and will attempt to take the measurement again up to three times. If the value still cannot be measured, the information area will read "RETRY OVER!" And automatically continue to take measurements at every time interval until the mode is changed.

If the **START/STOP** button is pressed during any point in the countdown period, the monitor will immediately begin a new measurement.

During the measurement, pressing the **START/STOP** button again will stop the current NIBP measurement, and the information area will read "Stop auto measuring", but the monitor will continue to automatically take measurements at every time interval.

[WARNING]

Prolonged non-invasive blood pressure measurements in Auto mode may be associated with purport, isocheimal and neuropathy in the limb wearing the cuff. When monitoring a patient, examine the extremities of the limb frequently for normal color, warmth and sensitivity. If any abnormality is observed, stop the blood pressure measurements.

STAT MODE

In the stat mode, the monitor will measure NIBP three times without stopping and then will stop automatically. You can also press the **START/STOP** button to end the measurement manually.

Press the **START/STOP** button to begin inflation. The information area will display "STAT measuring..." to indicate that the measurement is being taken. Once the NIBP measurement has finished, the NIBP parameter area will display the values and the information area will read "STAT measuring end".

If the NIBP value cannot be measured, the NIBP parameter area will display some error messages and automatically will attempt to take the measurement again up to three times. If the value still cannot be measured, the information area will read "RETRY OVER!", and the monitor will then do one more measurement that lasts 5 minutes and stop.

During the measurement, if you press the **START/STOP** button again, the information area will read "STOP STAT TEST", and the monitor will stop the NIBP measurement and exit from this mode.

AVERAGE MODE

In the average mode, it will measure NIBP for multiple times before displaying a calculated average result. You can press the button of **START/STOP** to end the measurement manually.

[NOTE]

The measured value will be display on the NIBP parameter area for 240 minutes unless a new measurement is taken during this period. On the appropriate trend graph and trend table, the parameter will be included for the appropriate length of time.

TIME INTERVAL

This setting is available with Auto inflation mode and average inflation mode. This is the time interval between two automatic measurements. You can input the time interval as you need. The range is 1 min to 4 hours.

AVG MEASUREMENT TIME

This setting is available with **Average** inflation mode. This is the measurement times of which the monitor will calculate the average. The result will be only displayed after all measurements are finished and the average reading is calculated. You can input the measurement time as you need, the range is 3 times to 99 times

AVG DELAY TIME

This setting is available with **Average** inflation mode. This is the delay time before a new set of measurements starts. You can input the delay time as you need, the range is 1min to 4 hours.

AVG DEVIATION RANGE

This setting is available with **Average** inflation mode. This is the deviation range for registering the valid measurement within an Average Measuring cycle. If the second measurement is out of the deviation range compared to the first measurement, this second measurement will not be registered for calculating the average result, monitor will retake the second measurement. You can input the range as you need, the range is 5% to 30 %

INFLATION MEMORY

When chose "ON", the monitor memorizes the latest blood pressure reading for same patient type or same patient ID, then the next measurement will begin with a Inflation Pressure same as the memorized blood pressure, if the patient type or patient ID is changed, the next measurement will begin with the setting Inflation Pressure. When chose "Off", the Inflation Pressure will begin with the one had been set.

INFLATION PRESSURE

This is to set the initial inflation pressure. When INFLATION MEMORY is "off", the inflation pressure for a new measurement will always begin with the setting inflation pressure.

Inflation Pressure option is as below:

Adult	Pediatric	Neonatal	Large Vet (Infinium)	Small Vet (Infinium)	Large/small Vet (SunTech)
160mmHg	140mmHg	100mmHg	150mmHg	100mmHg	160mmHg
180mmHg					
220mmHg					

ALARM LIMIT SETUP

<i>Limits</i> <i>Patient Type</i>	SYS UPPER LIMIT(mmHg)	SYS LOWER LIMIT(mmHg)	DIA UPPER LIMIT(mmHg)	DIA LOWER LIMIT(mmHg)
Adult	30~270 Factory setting:150	30~270 Factory setting:100	10~215 Factory setting:90	10~215 Factory setting:50
Neonatal	30~240 Factory setting:90	30~240 Factory setting:40	10~180 Factory setting:60	10~180 Factory setting:20
Pediatric	30~270 Factory setting:120	30~270 Factory setting:70	10~215 Factory setting:70	10~215 Factory setting:40

The alarm limit must be changed in increments of at least **5** mmHg.

FACTORY SETUP

This function is for servicing engineers only.

NIBP LIST OBSERVATION

Touch the NIBP List Area to open the NIBP List Table. Touch again will put away the NIBP List.

NO.	Time	NIBP List	HR
1	10:22	120/80	110
2	10:22	120/80	100
3	10:21	120/80	60
4	10:21	120/80	80
5	10:21	120/80	120
6	10:20	120/80	80

PageDown PageUp Print

Figure 20: Window for NIBP List Observation

[NOTE]: Only after the NIBP value has been measured can it be added to the NIBP Data List. NIBP list can save up to 256 groups of data. If exceed, the new data will remove the oldest data from the list and be added to the list.

MEASUREMENT LIMITATIONS

For certain patient conditions, the oscillometric measurement has certain limitations. The measurement must find regular arterial pressure. When the patient's condition makes it difficult to detect this pressure, the measurement will be unreliable and take longer to complete. In some cases, the patient's condition will make a measurement impossible. Such issues may arise under the following circumstances:

PATIENT MOVEMENT

Measurements will be unreliable or impossible to take if the patient is moving, shivering or having convulsions. These motions may interfere with the detection of the pulses in arterial pressure and increase the time needed to take the measurement.

CARDIAC ARRHYTHMIA'S

Measurements will be unreliable or impossible to take if the patient's cardiac arrhythmia has caused an irregular heartbeat. It will also take longer to take the measurement.

HEART-LUNG MACHINE

It will not be possible to take measurements if the patient is connected to a heart-lung machine.

PRESSURE CHANGES

Measurements will be unreliable or impossible to take if the patient's blood pressure is changing rapidly while the measurement is being taken.

SEVERE SHOCK

If the patient is in severe shock or hypothermia, measurements will be unreliable since reduced blood flow to the peripheries will cause reduced pulsation of the arteries.

HEART RATE EXTREMES

Measurements cannot be made if the patient's heart rate is less than 40 bpm or greater than 240 bpm.

NIBP ERROR MESSAGES

Message area may display messages like the following:

Patient moving!	Serial error
Pressure < 10 mmHg!	NIBP renew self-check...
Pressure < 1.3 kPa!	NIBP self-check...
Pressure > 325 mmHg!	NIBP self-check error!
Pressure > 43.3 kPa!	NIBP inter error!
Serial overtime!	Patient type error!
Reset error!	Setup patient...
Zero reset error!	NIBP self-check ok!

MAINTAINENCE AND CLEANING

[NOTE]

DO NOT squeeze the rubber tube on the cuff.

REUSABLE BLOOD PRESSURE CUFF

The cuff can be sterilized with conventional autoclaving, gas or radiation sterilization in hot air ovens, or by being submerged in decontamination solutions. If you use this last method, remember to remove the rubber bag. The cuff should not be dry-cleaned. The cuff can be machine-washed or hand-washed; hand washing may prolong the service life of the cuff. Before washing, remove the latex rubber bag, and for machine-washing, close the Velcro fastening. Allow the cuff to dry thoroughly after washing, and then reinsert the rubber bag.

Replace the bladder after cleaning and disinfecting the cuff, the method is as follows:

1. Place the bladder on the top of the cuff, as the figure shows.
2. Roll the bladder lengthwise and insert it into the large opening.
3. Hold the hose and the cuff and shake the complete cuff until the bladder is in position.
4. Thread the hose from inside the cuff, and out through the small hole under the internal flap.

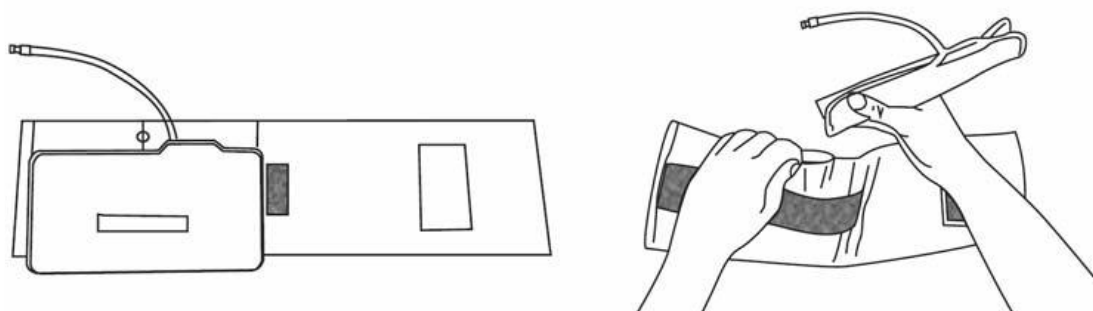

Figure 21: Sketch Map for Replacing the Bladder

TEMP MONITORING

- THEORY OF OPERATION
- TEMP SENSOR INSTALLATION
- TEMP SETUP
- TEMP ERROR MESSAGES
- MAINTAINENCE AND CLEANING

THEORY OF OPERATION

The monitor provides one or two isolated temperature measurement channels (T1 and T2). If the second temperature channel is installed, the temperature difference between the two channels is an available option. Temperature difference is displayed as “ ΔT ” or delta temperature.

The monitor utilizes a temperature probe with a thermistor to give continuous electronic temperature readings of either core body temperature via rectal/esophageal probe or skin temperature via an external sensor.

TEMP SENSOR INSTALLATION

1. Insert the plug of the **T1 and/or T2** sensors into the sensor socket on the left panel of monitor.
2. Put the probe on the patient according to probe instructions (lacuna and body).

[WARNING]

Inspect the probe for wear or tear after every disinfection/sterilization process is complete. If wear or tear of the probe is found upon visual inspection, a new probe should be used.

TEMP SETUP

Touch the Temp parameter area to open the menu of TEMP Setup menu, which is laid out as below:

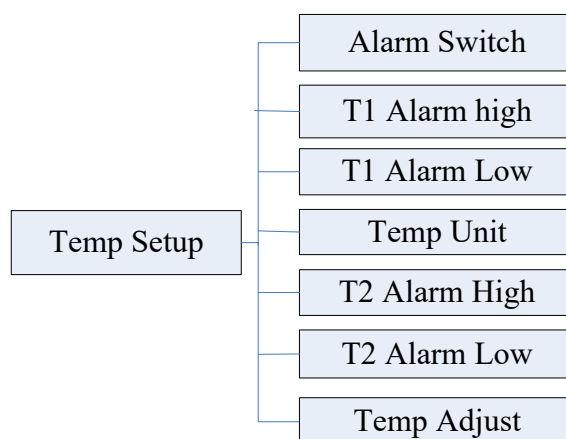



Figure 22: Tree Diagram for Temp Setup Menu

The menu has the following settings:

ALARM SWITCH

ON or OFF can be chosen. The factory setting is **ON**.

If the TEMP value is above or below the TEMP alarm limit, and the alarm is **ON**, then the alarm will be activated. When the alarm is **OFF**, the alarm indicator will not light up, the corresponding alarm parameter will not flash and corresponding parameter area will display the  icon.

TEMP UNIT

Fahrenheit or Celsius can be chosen. The factory setting is Celsius.

TEMP ALARM UPPER-LIMIT

The T1 or T2 alarm upper-limit range is **10°C~50°C (50°F~122°F)**, and the factory setting is **38.0°C (100.4°F)**. The temperature can be adjusted in increments of **0.1°C (0.2°F)**.

TEMP ALARM LOWER-LIMIT

The T1 or T2 alarm lower-limit range is **10°C~50°C (50°F~122 °F)**, and the factory setting is **36°C (96.8°F)**. The temperature can be adjusted in increments of **0.1°C (0.2°F)**.

TEMP ADJUST

Servicing engineers use only.

TEMP ERROR MESSAGES

TEMP SENSOR OFF: the TEMP probe has fallen off of the monitor.

MAINTAINENCE AND CLEANING

REUSABLE TEMP PROBES

1. The TEMP probe should not be heated above 100°C (212°F). It should only be subjected briefly to temperatures between 80°C (176°F) and 100°C (212°F).
2. The probe must not be sterilized in steam.
3. Clean the probe with alcohol detergent solution.
4. To clean the probe, hold the tip with one hand and use your other hand to rub down the probe in the direction of the connector using a moist lint-free cloth.

ETCO2 MONITORING (OPTIONAL)

- THEORY OF OPERATION
- WARNINGS
- ABBREVIATIONS AND TERMINOLOGY
- ZEROING THE CO₂ MODULE
- PATIENT AND TUBING PREPARATION
- ETCO₂ SETUP
- ADVANCED SETUP
- CALIBRATION
- STATUS/ERROR MESSAGES
- MAINTENANCE AND CLEANING

THEORY OF OPERATION

Carbon dioxide monitoring is used to monitor continuous carbon dioxide and report the End Tidal carbon dioxide (EtCO₂), inspired CO₂ and respiratory rate values of the intubated and non-intubated adult, pediatric, infant and neonatal patient.

In carbon dioxide monitoring system, infrared light is generated by the sensor and beamed through the sample cell to a detector on the opposite side. CO₂ from the patient that is aspirated into the sample cell absorbs some of this infrared energy. The monitor determines CO₂ concentration in the breathing gases by measuring the amount of light absorbed by these gases. EtCO₂ is displayed as a numerical value in millimeters of mercury (mmHg), percent (%), or kilopascals (kPa). In addition, a CO₂ waveform (capnogram) may be displayed which is a valuable clinical tool that can be used to assess patient airway integrity and proper endotracheal tube (ETT) placement. Respiration rate is calculated by measuring the time interval between detected breaths.

There are two methods for measuring CO₂ in the patient's airway:

1. Mainstream measurement uses a CO₂ sensor attached to an airway adapter directly inserted into the patient's breathing system.
2. Sidestream/Microstream measurement samples expired patient gas at a constant sample flow from the patient's airway and analyzes it with a CO₂ sensor built into the CO₂ module.

WARNINGS

- ◆ DO NOT position the sensor cables or tubing in any manner that may cause entanglement or strangulation. Support the carbon dioxide monitoring system airway adapter to prevent stress on the ET tube.
- ◆ Reuse, disassembly, cleaning, disinfecting or sterilizing the single patient use cannula kits and on-airway adapters may compromise functionality and system performance leading to a user or patient hazard. Performance is not guaranteed if an item labeled as single patient use is reused.
- ◆ Inspect the sidestream on-airway adapters and sidestream sampling kits for damage prior to use. DO NOT use the sidestream on-airway adapters and sidestream sampling kits if they appear to be damaged or broken.
- ◆ Replace the sidestream on-airway adapters and sidestream sampling kits if excessive secretions are observed.
- ◆ Monitor the CO₂ check waveform (Capnogram). If you see changes or abnormal appearance the patient and the sampling line. Replace line if needed.
- ◆ DO NOT apply excessive tension to any cable.
- ◆ DO NOT use device on patients that can not tolerate the withdrawal of 50 ml/min +/- 10 ml/min from the airway or patients that can not tolerate the added dead space to the airway.
- ◆ DO NOT connect the exhaust tube to the ventilator circuit.
- ◆ DO NOT stick appendage into sample receptacle.
- ◆ Always insert sample cell before inserting the on-airway adapter into the ventilated

circuit.

- ◆ Always remove the on-airway adapter from the ventilated circuit before removing the sample cell.
- ◆ Nitrous oxide, elevated levels of oxygen, helium, Xenon, halogenated hydrocarbons, and barometric pressure can influence the CO₂ measurement.

ABBREVIATIONS AND TERMINOLOGY

EtCO ₂	End tidal carbon dioxide
INSP CO ₂	Inspired minimum CO ₂
AWRR	Air-way respiration rate
BARO	Barometric Pressure

ZEROING THE CO₂ MODULE

The sample cell zero allows the CO₂ Module to adjust to the optical characteristics of the sample cell only when requested.

For optimal accuracy, a CO₂ Module zero should be performed whenever the CO₂ Module is connected to the Patient Monitor.

Before performing a CO₂ Module zero, the CO₂ Module should be removed from the Patient Monitor and the airway adapter type to be used in the circuit should be inserted into the CO₂ Module. Care should be taken ensure that the airway adapter is clear of any residual CO₂ gas. The maximum elapsed time for a CO₂ Module zero is 30 seconds. The typical time for a zero is 15 – 20 seconds.

Several CO₂ Module conditions may also request that a zero be performed. These requests stem from changes in the airway adapter that may indicate that the sensor is not in optimal measuring condition. When this occurs, the airway adapter should be checked to ensure optical occlusions such as mucus have not obscured the adapter window. If occlusions are found, the airway adapter should be cleaned or replaced.

NOTE:

- ◆ System does not allow adapter zero for 20 seconds after the last breath is detected.
- ◆ System does not allow adapter zero if temperature is not stable.
- ◆ An adapter zero cannot be performed if a sample cell is not connected to the module.

PATIENT AND TUBING PREPARATION

1. MODULE MOUNTING

- Put the CO₂ module into the bracket of the rear panel of the monitor.
- Check that monitor is switched off, Insert the plug of CO₂ sensor into the corresponding sensor socket marked with **EtCO₂** icon on the left panel of monitor.

[WARNING]: Don't hot plug EtCO₂ module, that is make sure that the OMNI II is powered off before Insert the connector of CO₂ sensor into EtCO₂ socket. Otherwise the CO₂ module may be damaged by power supply from EtCO₂ socket of OMNI II.

2. CONNECTING THE SAMPLE KIT

- The sample cell of the sampling kit must be inserted into the sample cell receptacle of the CO₂ Module as shown in following figure. A "click" will be heard when the sample cell is properly inserted.

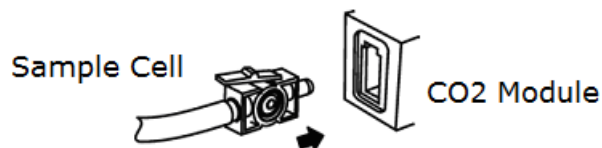

- b. Connect the CO₂ tubing to Nasal and Nasal/Oral Sidestream Kits.
- c. Inserting the sample cell into the receptacle automatically starts the sampling pump. Removal of the sample cell turns the sample pump off.
- d. To remove the sampling kit sample cell from the sample cell receptacle, press down on the locking tab and pull the sample cell from the sample cell receptacle.

DIRECTIONS

For use of single patient use nasal and nasal/oral sidestream kits

CAUTION: The Nasal and Nasal/Oral Cannula kits are intended for single patient use. Do NOT reuse or sterilize the cannula kit as system performance will be compromised.

1. Verify that the cannula kit is clean, dry and undamaged. Replace the cannula kit if necessary.
2. Insert the sample cell into the sample cell receptacle as shown in above figure on connecting the Sample Kit section. A “click” will be heard when properly inserted.
3. Perform a sample cell zero if prompted by the host system.
4. Place the nasal cannula kits onto the patient as shown in following figure.

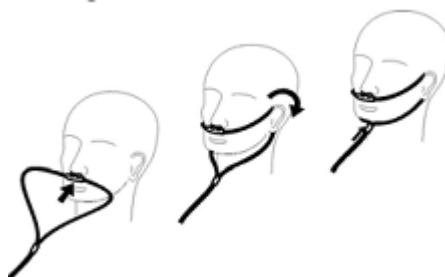

5. Some patients are prone to mouth breathing. The Oral/Nasal sampling cannula should be used on these patients, as most, if not all of the CO₂ is exhaled through the mouth. If a standard nasal CO₂ sampling cannula is used with these patients, the EtCO₂ number and capnogram will be substantially lower than actual.
6. When using the Nasal or Oral/Nasal CO₂ sampling kits with oxygen delivery, place the cannula on the patient and then attach the oxygen supply tubing to the oxygen delivery system and set the prescribed oxygen flow.
7. If the oral/nasal cannula is used, the oral sampling tip may need to be trimmed to adequately fit the patient (see following figure). Place the cannula onto the patient as shown in above picture. Observe the length of the oral cannula tip. It should extend down past the teeth and be positioned in the mouth opening. Remove the cannula from the patient if the tip needs to be trimmed.



CAUTION: DO NOT cut the oral cannula tip when the cannula is on the patient.

CAUTION: Remove the sampling kit sample cell from the CO₂ Module Inlet Port when not been use.

ETCO2 SETUP

Touch the EtCO₂ Waveform or Parameter Area to open the menu for EtCO₂ Setup, which is laid out as follows:

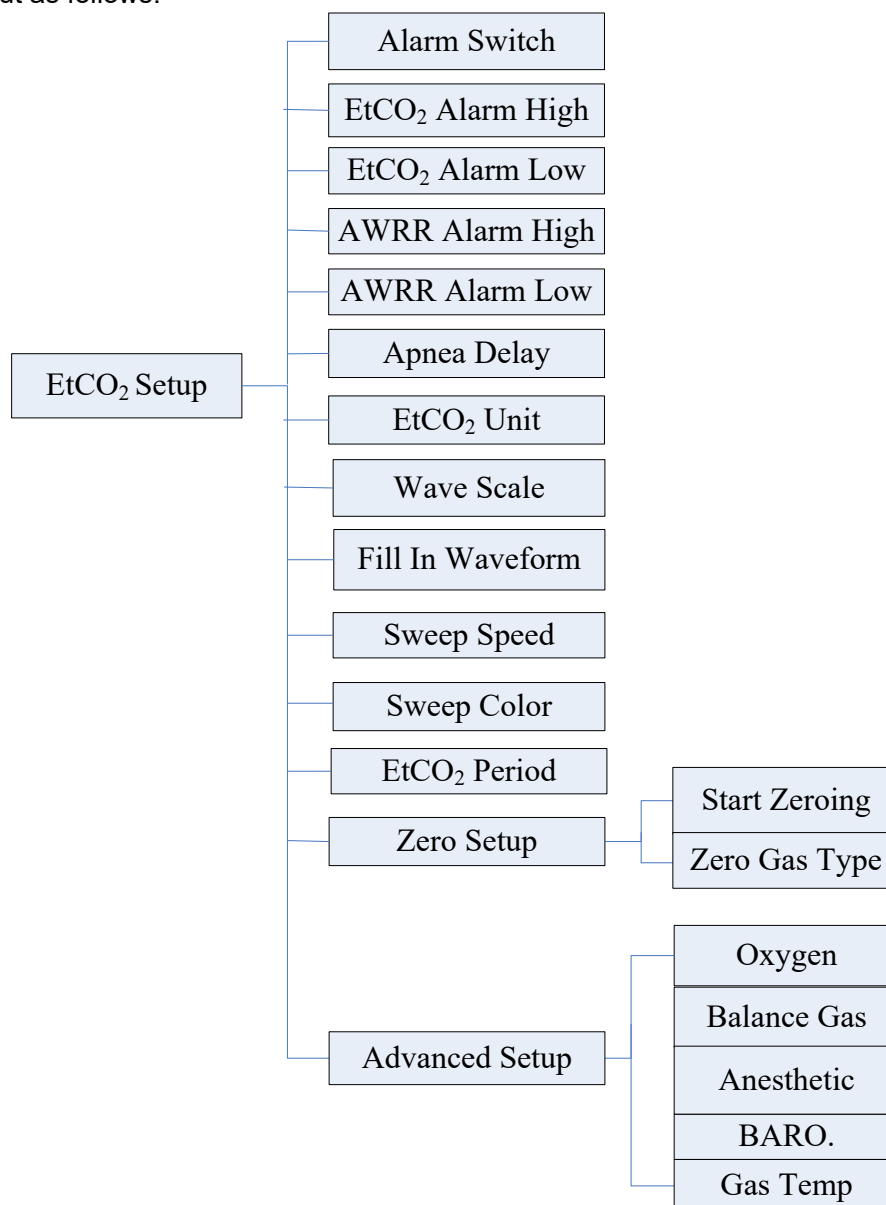



Figure 23: Tree Diagram for EtCO₂ Setup Menu

ALARM SWITCH

Can be ON or OFF, and the factory setting is **ON**. When the alarm is ON, the alarm is activated. When the alarm is **OFF**, the alarm indicator will not light up, the corresponding alarm parameter will not flash and corresponding parameter area will display the  icon.

ETCO2 ALARM HIGH

The range is 20~100 mmHg, and the factory setting is 60 mmHg.

ETCO2 ALARM LOW

The range is 10~95 mmHg, and the factory setting is 15 mmHg.

AWRR ALARM HIGH

The range is 10~150 rpm. The default alarm limit depends on the patient type. When the patient type is adult or pediatric, the factory setting is **30** rpm; when it is neonatal, the factory setting is **100** rpm.

AWRR ALARM LOW

The range is 5~100 rpm. The default alarm limit depends on the patient type. When the patient type is adult or pediatric, the factory setting is **5** rpm; when it is neonatal, the factory setting is **30** rpm.

The alarm limit can be adjusted in increments of 5 rpm.

ASPHYXIA DELAY

This setting is used to set the no breaths detected time-out. This time-out is the elapsed time in seconds following the last detected breath at which the CO₂ module will signal that no breaths have been detected. The monitor will alarm if the patient has stopped breathing for longer than the preset apnea time.

The setting range is 10~60 seconds, and the factory setting is 10 seconds.

ETCO₂ UNIT

Choose from mmHg, kPa or percent (%). The factory setting is mmHg.

WAVEFORM SCALE

Use this setting to adjust the amplitude (size) of the displayed EtCO₂ waveform scale manually.

There are two items options: 0~75 mmHg and 0~150 mmHg.

FILL IN WAVEFORM

Use this setting to fill in the bottom portion of the waveform on any channel of the display; the "fill in" can be canceled by choosing NO.

SWEEP SPEED

Options are 12.5mm/s and 25mm/s, and the factory setting is 12.5mm/s.

SWEEP COLOR

Options are White, Gray, Red, Yellow, Green, Cyan, Blue, and Magenta, and the default-set is Cyan.

ETCO₂ PERIOD

This setting is used to set the calculation period of the EtCO₂ value. The end-tidal CO₂ value is the highest peak CO₂ value of all ends of expirations (end of breaths) over the selected time period. If fewer than two breaths exist in the selected time period, the value will be the maximum EtCO₂ value for the last two breathes.

The options for this setting are 1 breath, 10 seconds and 20 seconds, and the factory setting is 1 breath.

ZERO SETUP

For detailed steps on zeroing, please refer to the "Zeroing the CO₂ Module" section.

Complete the zeroing procedure by pressing "**Start Zeroing**" item. During zeroing, a message of "EtCO₂ Zero Started" will be displayed in the message area.

[NOTE]: During the CO₂ module warmup period after the monitor is powered on, the monitor will perform an automatic zero calibration. The maximum elapsed time for a CO₂ Module zero is 30 seconds. The typical time for a zero is 15 – 20 seconds.

ZERO GAS TYPE

When performing a zero on room air, this setting should be set to room air (the default).

Only change to nitrogen (N₂) when performing a zero on 100% N₂ gas. This is provided for use in a laboratory environment.

ADVANCED SETUP

Select “**ADVANCED SETUP**” item to call up the related menu:

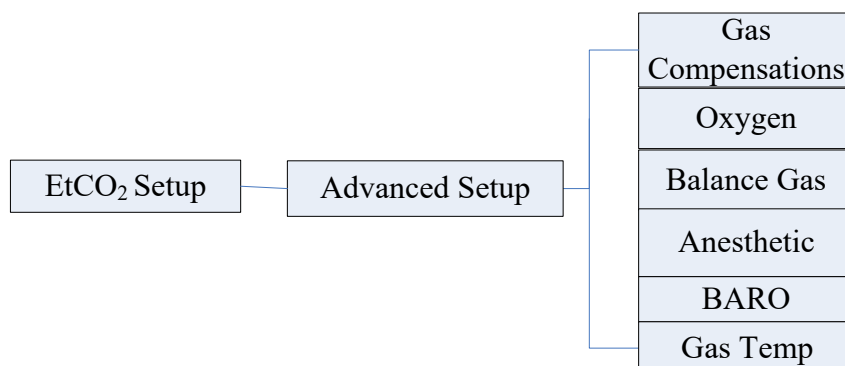

Figure 24: Tree Diagram for EtCO₂ Advanced Setup

SET GAS COMPENSATIONS

The measurement of CO₂ is affected by temperature, pressure, and gas compensations. The barometric pressure as well as the presence of O₂, N₂O, helium, and anesthetic agents in the gas mixture needs to be compensated for by the CO₂ module in order to achieve its stated accuracy. The instrument settings for these parameters should be set when initially connecting to the CO₂ module and whenever there is a change in the conditions of the patient's airway.

In the CO₂ module, the temperature of the gas in the airway also effects the CO₂ measurement. It is necessary to adjust the instrument setting for the gas temperature to achieve the maximum accuracy for the CO₂ module.

OXYGEN COMPENSATION

The setting range is 0~100 %. The factory setting is 16 %.

BALANCE GAS

The options are room air, N₂O and Helium.

ANESTHETIC AGENT

Use this setting to compensate for the gas mixture administered to the patient. The anesthetic agent is ignored when the balance gas is set to helium.

The setting range is 0.0~20.0 %. The factory setting is 0.0 %.

[NOTE]

At 700mmHg of pressure, the correct CO₂ value is 35.0 mmHg.

BAROMETRIC PRESSURE

This setting is used to set the current barometric pressure.

The setting range is 400~850 mmHg. The factory setting is 760 mmHg.

GAS TEMPERATURE

This setting is used to set the temperature of the gas mixture. This setting is useful when bench testing using static gasses where the temperature is often room temperature or below.

The setting range is 0~50°C. The factory setting is 35°C.

CALIBRATION

No routine user calibration required.

Safety lockouts:

- ♦ System does not allow sample cell zero for 20 seconds after the last breath is detected.
- ♦ System does not allow sample cell zero if temperature is not stable.
- ♦ An adapter zero cannot be performed if a sample cell is not connected to the module.

STATUS/ERROR MESSAGES

Messages	Descriptions
Sensor Off	The CO ₂ sensor is not connected.
Sensor Warm Up	One of the following conditions exists: Sensor under temperature Temperature not stable Source Current unstable
Sensor Over Temp	Make sure sensor is not exposed to extreme heat (heat lamp, etc.). If error persists, return sensor to factory for servicing.
Sensor error	Check that the sensor is properly plugged in. Reinsert or reset the sensor if necessary. If error persists, return sensor to factory for servicing.
Sensor Zeroing. . .	A zero is currently in progress.
Zero Required	To clear, check airway adapter and clean if necessary. If this does not correct the error, perform an adapter zero. If you must perform an adapter zero more than once, a hardware error may exist.
Check Sampling Line	To clear, clean if sampling line mucus or moisture is seen. If the sampling line is clean, perform a zero.
CO ₂ Out of Range	The value being calculated is greater than the upper CO ₂ limit (150 mmHg, 20.0 kPa, or 19.7 %). The maximum value output is the upper CO ₂ limit.
Check Airway Adapter	To clear, clean airway adapter if mucus or moisture is seen. If the adapter is clean, perform a zero.
Pump Life Exceed	The manufacturer stated pump life has been exceeded. Service may be required if Pneumatic System Error is present and the error message can no longer be cleared.
Sensor Setup. . .	The CO ₂ sensor is setting up.
EtCO ₂ Zero Error: Sensor Not Ready.	The CO ₂ sensor is not ready for a EtCO ₂ Zero.
EtCO ₂ Zero Error: Breath Detected.	Breathing has have been detected by the CO ₂ module within the last 20 seconds while a CO ₂ module zero was attempted.

MAINTENANCE AND CLEANING

SCHEDULE

The CO₂ Module flow rate accuracy should be verified by direct measurement using a calibrated flow meter every 12 months.

CLEANING

Cleaning the CO₂ Module case, cable and connector:

1. Use a cloth dampened with isopropyl alcohol 70%, a 10% aqueous solution of sodium hypochlorite (bleach), a 2% glutaraldehyde solution, ammonia, mild soap or disinfectant spray cleaner such as Steris Coverage® Spray HB.
2. Wipe down with a clean water-dampened cloth to rinse and dry before use. Make certain that the sensor windows are clean and dry before reuse.

[NOTE]

DO NOT submerge or sterilize the CO₂ Module.

Cleaning the Sidestream On-Airway Adapters and Sidestream Sampling Kits:

Sidestream on-airway adapters and sidestream sampling kits are for single patient use. Treat in accordance with hospital protocols for handling single patient use devices.

IBP MONITORING (OPTIONAL)

- THEORY OF OPERATION
- INTRODUCTION
- WARNING
- PREPARATION FOR MONITORING
- INSTRUCTIONS FOR USE OF TRANSDUCER MONITORING KIT
- IBP SETUP
- SET TRANSDUCER ZERO
- PROMPT MESSAGE
- MAINTAINENCE AND CLEANING

THEORY OF OPERATION

There are two ways of measuring blood pressure: Direct (Invasive Pressure or IP) and Indirect (Non-invasive Blood Pressure or NIBP) method. The indirect method uses simple equipment but provides limited physiological information. The direct or invasive method (IP) provides accurate pressure measurements in regions of the cardiovascular system that are inaccessible to the indirect method.

To measure blood pressure by the invasive method, a catheter is inserted in a blood vessel and taken to the point of interest. The catheter has a transducer that provides electrical signals, which are then processed and analyzed by the monitor. Measurement of blood pressure by the invasive method gives the values of the systolic (maximum), diastolic (minimum) and mean pressure.

The invasive pressure range is from -30 to 300 mmHg, allowing the operator to use the monitor for measuring arterial pressure, pulmonary artery pressure and central venous pressure.

INTRODUCTION

When an invasive pressure is selected to be displayed on a waveform channel, the monitor will default to the label IBP1 or IBP2, which indicates general "Invasive Pressure". In addition, the monitor allows the selection of a pressure channel label that more clearly identifies a measurement. The choices for invasive arterial pressures are:

ART	Arterial Blood Pressure
PA	Pulmonary Artery Pressure
CVP	Central Venous Pressure
RAP	Right Arterial Pressure
LAP	Left Arterial Pressure
ICP	Intracranial Pressure

WARNING

- ◆ For invasive pressure monitoring, routinely inspect the catheter and/or pressure line for leaks after zeroing. Always follow the pressure transducer/catheter manufacturer's use recommendations.
- ◆ Always zero the pressure transducer(s) prior to patient use.
- ◆ Non-physiological pulsatile invasive pressure waveforms (e.g., such as found during intra-aortic balloon pump use) can lead to inaccurate blood pressure readings. If you observe a questionable value, re-check the patient's pressure in question by alternate means before administering medication or therapy.
- ◆ The operator should avoid contact with the conductive parts of the appurtenance when it is being connected or applied.
- ◆ Disposable IBP transducer or domes should not be reused.

- ◆ Use only the pressure transducer designated by our company.
- ◆ Check transducer cables fault detection before beginning the monitoring phase. If you unplug the transducer of the channels from the socket, the screen should display the error message and the audible alarm should be activated. The other channel should work the same way.
- ◆ If any kind of liquid, other than solution to be infused in pressure line or transducer, is splashed on the equipment or its accessories or enters the transducer or the monitor, contact the hospital service center immediately.
- ◆ If there are air bubbles in the pressure line or the transducer, you should flush the system with solution to be infused.
- ◆ Calibrate the instrument either whenever a new transducer is used, or as frequently as indicated by your hospital procedures policy.

PREPARATION FOR MONITORING

Preparing for invasive pressure monitoring requires the following steps:

- Installation of Transducer Cable
- Kit Set Up
- Purging Air from the Lines
- Zeroing, Leveling and Calibration
- Connecting monitoring system to patient
- Set IP channel and label
- Rescale the IP waveform
- Set the alarm limits
- Select printer option

INSTRUCTIONS FOR USE OF TRANSDUCER MONITORING KIT

INSTALLATION OF TRANSDUCER CABLE

1. Insert the plug of IBP transducer cable into the corresponding sensor socket on the left panel of the monitor and check that the monitor is switched on.
2. Prepare the pressure tubing and transducer by flushing the system with normal saline solution. Ensure the system is free of air bubbles.
3. Connect the patient catheter to the pressure line; making sure that there is no air present in the catheter or pressure line.
4. Position the transducer so that it is level with the patient's heart, approximately the midaxillary line.
5. Check if you have selected the correct label.
6. Zero the transducer.

KIT SET UP

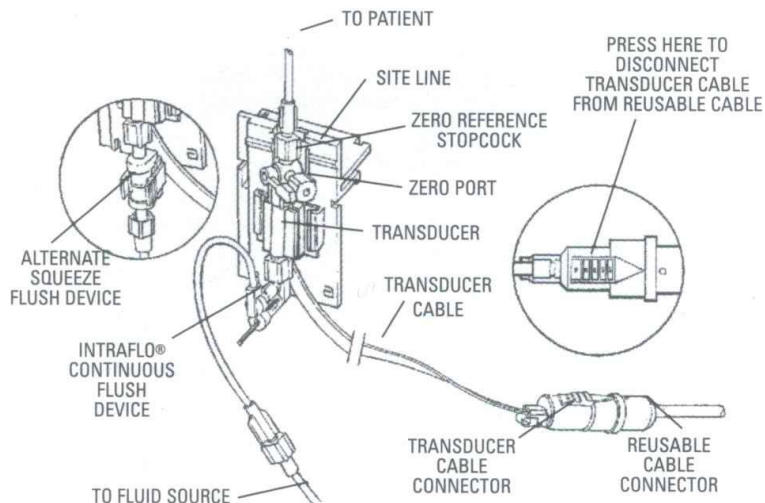

This section detail gives detailed instructions for how to use the disposable transducer monitoring kit.

PATIENT MOUNT

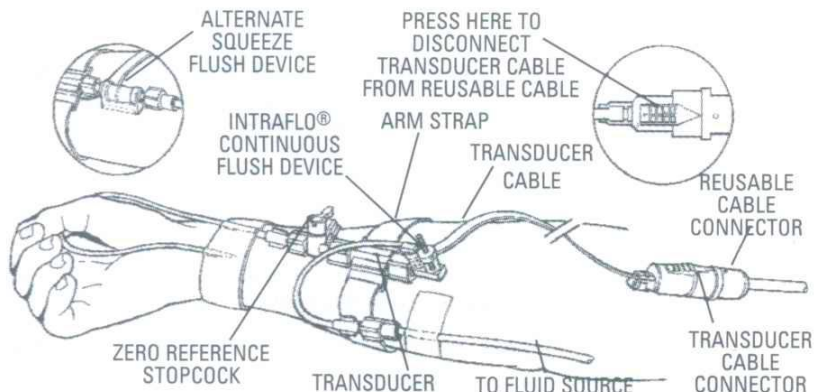

This section detail gives detailed instructions for how to use the disposable transducer monitoring kit.

IBP SETUP

Touch the P1 or P2 Waveform or Parameter Area to open the IBP Setup menu, see below:

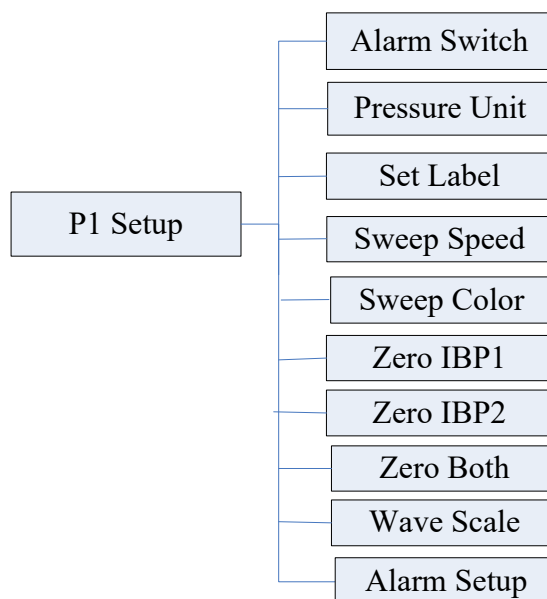



Figure 25: Tree Diagram for IBP1 or IBP2 Setup Menu

ALARM SWITCH

Can be ON or OFF, and the factory setting is **ON**. When the alarm is ON, the alarm is activated. When the alarm is **OFF**, the alarm indicator will not light up, the corresponding alarm parameter will not flash and corresponding parameter area will display the  icon.

PRESSURE UNIT

mmHg and KPa are for choice, the factory setting is mmHg.

[NOTE]: The pressure unit is displayed in accord with setup of NIBP menu.

SET LABEL

ART, PA, CVP, RAP, LAP and ICP are available.

SWEEP SPEED

Choose from **12.5mm/s** and **25mm/s**. The factory setting is **25mm/s**.

SWEEP COLOR

Choose from White, Gray, Red, Yellow, Green, Cyan, Blue, and Magenta. The default setting is Red.

WAVEFORM SCALE

Select “waveform scale” to call up the following menu:

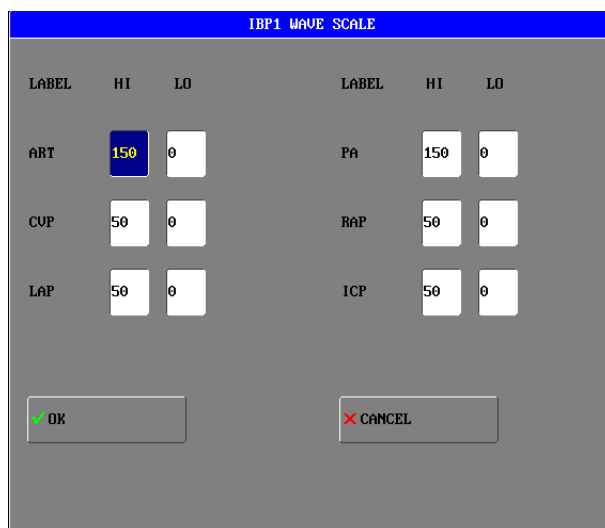

Figure 26: Window for IBP1 or IBP2 Wave Scale

The waveform and corresponding scale values will be displayed in the IBP waveform area. These scales can be set according to the table given below:

HI: IBP value of High Limit scale;

LO: IBP value of Low Limit scale.

Labels	Hi	Lo
ART	50-300	0-100
PA	20-150	-10-50
CVP	0-150	-10-150
RAP	0-150	-10-150
LAP	0-150	-10-150
ICP	0-150	-10-150

ALARM SETUP

Press the **alarm setup** item to open the IBP1 or IBP2 alarm setup menu:

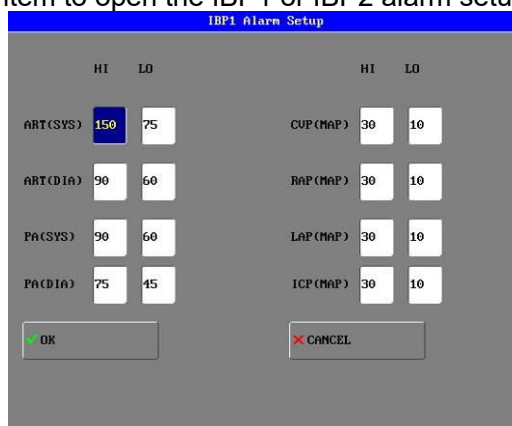

Figure 27: Window for IBP1 or IBP2 Alarm Setup

The alarm setup range for high or low is from 0 to 300mmHg for the ART label. The factory setting for the high limit is 150 mmHg. The factory setting for the low limit is 75 mmHg.

The alarm setup range for high or low is from -10 to 120mmHg for the PA label. The factory setting for the SYS high limit is 90 mmHg. The factory setting for the SYS low limit

is 60 mmHg. The factory setting for the DIA high limit is 75 mmHg. The factory setting for the DIA low limit is 45 mmHg.

The alarm setup range for high or low is from -10 to 40mmHg for the CVP, RAP, LAP and ICP labels. The factory setting for the MAP high limit is 30 mmHg. The factory setting for the MAP low limit is 10 mmHg.

SET TRANSDUCER ZERO

After the system has been primed and mounted, zero the transducer. The following procedure should be completed periodically.

1. Turn zero reference stopcock "off" to the patient and remove the yellow, non-vented cap from the side port that opens the zero reference stopcock to the air.

[NOTE]

The air-fluid interface of the zero reference stopcock should be at or near the right atrial (mid-axillary) level.

2. Open the IBP Setup menu and then choose the "Zero IBP" option. You can meanwhile zero IBP1 and IBP2.

Once it connects with an invasive pressure transducer, the monitor will seek a steady pressure for zeroing. A sequence of on-screen status messages will be displayed.

- a) As soon as the power switch is turned on, "SENSOR OFF!" will be displayed on the screen in the message highlight area.
- b) When an invasive pressure transducer is inserted into the IP receptacle on the left side panel of the monitor, the initial waveform may be visible immediately based on the most recently selected scale. The waveform scale numbers are not shown until transducer is zeroed. If the pressure transducer or connected cable is defective, the on-screen message "SENSOR OFF, UNABLE TO ZERO!" will remain on the screen. In this case, try another transducer or another cable.

3. Turn zero reference stopcock "off" to the side port. Replace non-vented yellow cap.

[NOTE]

- ◆ It is the user's responsibility to ensure that a zero procedure has recently been done on the transducer, otherwise, there will not be a recent, valid zero value for the instrument to use, which may result in inaccurate measurement results.
- ◆ Turn off patient 3-way stopcock before you start the zero procedure.
- ◆ The transducer must be vented to atmospheric pressure before the zero procedure.

PROMPT MESSAGE

Messages	Descriptions
OVERANGE, ZERO FAIL!	Make sure that the stopcock is vented to atmospheric pressure. If the problem persists, contact service representative if necessary.
TIMED OUT, ZERO FAIL!	Make sure that monitor is not in DEMO mode. Contact service representative if necessary.
SENSOR OFF, UNABLE TO ZERO!	Make sure that channel 1 or channel 2's transducer is not turned off, and then proceeds zeroing.
ZERO IN PROCESS!	A zero is currently in progress.
ZERO OK!	The zero procedure has completed.

MAINTAINENCE AND CLEANING

Make sure that the device is switched off and disconnected from the power cable before cleaning the monitor or the transducer.

The disposable transducers and caps are a single-use kit and must not be re-sterilized or re-used.

ANESTHETIC AGENT MONITORING (OPTIONAL, PHASEIN)

PHASEIN IRMA™ MAINSTREAM PROBE

- INTRODUCTION
- SAFETY
- SYSTEM ASSEMBLY INSTRUCTION
- ZEROING PROCEDURE
- ALARMS
- CLEANING
- MAINTENANCE

PHASEIN ISA™ SIDESTREAM ANALYZER

- INTRODUCTION
- SAFETY
- ANALYZER SYSTEM SET-UP
- PRE-USE CHECK
- CONSUMABLE
- ALARMS
- AUTOMATIC ZEROING
- CLEANING
- MAINTENANCE
- MAC CALCULATION
- ADVERSE EFFECTS ON PERFORMANCE
- ANESTHETIC AGENT DISPLAY
- ANESTHETIC AGENT WAVEFORM SETUP
- ANESTHETIC AGENT PARAMETER SETUP

PHASEIN IRMA™ MAINSTREAM PROBE

INTRODUCTION

PHASEIN IRMA™ mainstream multi-gas probe is intended for gas monitoring of adults, pediatric and infant patients in anesthesia, intensive care and emergency care.

The IRMA probe comprises a state-of-the-art, single path, nine-channel non-dispersive infrared (NDIR) gas bench, a barometric pressure sensor, a power regulator, a CPU and a RS-232 digital interface. The unit weighs less than 25 g.

The probe is available in various configurations for different clinical applications. Concentrations of carbon dioxide, nitrous oxide, Halothane, Enflurane, Isoflurane, Sevoflurane and Desflurane in different combinations are determined together with derived parameters such as respiration rate, waveform data and inspired/expired concentrations of all gases.

The IRMA probe snaps in place on the IRMA airway adapter that includes PHASEIN's XTP™ windows. The airway adapter is inserted between the endotracheal tube and the breathing circuit, and the gas measurements are obtained through the XTP windows in the sides of the adapter.

Running on a standard low voltage DC, the IRMA probe is designed with portability in mind and has low power consumption, typically less than one watt. It has been specially designed to be extremely easy to integrate in any host device for display of real time and derived breathing gas data.

The IRMA main stream multi-gas probe is intended to be connected to other medical devices for display of real time and derived monitoring data of CO₂, N₂O, and the

anesthetic agents Halothane, Enflurane, Isoflurane, Sevoflurane and Desflurane. It is intended to be connected to a patient breathing circuit for monitoring of inspired/expired gases during anesthesia, recovery and respiratory care. It may be used in the operating suite, intensive care unit, patient room and emergency medicine settings for adult, pediatric and infant patients.

It is not intended to be used as the only means of monitoring a patient. It shall always be used in combination with other vital signs monitoring devices and/or professional human judgments of patient condition. The IRMA probe is intended to be used by trained and authorized health care professionals only.

SAFETY

WARNINGS

- DO NOT use the IRMA Adult/Pediatric airway adapter with infants as the adapter adds 6 ml dead space to the patient circuit.
- Replace the adapter if rainout/condensation occurs inside the airway adapter.
- Use only PHASEIN manufactured IRMA airway adapters.
- DO NOT use the IRMA Infant airway adapter with adults as this may cause excessive flow resistance.
- The IRMA probe is not intended to be in patient contact.
- Incorrect probe zeroing will result in false gas readings.
- The IRMA probe is intended for use by authorized and trained medical personnel only.
- The IRMA probe must not be used with flammable anesthetic agents.
- Disposable IRMA airway adapters shall not be reused. Reuse of the single use adapter can cause cross infection.
- Used airway adapters shall be disposed of in accordance with local regulations for medical waste.
- The IRMA probe is intended only as an adjunct in patient assessment. It must be used in conjunction with other assessments of clinical signs and symptoms.
- DO NOT place the IRMA airway adapter between the endotracheal tube and an elbow as this may allow patient secretions to block the adapter windows and result in incorrect operation.
- To keep secretions and moisture from pooling on the windows, always position the IRMA probe in a vertical position with the LED pointing upwards.
- DO NOT use the IRMA airway adapter with metered dose inhalers or nebulized medications as this may affect the light transmission of the airway adapter windows.

CAUTIONS

- Never sterilize or immerse the IRMA probe in liquid.
- DO NOT autoclave the devices as this will damage them.
- DO NOT apply tension to the sensor cable.
- DO NOT operate the device outside the temperature environment
- (U.S.): Federal law restricts this device to sale by or on the order of a physician.

SYSTEM ASSEMBLY INSTRUCTION

SET-UP

1. Plug the IRMA connector into the Patient Monitor EtCO₂/Gas socket and switch the power on.
2. Snap the IRMA probe on top of the IRMA airway adapter. It will click into place when properly seated.

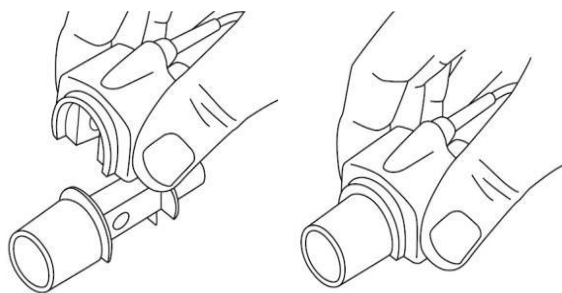

3. A green LED indicates that the IRMA probe is ready for use.



4. Connect the 15 mm male connector of IRMA/airway adapter to the breathing circuit Y-piece.

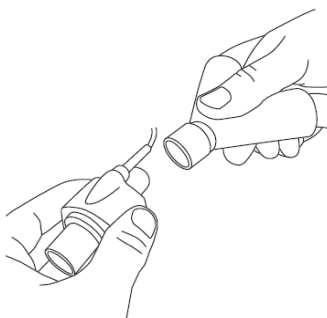

5. Connect the 15mm female connector of IRMA/airway adapter to the patient's endotracheal tube.

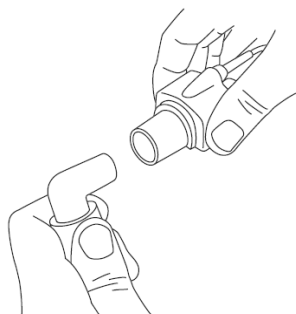

Alternatively, connect an HME (Heat Moisture Exchanger) between the patient's endotracheal tube and the IRMA probe. Placing an HME in front of the IRMA probe protects the airway adapter from secretions and effects of water vapor and eliminates the need of changing the adapter. It allows free positioning of the IRMA probe as well.

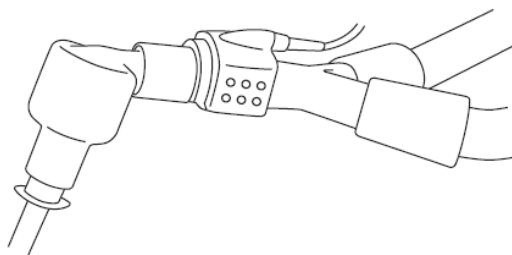

6. Always position the IRMA probe with the status LED pointing upwards unless the IRMA probe is protected with an HME



PLACEMENT OF IRMA PROBE

When connecting IRMA probe to an infant patient circuit, it is important to avoid a direct contact between the IRMA probe and the infant's body.

If, for whatever the reason, the IRMA probe is in direct contact with any parts of the infant's body, an insulation material shall be placed between the IRMA probe and the body.

[WARNING]: The IRMA probe is not intended to be in patient contact

PRE-USE CHECK

Prior to connecting the IRMA airway adapter to the breathing circuit, verify gas readings and waveforms on the monitor before connecting the airway adapter to the patient circuit. Perform the tightness check of the patient circuit with the IRMA probe snapped on the IRMA airway adapter.

ZEROING PROCEDURE

[WARNING]: Incorrect probe Zeroing will result in false gas readings.

In order to secure high precision of the IRMA probe measurements the following zeroing recommendations should be followed.

Zeroing is performed by snapping a new IRMA airway adapter onto the IRMA probe, without connecting the airway adapter to the patient circuit, and then using OMNI II to transmit a Zero reference command to the IRMA probe.

Special care should be taken to avoid breathing near the airway adapter before or during the Zeroing procedure. The presence of ambient air (21% O₂ and 0% CO₂) in the IRMA airway adapter is of crucial importance for a successful Zeroing. Always perform a pre-use

check after zeroing the probe.

IRMA CO₂ probes:

Zeroing needs to be performed ONLY when an offset in gas values is observed, or when an unspecified accuracy message is displayed.

Allow 10 seconds for warm up of the IRMA CO₂ probe after power on and after changing the IRMA airway adapter before proceeding with the Zeroing Procedure. The green LED on the probe will be blinking for approximately 5 seconds while zeroing is in progress.

IRMA AX+ probes:

Zeroing should be performed every time the IRMA airway adapter is replaced, or whenever an offset in gas values or an unspecified gas accuracy message is displayed.

Allow 30 seconds for warm up of the IRMA AX+ probes after power on and after changing the IRMA airway adapter before proceeding with the Zeroing Procedure. The green LED on the probe will be blinking for approximately 5 seconds while zeroing is in progress.

ZERO BY MONITOR

After install the PHASEIN gas module, and Click the Anesthetic Agent Waveform and Parameter Area to open the menu of Multi-Gas Setup→Advanced setup→ manual zero, Monitor will conduct a zero procedure and “zero in progress” message will be displayed.

ALARMS

GAS ALARM LIMIT

Gas type	HIGH (%)	LOW(%)
FIAGT	5	0
ETAGT	5	0
FICO ₂	0.5	0
ETCO ₂	8	2
FIN ₂ O	100	0
FIO ₂	100	18
ETO ₂	100	5

STATUS LED ON IRMA PROBE

Status	Meaning
Steady green light	System OK
Blinking green light	Zeroing in progress
Steady blue light ¹⁾	Anesthetic agent present
Steady red light	Sensor error
Blinking red light	Check adapter

[NOTE]: 1) Valid for IRMA AX++ probes only

CLEANING

The IRMA probe can be cleaned using a cloth moistened with maximum 70% ethanol or maximum 70% isopropyl alcohol.

Remove the disposable IRMA Airway Adapter prior to cleaning the IRMA probe.

[CAUTION]: Never sterilize or immerse the IRMA probe in liquid.

MAINTENANCE

Gas readings should be verified at regular intervals with a reference instrument or with calibration gas. The recommended interval is once every year.

PHASEIN ISA™ SIDESTREAM ANALYZER

INTRODUCTION

The ISA product family consists of three types of sidestream gas analyzers (ISA CO₂, ISA AX+ and ISA OR+), which are intended to be connected to OMNI II Patient Monitor for measuring breath rate and the following breathing gases:

ISA CO₂: CO₂

ISA AX+: CO₂, N₂O, Halothane, Isoflurane, Enflurane, Sevoflurane and Desflurane

ISA OR+: CO₂, O₂, N₂O, Halothane, Isoflurane, Enflurane, Sevoflurane and Desflurane

ISA CO₂, ISA AX+ and ISA OR+ are intended to be connected to a patient breathing circuit for the monitoring of inspired/expired gases during anesthesia, recovery and respiratory care. The intended environment is the operating suite, intensive care unit and patient room. ISA CO₂ is also intended to be used in road ambulances. The intended patient population is adult, pediatric and infant patients.

[NOTE 1]: An ISA sidestream gas analyzer should never be used as the only means of monitoring a patient.

[NOTE 2]: An ISA sidestream gas analyzer shall only be connected to medical devices approved by PHASEIN.

PATENTS

PHASEIN AB holds the following patents regarding products described in this manual: SE519766; SE519779; SE523461; SE524086. Other patents are pending.

TRADEMARKS

PHASEIN IRMA™, PHASEIN ISA™, PHASEIN XTP™, Sigma Multigas Technology™, LEGI™, Nomoline™, IRMA EZ Integrator™, PHASEIN Gas Master™ and PHASEIN Gas Master™ are trademarks of PHASEIN AB.

SAFETY

CLASSIFICATION

- ◆ According to the degree of safety of application in the presence of FLAMMABLE ANAESTHETIC MIXTURE WITH AIR, OR WITH OXYGEN OR NITROUS OXIDE, the ISA is not suitable for use in the presence of FLAMMABLE ANAESTHETIC MIXTURE WITH AIR, OR WITH OXYGEN OR NITROUS OXIDE.
- ◆ According to the degree of protection against harmful ingress of water: IPX4
- ◆ According to sterility: The ISA system contains no sterile parts.
- ◆ According to the model of operation: CONTINUOUS OPERATION
- ◆ According to the degree of protection against electric shock:
Nomoline Family sample lines are classified as DEFIBRILLATION PROOF TYPE BF APPLIED PART
- ◆ The combination of OMNI II and ISA shall be considered a ME SYSTEM.

WARNINGS

- ◆ The ISA sidestream gas analyzer is intended for use by authorized and trained medical personnel only.
- ◆ Use only Nomoline sampling lines manufactured by PHASEIN.
- ◆ The ISA sidestream gas analyzer must not be used with flammable anesthetic agents.
- ◆ Carefully route the sampling line to reduce the risk of patient entanglement or strangulation.
- ◆ DO NOT re-use disposable sampling lines.
- ◆ DO NOT lift the ISA/OMNI II by the sampling line as it could disconnect from the ISA/OMNI II, causing the ISA/OMNI II to fall on the patient.
- ◆ Used disposable sampling lines shall be disposed of in accordance with local regulations for medical waste.
- ◆ DO NOT use adult/pediatric type sampling line configurations with infants, as this may add dead space to the patient circuit.
- ◆ DO NOT use infant type sampling line configurations with adults, as this may cause excessive flow resistance.
- ◆ DO NOT use the ISA sidestream gas analyzer with metered-dose inhalers or nebulized medications as this may clog the bacteria filter.
- ◆ Check that the gas sample flow is not too high for the present patient category.
- ◆ Since a successful zeroing requires the presence of ambient air (21% O₂ and 0% CO₂) in the gas analyzer, ensure that the ISA is placed in a well ventilated place. Avoid breathing near the ISA sidestream gas analyzer before or during the zeroing procedure.
- ◆ The Nomoline sampling line and its interfaces are non-sterile devices. To avoid damage, do not autoclave any part of the sampling line.
- ◆ Never sterilize or immerse the ISA sidestream gas analyzer in liquid.
- ◆ Measurements can be affected by mobile and RF communications equipment. Make sure that the ISA sidestream gas analyzer is used in the electromagnetic environment specified in this manual.
- ◆ ISA sidestream gas analyzer is intended only as an adjunct in patient assessment. It must be used in conjunction with other assessments of clinical signs and symptoms.
- ◆ Replace the sampling line if the sampling line input connector starts flashing red, or a Nomoline occlusion message is displayed on the OMNI II
- ◆ No modification of this equipment is allowed without authorization of the manufacturer. If this equipment is modified, appropriate inspection and testing must be conducted to ensure continued safe operation.
- ◆ ISA sidestream gas analyzers are not designed for MRI environments.
- ◆ During MRI scanning, the OMNI II must be placed outside the MRI suite.
- ◆ Use of high frequency electrosurgical equipment in the vicinity of the ISA/OMNI II may produce interference and cause incorrect measurements.

- ◆ DO NOT use external ambient cooling of the ISA device.
- ◆ DO NOT apply negative pressure to the Nomoline (i.e. by a syringe) to remove condensed water.
- ◆ Too strong positive or negative pressure in the patient circuit might affect the sample flow.
- ◆ Strong scavenging suction pressure might affect the sample flow.
- ◆ Exhaust gases should be returned to the patient circuit or a scavenging system.
- ◆ Always use a bacteria filter on the evac side if sampled gas is intended to be re-breathed.
- ◆ DO NOT place the ISA gas analyzer in any position that might cause it to fall on the patient.

CAUTIONS

- ◆ The ISA “plug-in and measure” analyzers should be securely mounted in order to avoid the risk of damage to the ISA.
- ◆ DO NOT apply tension to the ISA sidestream gas analyzer cable.
- ◆ DO NOT operate the ISA sidestream gas analyzer outside the specified operating temperature environment.
- ◆ (US Only) Caution: Federal law restricts this device to sale by or on the order of a licensed healthcare practitioner.

ANALYZER SYSTEM SET-UP

1. Securely mount the ISA analyzer.



2. Connect the ISA analyzer interface cable to the OMNI II Patient Monitor.

3. Connect a Nomoline Family sampling line to the ISA analyzer input connector.

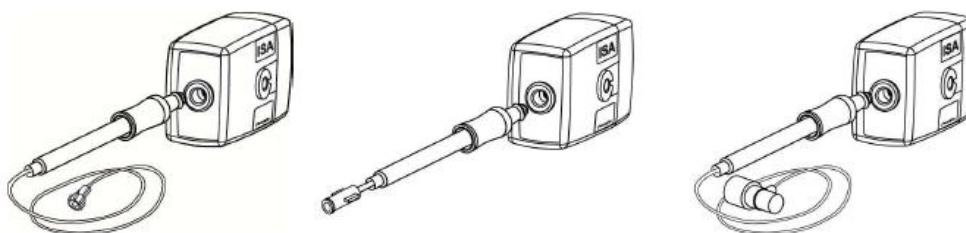

4. Connect the gas sample exhaust port to a scavenging system or return the gas to the patient circuit to prevent pollution of the operation room when N₂O and/or anesthetic agents are being used.
5. Power up the OMNI II Patient Monitor.
6. A green LED indicates that the ISA analyzer is ready for use.
7. Perform a pre-use check as described in section “Pre Check”.

PRE-USE CHECK

Before connecting the Nomoline sampling line to the breathing circuit, do the following:

1. Connect the sampling line to the ISA gas inlet connector (LEGI)
2. Check that the LEGI shows a steady green light (indicating that the system is OK)
3. For ISA AX+ module with O₂ option fitted:
Check that the O₂ reading on the monitor is correct (21%).
4. Breathe into the sampling line and check that valid CO₂ waveforms and values are displayed on the OMNI II Patient Monitor.

5. Occlude the sampling line with a fingertip and wait for 10 seconds.
6. Check that an occlusion alarm is displayed and that the LEGI shows a flashing red light.
7. If applicable:
Perform a tightness check of the patient circuit with the sampling line attached.

CONSUMABLE

SAMPLING

A sidestream gas analyzer continuously removes a gas sample flow from the respiratory circuit, for example a nasal cannula, a respiratory mask or the Y-piece of an intubated patient. The gas sample is fed through a sampling line to the gas analyzer. The sampled gas is usually warm and humid, and cools down in contact with the wall of the sampling line. Water therefore condenses in form of droplets on the inner wall of the sampling line. These droplets could potentially occlude the sampling line and interfere with the gas measurement.

THE NOMOLINE FAMILY

To overcome the shortfalls of current gas sampling solutions, the Nomoline Family sampling lines have been developed for the ISA sidestream gas analyzers.

Unlike traditional solutions that remove water vapor and collect water in a container, the Nomoline Family sampling lines incorporates a unique water separation (NO Moisture) section, which removes condensed water. The NOMO section also has a bacteria filter which protects the gas analyzer from water intrusion and cross contamination.

The Nomoline Family sampling lines are specially designed for 50 ml/min low sample flow applications. The Nomoline Family sample lines have a very low dead space that results in an ultra-fast rise time, making measurements of CO₂, N₂O and anesthetic agents possible even at high respiratory rates. ISA sidestream gas analyzers are therefore suitable for adult, pediatric and infant patients.

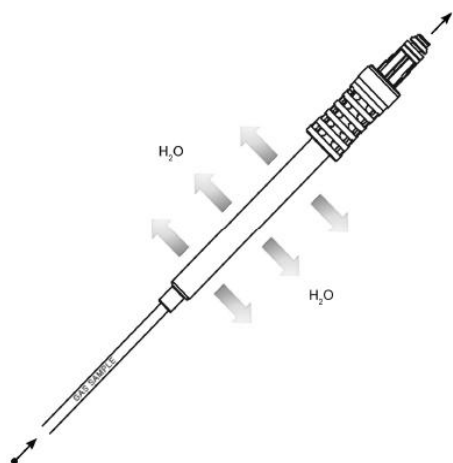

The Nomoline Family sampling lines are available in the following versions:



(The Nomoline Family sampling lines; Nomoline with male Luer Lock connector, Nomoline Airway Adapter Set with integrated airway adapter and the Nomoline Adapter with female Luer Lock connector.)

The Nomoline Airway Adapter Set with integrated airway adapter can be used with intubated patients.

The Nomoline with a male Luer Lock type connector is compatible with any normal configuration that uses a female Luer Lock connector. When connecting to a T-adapter, be sure to use a PHASEIN T-adapter that samples the gas from the center of the T-adapter (see below).

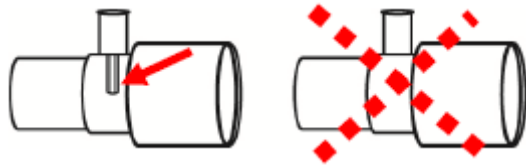

(For optimal water handling, always use T-adapters with the sampling point in the center of the adapter, as shown to the left in the figure above.)

The Nomoline Adapter with female Luer Lock connector connects to a standard male Luer to Luer sample line (Nomo Extension) as well as to different kinds of third-party cannulas for oral and nasal sampling. Combining the Nomoline Adapter with the Nomo Extension and T-adapter results in a similar product as the Nomoline Airway Adapter Set (see below).

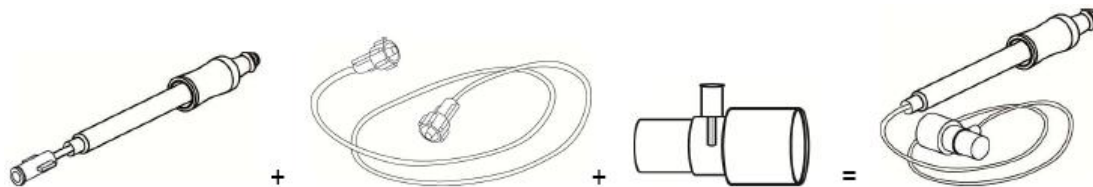

(Combining Nomoline Adapter with the Nomo Extension and T-adapter results in a similar product as the Nomoline Airway Adapter Set.)

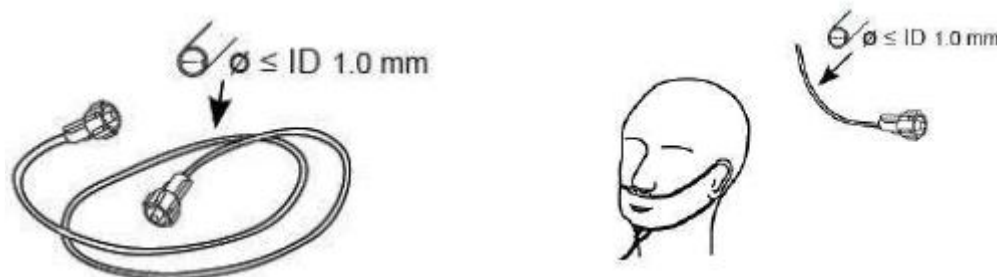

(If using third-party sample tubes or cannula, make sure that the inner diameter does not exceed 1 mm since this will increase the ISA's total system response time.)

[NOTE]: Using sample tubes or cannula with larger inner diameter than 1 mm will increase the response time of ISA's total system.

[WARNING]: DO NOT apply negative pressure to remove condensed water from the Nomoline Family sampling line.

[WARNING]: DO NOT use the ISA gas analyzer with metered-dose inhalers or nebulized medications as this may clog the bacteria filter.

[WARNING]: DO NOT apply negative pressure to remove condensed water from the Nomoline Family sampling line.

[WARNING]: Dispose nomoline family sampling lines in accordance with local regulations for biohazardous waste.

[WARNING]: Use only airway T-adapters with the sampling point in the center of the adapter.

[WARNING]: DO NOT re-use disposable single-patient use Nomoline Family sampling lines due to the risk of cross contamination.

[WARNING]: DO NOT sterilize or immerse Nomoline Family sampling lines in liquid.

[WARNING]: DO NOT use T-adapter with infants, as this adds 7 ml dead space to the patient circuit.

[WARNING]: Do only use sample lines intended for anesthetic agents if N₂O and/or anesthetic agents are being used.

REPLACEMENT OF NOMOLINE AND NOMOLINE AIRWAY ADAPTER SET

The Nomoline and Nomoline Airway Adapter Set are single-patient use products. They should be replaced according to good clinical practice or when an occlusion message appears. Occlusion occurs when the sample flow is too low. This is indicated by a flashing red LEGI together with a message on OMNI II.

REPLACEMENT OF NOMOLINE ADAPTER

The Nomoline Adapter is a multiple-patient use product. The Nomoline Adapter should be replaced according to good clinical practice or when an occlusion message appears. Occlusion occurs when the sample flow is too low. This is indicated by a flashing red LEGI together with a message on OMNI II.

REPLACEMENT OF T-ADAPTER AND NOMO EXTENSION

The T-adapter and Nomo Extension are single-patient use products. They should be replaced according to good clinical practice or when an occlusion message appears. Occlusion occurs when the sample flow is too low. This is indicated by a flashing red LEGI together with a message on OMNI II.

ALARMS

Gas Alarm limit

Gas type	HIGH (%)	LOW (%)
FIAGT	5	0
ETAGT	5	0
FICO ₂	0.5	0
ETCO ₂	8	2
FIN ₂ O	100	0
FIO ₂	100	18
ETO ₂	100	5

Status indicated by ISA LED

Indication	Status
Steady green light	System OK
Blinking green light	Zeroing in progress

Steady blue light	Anesthetic agent present
Steady red light	Sensor error
Blinking red light	Check sampling line

AUTOMATIC ZEROING

The infrared gas analyzer needs to establish a zero reference level for the CO₂, N₂O and anesthetic agent gas measurement. This zero calibration is here referred to as "zeroing". ISA sidestream gas analyzers perform zeroing automatically by switching the gas sampling from the respiratory circuit to ambient air. The automatic zeroing is performed every 24 hours, and takes less than 3 seconds for ISA CO₂ gas analyzers and less than 10 seconds for ISA multigas analyzers.

If the ISA sidestream gas analyzer is fitted with an oxygen sensor, the automatic zeroing will also include room air calibration of the oxygen sensor.

[WARNING]: Since a successful zeroing requires the presence of ambient air (21% O₂ and 0%CO₂) in the gas analyzer, ensure that the ISA is placed in a well ventilated place. Avoid breathing near the ISA sidestream gas analyzer before or during the zeroing procedure.

CLEANING

The "plug-in and measure" ISA sidestream gas analyzers should be cleaned on a regular basis.

Use a cloth moistened with max 70% ethanol or isopropyl alcohol to clean the analyzer.

To prevent cleaning liquids and dust from entering the ISA gas analyzer through its LEGI connector, keep the Nomoline sampling line connected while cleaning the analyzer.

[WARNING]:

- The Nomoline sampling lines are non-sterile devices. To avoid damage, DO NOT autoclave any part of the sampling line.
- Never sterilize or immerse the ISA sidestream gas analyzer in liquid. Since a successful zeroing requires the presence of ambient air (21% O₂ and 0%CO₂) in the gas analyzer, ensure that the ISA is placed in a well ventilated place. Avoid breathing near the ISA sidestream gas analyzer before or during the zeroing procedure.

MAINTENANCE

Once every year, or whenever gas readings are questionable, perform a leakage check as below and verify gas readings with a reference instrument or with calibration gas.

Calibration gas can be ordered from PHASEIN AB (www.phasein.com).

LEAKAGE CHECK

1. Connect a new Nomoline sampling line with male luer lock to the ISA LEGI and check that the LEGI shows a steady green light.
2. Connect a short of silicon tubing with an inner diameter of 3/32" (2.4 mm) to the Nomoline male luer.
3. Exhale a long breath into the silicon tubing until the CO₂ concentration is greater than 4.5 vol % or 34 mmHg.
4. Quickly connect the silicon tubing tightly to the exhaust port.
5. Wait 1 minute until the CO₂ concentration has stabilized. Note the value.
6. Wait 1 minute and check that the CO₂ concentration has not decreased more than 0.4 vol% or 3 mmHg. If it has decreased more there is a major leakage in the ISA unit or in the Nomoline. DO NOT operate the ISA if there is a major leakage in the unit.

MAC (Minimum Alveolar Concentration) CALCULATION

Minimum alveolar concentration (MAC) is a standard for comparing the potency of inhalation anesthetics. 1 MAC represents the end-tidal concentration of an agent (at sea level) that, in 50 percent of a tested population, prevents gross muscular movement in response to a painful, standardized stimulus.











The MAC value may be calculated and displayed by using end-tidal (Et) gas concentrations according to the following formula:



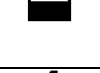





$$MAC = \frac{\%Et(AA1)}{X(AA1)} + \frac{\%Et(AA2)}{X(AA2)} + \frac{\%Et(N2O)}{100}$$

X(AA): HAL=0.75%, ENF=1.7%, ISO=1.15%, SEV=2.05%, DES=6.0%

[NOTE]: Altitude, patient age and other individual factors are not considered in the formula above.

SYMBOLS

Symbol	Title	Explanation
	Instructions for use	Consult instructions for use
	Catalog number	
	Serial number	
	Batch code	
	Year of manufacture	
	Use by date [YYYY-MM-DD]	The device should not be taken into operation after the date accompanying the symbol.
	Temperature limitation	
	Pressure limitation	
	Humidity limitation	
	DO NOT re-use	Nomoline and Nomoline Airway Adapter Set are intended for single patient use
	Biohazardous waste	Nomoline Family sampling lines shall be disposed as biohazardous waste
	For EU only: Waste Electrical and Electronic Equipment (WEEE)	For EU only: Electrical and electric equipment shall be collected and recycled in accordance with (Directive 2002/96/EC)

Symbol	Title	Explanation
	ETL Listing Mark	Conforms to ANSI/AAMI 60601-1:2005 Cert. to CAN/CSA-C22.2 No.60601.1:2008.
	Conformité Européenne	Complies with 93/42/EEC Medical Device Directive when connected to medical devices approved by PHASEIN AB.
IPX4	IP classification indicating level of water protection	"Splash-proof"
Rx ONLY	Rx only	(US Only) Caution: Federal law restricts this device to sale by or on the order of a licensed healthcare practitioner.
	CO ₂	ISA equipped to measure CO ₂ only
	Multigas (AX+ or OR+)	ISA equipped to measure multiple gases
	Sigma Multigas Technology	The product is fitted with PHASEIN Sigma Multigas Technology
	Gas Inlet	See sections 7.1 (build-in module) or 7.2 ("plug-in and measure" analyzer)
	Gas Outlet	See sections 7.1 (build-in module) or 7.2 ("plug-in and measure" analyzer)
	Defibrillation-proof type BF applied part	The applied part of ISA is the Nomoline Family sampling line

ADVERSE EFFECTS ON PERFORMANCE

EFFECTS OF HUMIDITY

The partial pressure and the volume percentage of CO₂, N₂O, O₂ and anesthetic agents depend on the amount of water vapor in the measured gas. The O₂ measurement will be calibrated to show 20.8 vol% at actual ambient temperature and humidity level, instead of showing actual partial pressure. 20.8 vol% O₂ corresponds to the actual O₂ concentration in room air with 0.7 vol% H₂O concentration (at 1013 hPa this equals for example 25°C and 23% RH).

The measurement of CO₂, N₂O, and anesthetic agents (e.g. all gases measured by the IR-bench) will always show the actual partial pressure at the current humidity level.

In the alveoli of the patient, the breathing gas is saturated with water vapor at body temperature (BTPS).

When the breathing gas flows through the sampling line, the gas temperature will adapt to ambient before reaching the gas analyzer. As the NOMO section removes all condensed water, no water will reach the ISA gas analyzer. The relative humidity of the sampled gas will be about 95%.

If CO₂ values at BTPS are required, the following equation can be used:

$$EtCO_2(BTPS) = EtCO_2 * \left(1 - \left(\frac{3.8}{pamb} \right) \right)$$

Where:

EtCO₂ = EtCO₂ value sent from ISA [vol %]

Pamb = Ambient pressure sent from ISA [kPa]

3.8 = Typical partial pressure of water vapor condensed between patient circuit and ISA [kPa]

EtCO₂ (BTPS) = EtCO₂ gas concentration at BTPS [vol%]

O₂ is assumed to be room air calibrated at a humidity level of 0.7 vol% H₂O.

ANESTHETIC AGENT DISPLAY

DISPLAY

Open the PHASEIN Gas module and then choose to display AG waveform in the "Waveform Select" menu. See graph below.

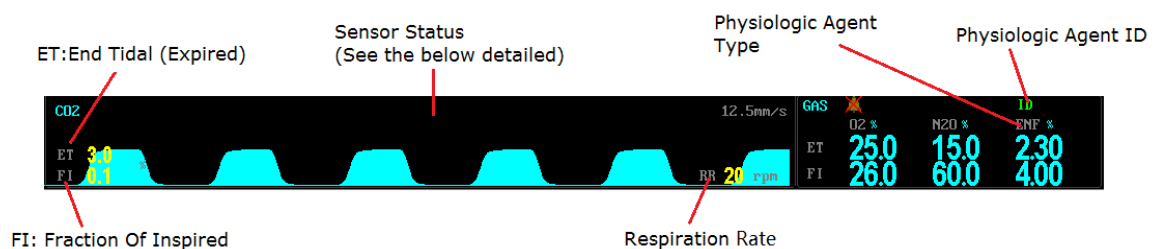

SENSOR STATUS

- Sensor Off
- Check Sample Line
- Sensor error
- Zero in Progress
- Unspecified accuracy

PHYSIOLOGIC AGENT STATUS

ID: The gas module has identified an agent. In this state, the corresponding ID indicates one of the 5 anesthetic agents.

ANESTHETIC AGENT TYPE

HAL: Halothane

ENF: Enflurane

ISO: Isoflurane

SEV: Sevoflurane

DES: Desflurane

ANESTHETIC AGENT SETUP

Touch the Anesthetic Agent Waveform or Parameter Area to open the Multi-Gas Setup menu, see below

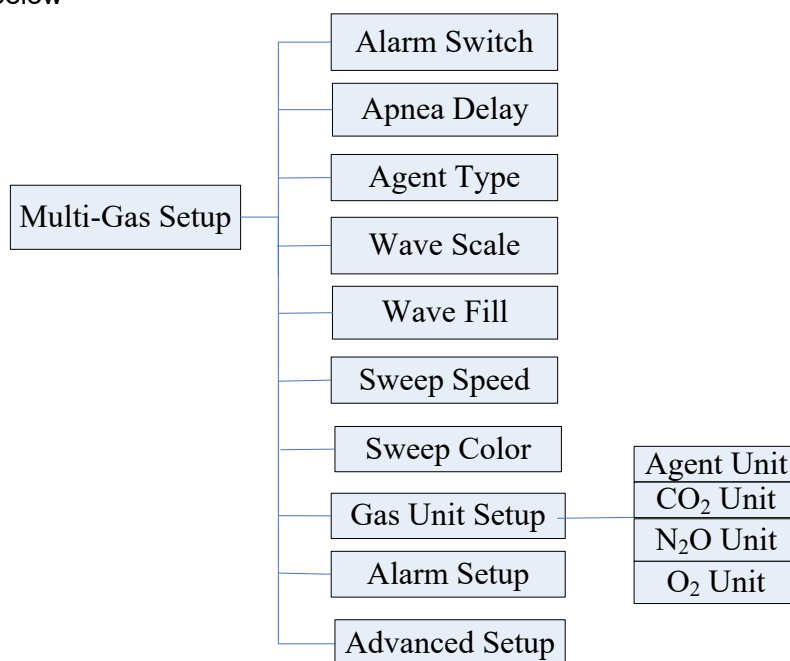



Figure 28: Tree Diagram for Multi-Gas Setup Menu

ALARM SWITCH

ON and OFF for choice, the factory setting is ON. When the choice is ON, the alarm is activated; when the choice is **OFF**, the alarm indicator will not light, the relative alarm parameter will not flash and relative parameter area will display the  icon.

APNEA DELAY

This setting is used to set the no breaths detected time-out. This time-out is the time period in seconds following the last detected breath at which the CO₂ module will signal no breaths detected.

The setting range is 10~60 seconds, and the factory setting is 10 seconds.

AGENT TYPE

“Auto ID”, “Halothane”, “Enflurane”, “Isoflurane”, “Sevoflurane” and “Desflurane” for choice.

If the AAM has no “Auto ID” function, the anesthetic agent type needs to be selected manually.

WAVEFORM SCALE

“0-10%” and “0-20%” are for choice. The factory setting is “0-10%”. Use this setting to adjust the amplitude measurement (size) of the displayed EtCO₂ waveform scale manually.

WAVE FILL

Use this setting to fill in the bottom portion of the waveform on any channel of the display.

SWEEP SPEED

12.5mm/s and 25mm/s are for choice, the factory setting is 12.5mm/s.

SWEEP COLOR

Choose from white, red, green, cyan, blue, yellow, gray and magenta.

GAS UNIT SETUP

Choose from “mmHg”, “kPa” and “%”, the factory setting is %.

ALARM SETUP

	High		Low	
FI Agt	0.0%-20.0% factory setting: 5.0%		0.0%-20.0% factory setting: 0.0%	
ET Agt	0.0%-20.0% factory setting: 5.0%		0.0%-20.0% factory setting: 0.0%	
FI CO2	0 mmHg-76 mmHg factory setting: 4 mmHg		0 mmHg-76 mmHg factory setting: 0 mmHg	
ET CO2	0 mmHg-76 mmHg factory setting: 61 mmHg		0 mmHg-76 mmHg factory setting: 15 mmHg	
RR	0 rpm-100 rpm factory setting:	30 rpm (Adult or Pediatric) 100 rpm (Neonatal)	0 rpm-100 rpm factory setting:	5 rpm (Adult or Pediatric) 30 rpm (Neonatal)
FI N2O	0%-100% factory setting: 100%		0%-100% factory setting: 0%	
ET N2O	0%-100% factory setting: 100%		0%-100% factory setting: 0%	
FI O2	18%-100% factory setting: 100%		18%-100% factory setting: 18%	
ET O2	0%-100% factory setting: 100%		0%-100% factory setting: 5%	

ADVANCED SETUP

ZERO GAS TYPE

“Scrubbed Air/N2/O2”, “Room Air” and “100% O2” for choice, the factory setting is “Room Air”.

O2 COMPENSATIONS

The anesthetic agents in the gas mixture need to be compensated in order to achieve its stated accuracy. The instrument settings for this parameter should be set when the O₂ sensor is unconnected. But when install the O₂ sensor, this function isn't available.

STANDBY MODE

When measurements are temporarily not needed, the monitor can switch the AAM from ‘Operation Mode’ into ‘Standby Mode’ . During standby, some internal components of the module are switched off, which increases the lifetime of the module. When measurements are needed again, the device must be switched back into ‘Operation Mode’ . The latter transition will usually take less than 30 seconds.

ANESTHETIC AGENT MONITORING (OPTIONAL, DRÄGER)

- THEORY OF OPERATION AND DESCRIPTIONS
- PATIENT CONNECTIONS
- ANESTHETIC AGENT DISPLAY
- ANESTHETIC AGENT SETUP
- MAC CALCULATION
- CALIBRATION

THEORY OF OPERATION AND DESCRIPTION

The Anesthetic Agent Module (AAM) incorporates the latest design techniques and solid-state technology to redefine compactness and reliability. Miniaturization and performance advancements lead to an extremely cost-effective measuring of all five relevant anesthetic agents, as well as carbon dioxide and nitrous oxide. Ingenious solid-state design means that there are no moving parts to wear out.

The result is a solution that is highly shock-proof, while featuring low power consumption and an exceptional degree of integration flexibility into the finished product.

The infrared technology consists of a multi-spectral detector that operates according to the principles of absorption measuring and ray mixture. During each use, the infrared light is reflected in four directions after which it passes through a filter. The filters are laid out so that they are only permeable for a small wave length bandwidth in which the analyzed gas shows a particular absorption characteristic. Consequently, it is possible to determine the concentration of the gas, based on the light intensity measured by a sensor. And unlike other sensors, the AAM is not susceptible to cross-sensitivities due to gases like water vapour, ethanol or acetone.

A rapid response time of less than 350 ms for CO₂ and less than 500 ms for other gases enables the AAM to differentiate between inhaled and exhaled gas concentrations. Plus, the functional range of the AAM provides automatic identification of the agent, including identifying and quantifying a mixture of two different anesthetic gases. Yet both sensors are lifetime calibrated and require only minimal maintenance.

WaterLock - the advanced water trap from Dräger Medical protects your gas measuring equipment against infiltration water, bacteria and viruses. This user friendly product improves the longevity and accuracy of your devices. The WaterLock has a guaranteed operating life of four weeks and can be reused as often as needed during this time.

For hygienic draining, all you need to do is remove the water trap from its mounting, insert a commercial syringe and extract the water. The WaterLock owes its high efficiency to two hydrophobic Goretex-membranes made of PTFE. These micro-porous filters have a pore size of only 0.2µm, which is impermeable to condensed water and contaminants. Yet it allows the measured gas to pass through without a noteworthy decrease in pressure. The design of the filter housing creates a self-purification effect that helps prevent clogging.

Furthermore, the system has been constructed to optimize top-level accuracy for real-time curves and render impossible overflows of the water trap tank.

[WARNINGS]:

- ✧ Always test sampling line adapter for a tight connection and proper operation before attaching to a patient.
- ✧ Sevoflurane is an investigative drug and can only be used on humans where authorized by governing agencies within the individual countries.
- ✧ The outputs of the two oscillators are mixed and filtered to produce a signal that is the difference in frequency of the two. The difference frequency is used to calculate the concentration of the selected gas.
- ✧ The response for agent detection depends on the response time of the detector and the sample flow rate. At a flow rate of 140 ml/min., the response time is adequate for breath rates up to eighteen (18) breaths per minute. For breath rates over this, performance may be affected.
- ✧ Since the sensitivity of the gas detector is different for each gas, it is necessary to select which gas is being administered.

[NOTE]:

Patient Waste Gas Removal:

Continuous exposure of Health Care workers to waste anesthetic gases (including halogenated agents and nitrous oxide) is not recommended. Always attach both waste gas connections on the rear of the monitor to the room's gas evacuation system. Avoid venting any waste anesthetic gas directly into the room air as exposure to waste anesthetic gases above the recommended OSHA limits could result.

PATIENT CONNECTIONS

Use only original Infinium Medical Inc. sampling lines and accessories; other sampling lines may cause inaccurate readings and malfunctions. Change sampling line and airway adapter for each patient.

Complete the patient connections following the below steps:

1. Select the suitable Water Trap Cartridge/Adapter and install the fixed seat on the side of the Patient Monitor.
2. Connect the sample line with the water trap adapter.
3. Connect the sample's other end with the patient via airway adapter.
4. Connect Endotracheal Tube with an anesthesia or ventilator circuit with a side stream outlet.

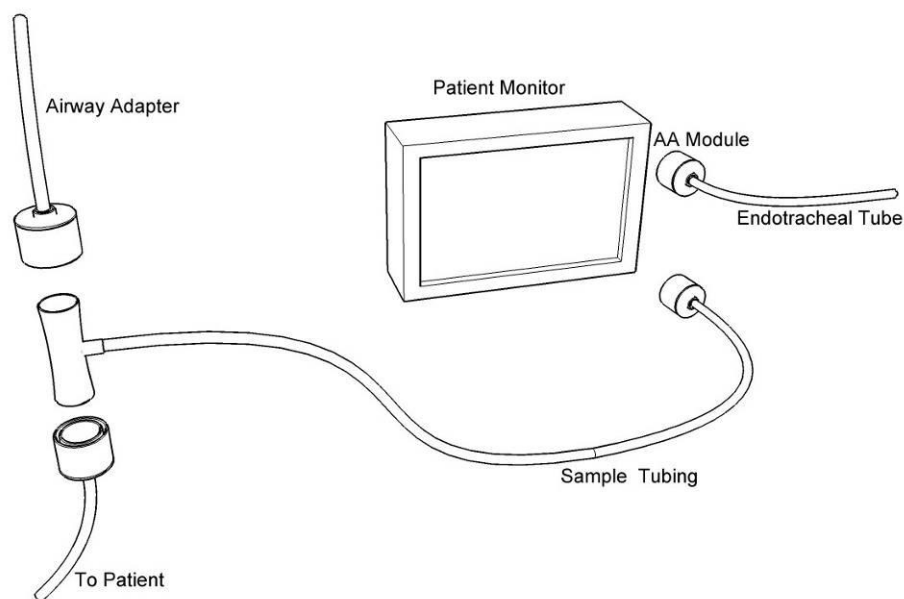

ANESTHETIC AGENT DISPLAY

DISPLAY

Open the DRAGER Gas module and then choose to display Gas waveform in the "Waveform Select" menu. See graph below.

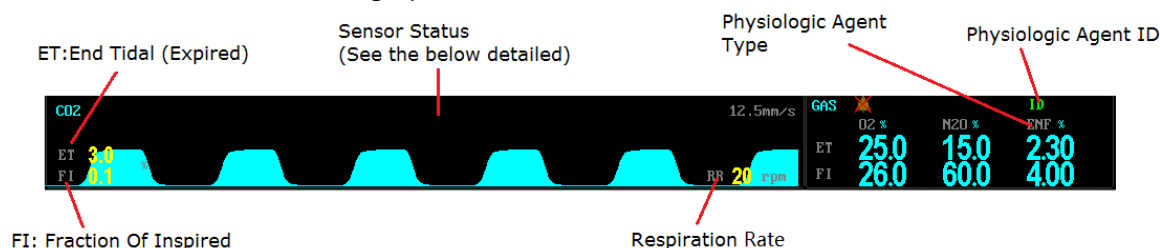

SENSOR STATUS

- Sensor Off
- Check Watertrap /Sample Line
- Hardware Failure
- Occlusion
- Zero in Progress
- Sensor Standby (See the menu setup below)
- Sensor Warm Up

The Zero Procedure has the purpose to maintain proper accuracy of the measurements.

Zero requests typically occur after the warm-up phase (a couple of minutes or so after start-up) of a sensor component and then again in regular time intervals (every two hours). Under certain circumstances the module will indicate extraordinary zero requests (e.g. after returning from Standby Mode or Switched Off mode). Most AAM have an internal zero management that schedules the regular zero requests in an intelligent way, such that zero requests for several individual parameters are synchronized with each other. By this, zero requests will occur less frequent, and also the zeroing process can be conducted for several gas parameters at the same time. As a consequence, zeroing will consume less of the operation time and the availability of measured data is improved.

The time needed for conducting a Zero Procedure varies between different sensor heads. Typically, it will require between ca. 20 seconds and 1 minute. In the course of the Zero Procedure, the setting of the valve and the pump change temporarily. When the Zero Procedure is finished, the module will automatically restore the valve and pump settings prior to the procedure.

PHYSIOLOGIC AGENT STATUS

ID: The AAM has identified an agent. In this state, the corresponding ID indicates one of the 5 anesthetic agents.

CALC: Calculate..., The Patient Gas Module is currently busy with identifying the present agent(s). This status typically lasts for a couple of seconds.

“Calculate” is a condition in which the agent mixture algorithm is not sure about the detected agents. Usually it comes up if no single agent history is available and a mixture situation occurs. Then it may stay for a few seconds.

OVER: Overflow

The gas concentration has increased above the maximum threshold.

MIX: Mixture

The Patient Gas Module can not identify the present agent(s). The reason is the presence of

- Either a mixture of too many anesthetic agents
- or other unidentifiable gases

FORCE:

Forced mode is used for the non-automatic Identification.

These sensors are not able to identify which of the volatile anesthetic agents Halothane, Enflurane, Isoflurane, Sevoflurane or Desflurane is contained within the patient gas. This type of sensor is always operated in “Forced Mode”.

In this mode the monitor will specify the type of anesthetic agent for the AAM with the command “Select Anesthetic Agent”. The ID of the Physiologic Agent then reflects the forced agent.

EST: Estimated

The AAM can not identify the present agent(s) but only give an estimation of one of the present agents. The reason is the presence of

- Either a mixture of too many anesthetic agents
- Or other unidentifiable gases

ANESTHETIC AGENT TYPE

HAL	Halothane
ENF	Enflurane
ISO	Isoflurane
SEV	Sevoflurane
DES	Desflurane

ANESTHETIC AGENT SETUP

Touch the Anesthetic Agent Waveform or Parameter Area to open the Multi-Gas Setup menu, see below

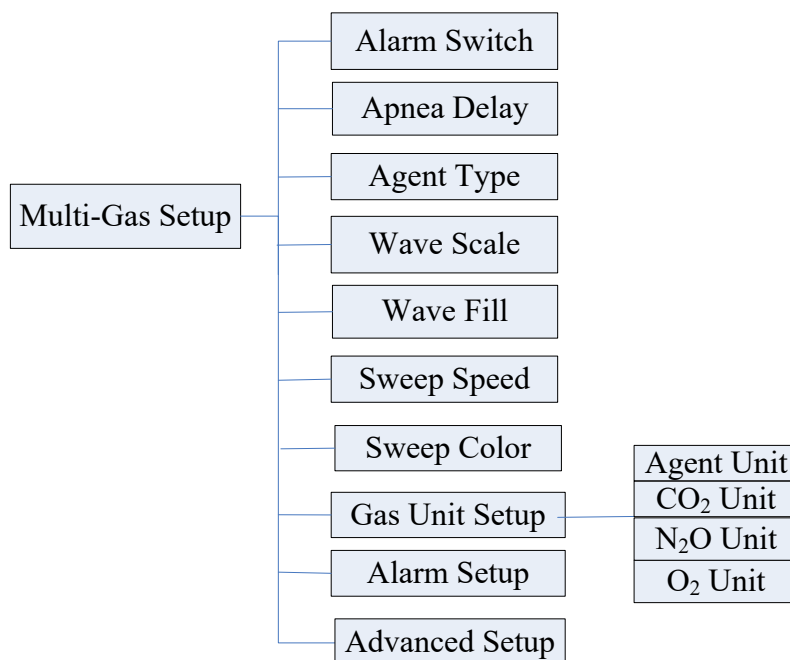



Figure 29: Tree Diagram for Multi-Gas Waveform Setup Menu

ALARM SWITCH

ON and OFF for choice, the factory setting is ON. When the choice is ON, the alarm is activated; when the choice is **OFF**, the alarm indicator will not light, the relative alarm parameter will not flash and relative parameter area will display the  icon.

APNEA DELAY

This setting is used to set the no breaths detected time-out. This time-out is the time period in seconds following the last detected breath at which the CO₂ module will signal no breaths detected.

The setting range is 10~60 seconds, and the factory setting is 10 seconds.

AGENT TYPE

“Auto ID”, “Halothane”, “Enflurane”, “Isoflurane”, “Sevoflurane” and “Desflurane” for choice.

If the AAM has no “Auto ID” function, the anesthetic agent type needs to be selected manually.

WAVEFORM SCALE

“0-10%” and “0-20%” for choice, the factory setting is “0-10%”. Use this setting to adjust the amplitude measurement (size) of the displayed EtCO₂ waveform scale manually.

WAVE FILL

Use this setting to fill in the bottom portion of the waveform on any channel of the display.

SWEEP SPEED

12.5mm/s and 25mm/s are for choice, the factory setting is 12.5mm/s.

SWEEP COLOR

It provides white, red, green, cyan, blue, yellow, gray and magenta which can be chosen.

GAS UNIT SETUP

“mmHg”, “kPa” and “%” for choice, the factory setting is %.

ALARM SETUP

	High	Low
FI A_gt	0.0%-20.0% factory setting: 5.0%	0.0%-20.0% factory setting: 0.0%
ET A_gt	0.0%-20.0% factory setting: 5.0%	0.0%-20.0% factory setting: 0.0%
FI CO₂	0 mmHg-76 mmHg factory setting: 4 mmHg	0 mmHg-76 mmHg factory setting: 0 mmHg
ET CO₂	0 mmHg-76 mmHg factory setting: 61 mmHg	0 mmHg-76 mmHg factory setting: 15 mmHg
RR	0 rpm-100 rpm factory setting: 30 rpm (Adult or Pediatric) 100 rpm (Neonatal)	0 rpm-100 rpm factory setting: 5 rpm (Adult or Pediatric) 30 rpm (Neonatal)
FI N₂O	0%-100% factory setting: 100%	0%-100% factory setting: 0%
ET N₂O	0%-100% factory setting: 100%	0%-100% factory setting: 0%
FI O₂	18%-100% factory setting: 100%	18%-100% factory setting: 18%
ET O₂	0%-100% factory setting: 100%	0%-100% factory setting: 5%

ADVANCED SETUP

ZERO GAS TYPE

"Scrubbed Air/N₂/O₂", "Room Air" and "100% O₂" for choice, the factory setting is "Room Air".

O₂ COMPENSATIONS

The anesthetic agents in the gas mixture need to be compensated in order to achieve its stated accuracy. The instrument settings for this parameter should be set when the O₂ sensor is unconnected. But when install the O₂ sensor, this function isn't available.

STANDBY MODE

When measurements are temporarily not needed, the monitor can switch the AAM from 'Operation Mode' into 'Standby Mode'. During standby, some internal components of the module are switched off, which increases the lifetime of the module. When measurements are needed again, the device must be switched back into 'Operation Mode'. The latter transition will usually take less than 30 seconds.

MAC (Minimum Alveolar Concentration) Calculation

The MAC value may be calculated and displayed by using end-tidal (ET) gas concentrations according to the following formula:

$$MAC = \frac{\%ET(AA1)}{X(AA1)} + \frac{\%ET(AA2)}{X(AA2)} + \frac{\%ET(N_2O)}{100}$$

X (AA): HAL=0.75%, ENF=1.7%, ISO=1.15%, SEV=0.25%, DES=6.0%

[NOTE]: The altitude, the patient's age, and other individual factors are not taken into account in the above described formula. ET gas concentrations for secondary agent (AA2) is only available for IRMAAX+/OR+ probes.

CALIBRATION

The gas module doesn't require calibration.

The gas module is calibrated once in the factory during production and this calibration is valid for the complete lifetime of the module. During operation, to compensate for drifts, the module will request a Zeroing Procedure in regular intervals. After a zeroing command from the host is made, the module will conduct the Zero Procedure automatically.

PATIENT INFORMATION ADMINISTRATION

- PATIENT BASIC INFORMATION SETUP
- ADD NEW PATIENT
- DELETE PATIENT

PATIENT BASIC INFORMATION SETUP

When you start the monitor, it will open a countdown window to remind you to set the patient information. If you choose YES, you can set patient information directly.

Also you can set the information by touching the patient ID area at the top left corner to open patient setup menu. The menu is as follows:

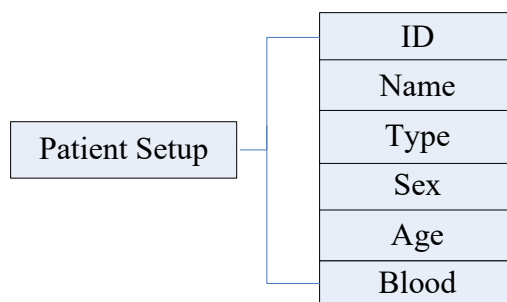

Figure 30: Tree Diagram for Patient Setup

ID

Set the ID number of patient. The ID number for each patient is different and unique.

[NOTE]: If you set the same ID as a previous patient, the measurement data recorded will be saved after the previous data for the patient with the same ID.

NAME

The input character range is: uppercase, A-Z, period (.) and whitespace character. Patient name only supports English characters. The user can input 9 characters at most.

SEX

Set the patient gender. The default setting is MALE.

BLOOD

Set the blood type of patient. It can be: **N/A**(unknown type), **A**, **B**, **O**, **AB**, **RH+**, **RH-** and so on, the default setting is **N/A**.

AGE

Set the age of patient. The range is 0 ~120, the default setting is **20**.

[NOTE]: The Patient Monitor displays physiological data and stores them in the trends as soon as a patient is connected. This allows you to monitor a patient that is not saved yet. However, it is recommended that you fully admit a patient so that you can clearly identify your patient, on recordings, reports and networking devices.

[NOTE]: Once the user chooses **YES** to exit from the Patient Information Setup, all information of patient will be refreshed and the trend data will be updated.

ADD NEW PATIENT

If you want to change other patient, you should input new patient information first. There are two ways to do this.

1. Touch the Patient ID area directly.
2. Open the "Pause" menu and then choose "Start new case".

DELETE PATIENT

The monitor can save eight groups of patient information for recall. You can delete previous patients in order to add new ones.

Open the "Recall" Menu, enter into the "Delete the patient" menu and select the patient you would like to remove.

TREND

- TREND OBSERVATION
- TIME SETUP
- MARK EVENT SETUP
- TREND TIME
- TREND GRAPH ANALYSIS
- TABULAR TREND ANALYSIS
- ALARM EVENT
- LAST WAVEFORM

TREND OBSERVATION

Monitoring system will save and trace the trend of the following parameters:
 Heart Rate (HR), Oxygen Saturation (SpO₂)
 Noninvasive Blood Pressure (SYS, DIA, Mean Blood Pressure)
 Temperature(Temp)
 Pulse Rate (PR)
 Respiration Rate (RR)
 End-tidal Carbon Dioxide (EtCO₂)
 Invasive Blood Pressure (IBP1, IBP2)
 EVENT

Press the **TREND** function button to open the graph below:

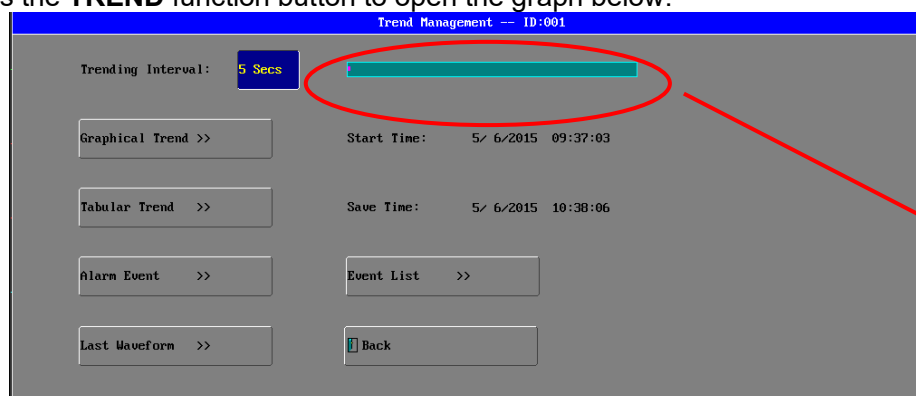

Data-recording Status Bar:
 The status bar is used to show the current data-recording length. The blue part means the maximum record length for the system, which is 60 hours. The Magenta part means the proportion of the current data-recording length.

TIME SETUP

In order to review data easily and intuitively, you should have set the monitor's time. Touch the time area at the top right corner to open Time Setup menu. The available settings are shown below:

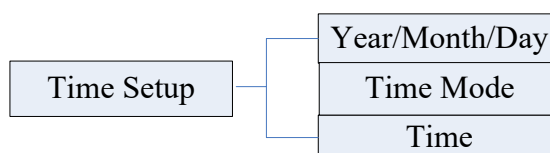

Figure 31: Tree Diagram for Time Setup

The value of year, month, day, hour and minute can be set. You can also set the Time Mode to 12h or 24h. system will amend the internal clock according to the new settings.

Once the system time has been updated, the trend data will be updated accordingly. On entering the master screen, please check whether the monitor time and the current time are consistent, if not, please correct them.

MARK EVENT SETUP

During the patient monitoring, events will occur that will influence the patient and cause the waveforms or parameters to change. In order to analyze the effect, you can mark the event for recall.

There are four types of events that you can define. You can freely define the implications of each type.

The menu is as shown below:

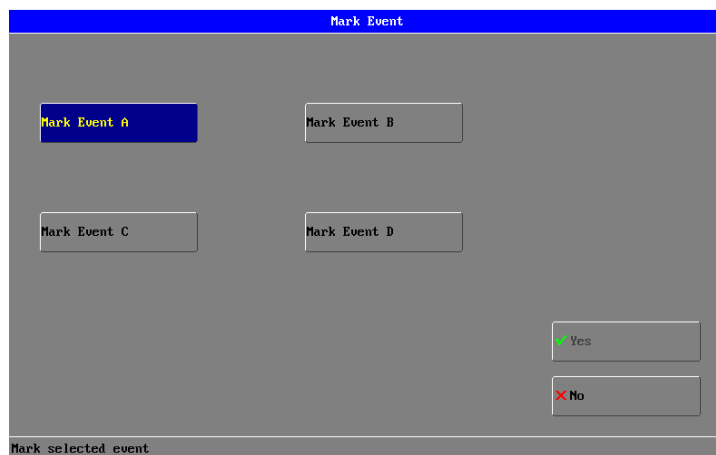

Figure 32: Window for Mark Event Setup

MARK EVENT

Choose the related event item you want from A, B, C and D. There is a **V** mark signal for the ones selected

Select **YES** to exit, and the event marked will be registered immediately upon the exit, or it will not become effective.

When an event occurs, all the measurement data at the event trigger time is stored.

The event can be recalled from the event list in the Trend section of the monitor. See chart below:

Event List										
NO.	Event	Time	NIBP	SPO2	HR	PR	RESP	T1	T2	ST
1	B	01/17 17:55:16	120/80	97	60	60	10	37.1	37.4	- 0.01
2	B	01/17 17:55:10	120/80	99	50	60	5	37.1	37.4	- 0.01
3	C	01/17 17:55:04	120/80	97	60	60	10	37.1	37.4	- 0.01
4	B	01/17 17:54:46	120/80	90	100	60	30	37.1	37.4	- 0.01
5	C	01/17 17:54:40	120/80	88	110	60	35	37.1	37.4	- 0.01
6	C	01/17 17:54:28	120/80	88	110	60	35	37.1	37.4	- 0.01
7	D	01/17 17:54:16	120/80	93	60	60	20	37.1	37.4	- 0.01
8	D	01/17 17:54:10	120/80	95	70	60	15	37.1	37.4	- 0.01
9	C	01/17 17:54:04	120/80	97	60	60	10	37.1	37.4	- 0.01
10	B	01/17 17:53:58	120/80	99	50	60	5	37.1	37.4	- 0.01
11	C	01/17 17:53:46	120/80	93	80	60	20	37.1	37.4	- 0.01
12	B	01/17 17:53:40	120/80	91	90	60	25	37.1	37.4	- 0.01
13	A	01/17 17:53:16	120/80	90	100	60	30	37.1	37.4	- 0.01
14	-	---	---	---	---	---	---	---	---	---
15	-	---	---	---	---	---	---	---	---	---
16	-	---	---	---	---	---	---	---	---	---

Figure 33: Window for Event List

IMPORTANCE OF EVENT MARKING

Event marking can classify the circumstances that influence parameters of interest being monitored for the patient, for example, medicine taking, injection and other treatment. These events, displayed on the trend graph and table, are very important to the parameter analysis.

TRENDING INTERVAL

Trending interval denotes how often the Graphic trend or the Tabular Trend displays the data.

There are ten items for trending interval choosing: 5s, 10s, 15s, 30s, 1 min, 5mins, 10mins, 15mins, 30mins and 60mins.

For instance, if 5s is chosen as the reference trending interval, then we can recall the trend data displayed in the trend every 5s.

TREND GRAPH ANALYSIS

TREND GRAPH ADMITTANCE

Press the “Trend Graph” button to open the Graphical Trend window.

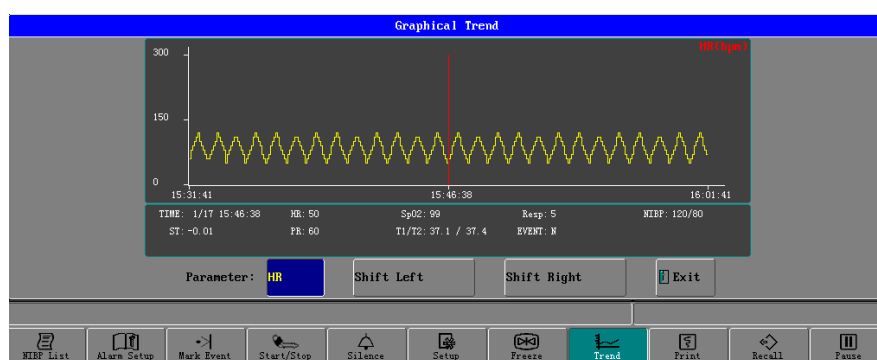

Figure 34: Window for Trend Graph

Each page displays the trend chart for one parameter, and the user can change the graph by choosing **PARAMETER**. The parameter order is as follows:

HR, SpO₂, RESP, NIBP, ST, PR, TEMP, inAgt, expAgt, inN₂O, EtCO₂, IBP1, IBP2.

The newest data is on the right side of the graph, time is displayed on the bottom of the graph on a 24 hour scale, and the upper and lower limits of the parameter are displayed on the left side of graph.

CURSOR BAR

The cursor bar is the red vertical line on the trend graph. The parameters' values in the graph are obtained at the time that the red vertical line indicates.

Press the “Shift Left” or “Shift Right” button. You will move the red cursor bar left or right until it is at the appropriate position.

TABULAR TREND ANALYSIS

TREND TABLE ADMITTANCE

Press the “Tabular Trend” button to open the Tabular Trend window. The window will display in the waveform area on the screen.

Sixteen groups of parameters are listed on every page with three hundred groups in total. These data will be listed in order from newest to oldest. Time is displayed in 24-hour format. The parameter name is displayed on the top of chart and the invalid data will not display.

BASIC TABULAR TREND

Tabular Trend										
NO.	Time	NIBP	SP02	HR	PR	RESP	T1	T2	ST	Event
1	01/17 18:09:48	120/80	86	120	60	40	37.1	37.4	- 0.01	N
2	01/17 18:09:42	120/80	88	110	60	35	37.1	37.4	- 0.01	N
3	01/17 18:09:36	120/80	91	90	60	25	37.1	37.4	- 0.01	N
4	01/17 18:09:30	120/80	93	80	60	20	37.1	37.4	- 0.01	N
5	01/17 18:09:24	120/80	95	70	60	15	37.1	37.4	- 0.01	N
6	01/17 18:09:18	120/80	97	60	60	10	37.1	37.4	- 0.01	N
7	01/17 18:09:12	120/80	99	50	60	5	37.1	37.4	- 0.01	N
8	01/17 18:09:06	120/80	95	70	60	15	37.1	37.4	- 0.01	N
9	01/17 18:09:00	120/80	93	80	60	20	37.1	37.4	- 0.01	N
10	01/17 18:08:54	120/80	91	90	60	25	37.1	37.4	- 0.01	N
11	01/17 18:08:48	120/80	90	100	60	30	37.1	37.4	- 0.01	N
12	01/17 18:08:42	120/80	88	110	60	35	37.1	37.4	- 0.01	N
13	01/17 18:08:36	120/80	88	110	60	35	37.1	37.4	- 0.01	N
14	01/17 18:08:30	120/80	90	100	60	30	37.1	37.4	- 0.01	N
15	01/17 18:08:24	120/80	91	90	60	25	37.1	37.4	- 0.01	N
16	01/17 18:08:18	120/80	93	80	60	20	37.1	37.4	- 0.01	N

Figure 35: Window for Basic Parameters Tabular Trend

IBP TABULAR TREND

Tabular Trend				
NO.	Time	IBP1	IBP2	Event
17	01/17 17:17:44	126/86	32/18	N
18	01/17 17:17:38	126/86	32/18	N
19	01/17 17:17:32	126/86	32/18	N
20	01/17 17:17:26	126/86	32/18	N
21	01/17 17:17:20	126/86	32/18	N
22	01/17 17:17:14	126/86	32/18	N
23	01/17 17:17:08	126/86	32/18	N
24	01/17 17:17:02	126/86	32/18	N
25	01/17 17:16:56	126/86	32/18	N
26	01/17 17:16:50	126/86	32/18	N
27	01/17 17:16:44	126/86	32/18	N
28	01/17 17:16:38	126/86	32/18	N
29	01/17 17:16:32	126/86	32/18	N
30	01/17 17:16:26	126/86	32/18	N
31	01/17 17:16:20	126/86	32/18	N
32	01/17 17:16:14	126/86	32/18	N

Figure 36: Window for IBP Tabular Trend

MOVING THE TREND TABLE

Press the “PageUp”, “PageDown”, “Print”, or “Clear” buttons to complete the corresponding operation.

If you choose the “Clear” button, all data saved in the trend will be deleted.

TRANSFERRING TRENDS VIA RS-232

The entire trend memory can be transferred to an external computer via the RS-232 interface. Refer to the RS-232 INTERFACE section for details.

ALARM EVENT

In this window, you can recall alarm information. It includes the parameter’s waveform and the values exceed the limits.

In this window you can select the alarm parameter (10 parameters), alarm waveform (12 waveforms) and alarm times (8 times).



Figure 37: Window for Alarm Event Review

LAST WAVEFORM

Press “**Last Waveform**” button to open the last waveform review window, which appears as shown below:

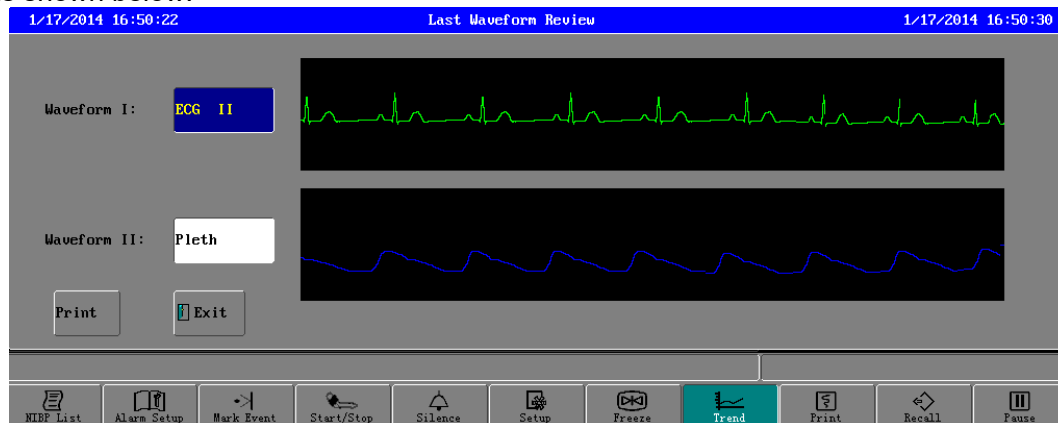

Figure 38: Window for Last Waveform Review

When there are waveforms to display for demonstration or real-time measurement, the system only saves data for the last 16 seconds and displays two selectable waveforms. The time of occurrence for most recent waveforms will display on the title bar in the window.

CALCULATION

- INTRODUCTION
- DRUG CALCULATION
- HEMODYNAMIC CALCULATION

INTRODUCTION

The calculation feature is available with your patient monitor. The calculated values, which are not directly measured, are computed based on the values you enter.

OMNI II Patient Monitor can perform two main calculations: Drug calculation and Hemodynamic calculation.

[NOTE]: The calculation feature is independent of other monitoring functions and can therefore be used for patients being monitored by other monitors. Any operation in a calculation window does not affect the monitoring for patients.

DRUG CALCULATION

HOW TO OPERATE

1. Select "System Setup" --->"Drug Calculation" menu. The interface appears as shown in Figure 39:
2. Select the appropriate settings. The drug calculation program has a library of commonly used drugs, as well as drug to drug E, which represent drugs not specified in the library.

The drugs are as follows: Aminophylline, Dobutamine, Dopamine, Epinephrine, Heparin, Isuprel, Lidocaine, Nipride, Nitroglycerin, Pitocin, and drugs A, B, C, D, E.

The user must enter values following the doctor's instructions, and then only the calculated value can be used.

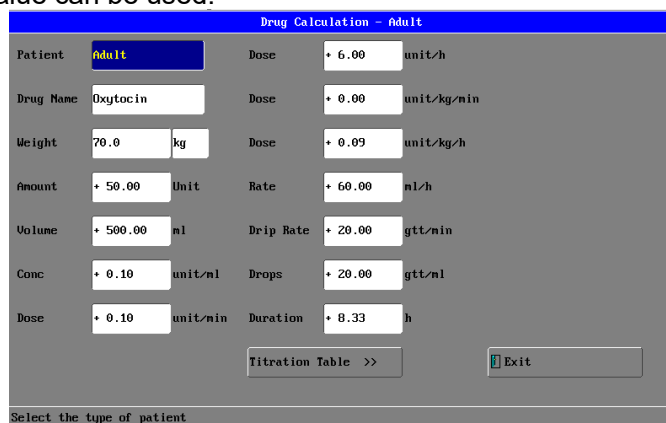

Figure 39: Window for Drug Calculation

DRUG UNIT

Each drug has its fixed unit or unit series. Among a unit series, one unit may change to another automatically depending on the entered value.

The units for each drug are as follows:

- Drug A, B, C, Aminophylline, Dobutamin, Dopamine, Epinephrine, Isuprel, Lidocaine, Nipride and Nitroglycerin use the following unit series: g, mg and mcg.
- Drug D, Heparin and Pitocin use the following unit series: unit, KU (kilo units) and MU (million units).
- Drug E uses mEq (milli-equivalents).

You must select the proper drug name (A, B, C, D or E) according to the units when you define a drug not listed the library.

TITRATION TABLE

Select "Titration Table" in the "Drug Calculation" window after the drug calculation is finished.

In the titration table, when you select "Reference", "Interval", "Dose Type", the titrated value will change accordingly.

Select "Print" to print out the currently displayed titrated values by the printer.

HEMODYNAMIC CALCULATION

Hemodynamic, meaning literally "Blood flow, motion and equilibrium under the action of external forces", pertains to blood flow or circulation. It explains the physical laws that govern the flow of blood in the blood vessels.

Hemodynamic calculations have an important meaning for clinical guidance.

HOW TO OPERATE

1. Select "System Setup" --->"Hemodynamic Cal" menu. The interface appears as shown in Figure 40:
2. Confirm you have input correct values.
3. Select the "Calculation" button. The system performs a calculation per the current settings and displays the calculated values.
 - If a calculated value is outside the desired range, its background will be highlighted in yellow.
 - You can press the "Reference Range" button to view the normal range in the unit field.
 - Invalid values are displayed as "---".
4. Press the "Print" button; the currently displayed calculations will be printed out by the printer.
5. Review previously performed calculations by selecting "Calculation Review". Review the input data by selecting "Check Input".

Figure 40: Window for Hemodynamic Calculation

INPUT PARAMETERS

Abbreviation	Unit	Full Spelling
C.O.	l/min	Cardiac Output
HR	bpm	Heart Rate
PAWP	mmHg	Pulmonary Artery Wedge Pressure
ART Mean	mmHg	Artery Mean Pressure
PA Mean	mmHg	Pulmonary Artery Mean Pressure
CVP	mmHg	Central Venous Pressure
EDV	ml	End-Diastolic Volume
Height	cm	Height
Weight	kg	Weight

OUTPUT PARAMETERS

Abbreviation	Unit	Full Spelling
C.I.	l/min/m ²	Cardiac Index
BSA	m ²	Body Surface Area
SV	ml	Stroke Volume
SVI	ml/m ²	Stroke Index
SVR	DS/cm ⁵	Systemic Vascular Resistance
SVRI	DS · m ² /cm ⁵	Systemic Vascular Resistance Index
PVR	DS/cm ⁵	Pulmonary Vascular Resistance
PVRI	DS · m ² /cm ⁵	Pulmonary Vascular Resistance Index
LCW	Kg · m	Left Cardiac Work
LCWI	Kg · m/m ²	Left Cardiac Work Index
LVS	g · m	Left Ventricular Stroke Work
LVSWI	g · m/m ²	Left Ventricular Stroke Work Index
RCW	Kg · m	Right Cardiac Work
RCWI	Kg · m/m ²	Right Cardiac Work Index
RVS	g · m	Right Ventricular Stroke Work
RVSWI	g · m/m ²	Right Ventricular Stroke Work Index
EF	%	Ejection Fraction

RECALL DATA

- RECALL DATA STORAGE
- RECALL DATA DISPLAYS
- RECALL OPERATION DESCRIPTIONS

RECALL DATA STORAGE

Recall Data in graphical or tabular format can be displayed on the screen, transferred to a computer for analysis via the RS232 interface, or printed if a printer is installed.

The recall data for all parameters is the average of a 5-second sample of the data. Sixty (60) hours of recall data is stored in a nonvolatile memory, and remain in storage when the monitor is in Standby.

A new print of recall data is started each time the monitor is turned on. A recall data record is defined as the data from one Power On event to the Standby power event. A date/time annotation is included at the start of each new print (for up to eight patients) and the print can be collated with the patient. Once the recall memory has stored 60 hours of data, the oldest recall data will be overwritten by new data.

RECALL DATA DISPLAY

The Recall data are displayed in graphical or tabular format. The recall information in graphical format for a selected parameter is shown as a graph connecting each of the points representing the stored 5-second average.

The information stored for each recall episode can include:

- Numeric vital signs for all the measurements monitored
- Waveforms for up to 12 measurements of alarm events for your choice

You can navigate through the recall database to view events retrospectively, and you can document recalls on a recording or report marked with the patient name, patient ID, the data and time.

RECALL OPERATION DESCRIPTION

1. You should enter the ID and name of a patient first for recall

After you power on the monitor, will be a pop up on the screen to remind you to the patient's ID:

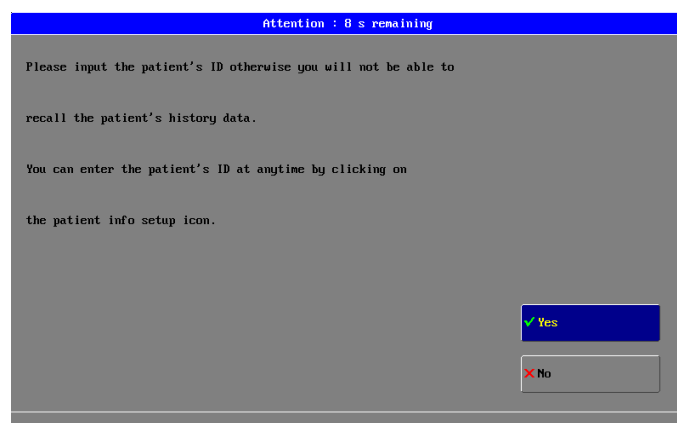

Figure 41: Window for Indication Information

The above window will be automatically closed after 10 seconds.

2. Press the "Recall" soft-key to open the recall function for up to 8 patients

3. Select the patient's ID for recall

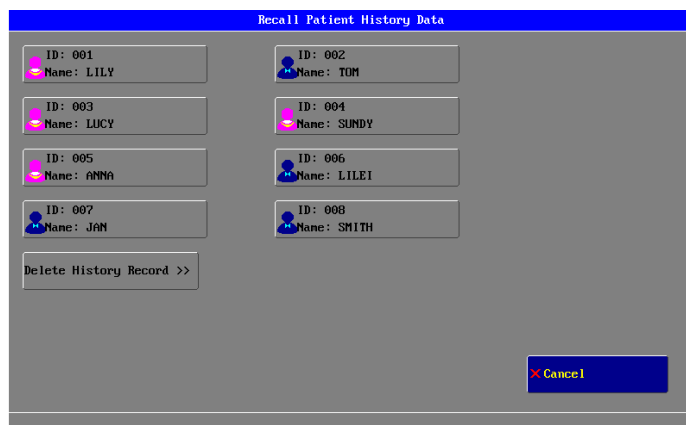

Figure 42: Window for Recall Patient

Select one ID for a patient, and then enter the **Trend Management** window with Patient ID which appears as below:

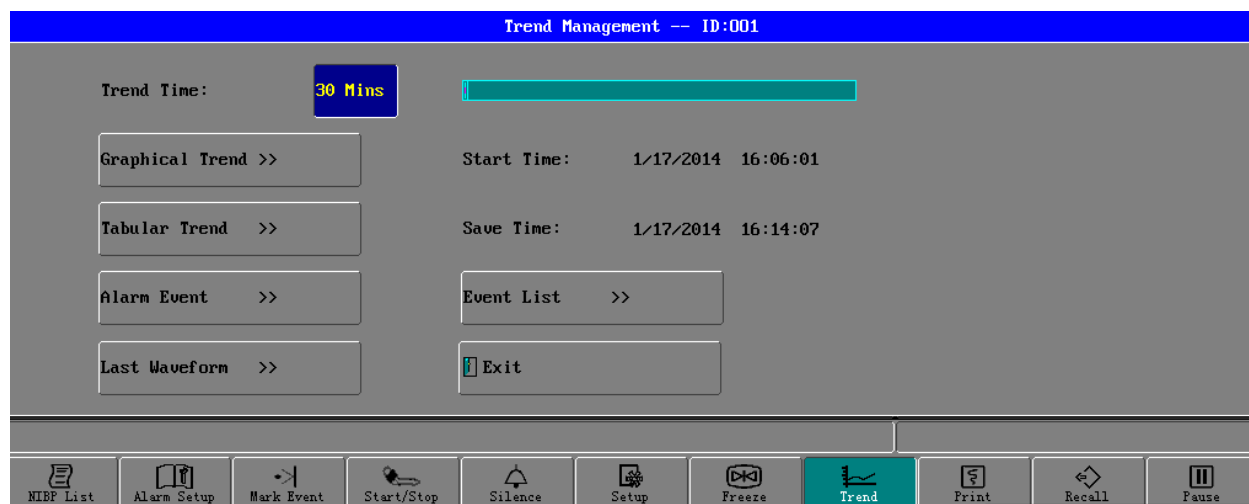

Figure 43: Window for Trend Management with ID

[NOTE]

- ◆ This trend management default window is for a patient who has no ID number.
- ◆ For an introduction to trend data please refer to the chapter TREND.

RS-232 INTERFACE

- OVERVIEW
- CABLE CONNECTION
- EXPORTING TREND DATA

OVERVIEW

Patient data can be obtained through the RS-232 I/O connector on the rear panel of the monitor by connecting it to an attached PC.

CAUTION: DO NOT download patient data when the monitor is monitoring a patient. This may cause the monitor to lock up.

CABLE CONNECTION

The 9-pin connector mounted on the rear panel provides an access port for a serial (RS-232) interface to a suitably configured personal computer. Its pin layout is as follows:

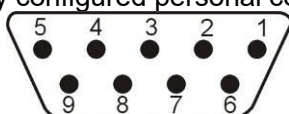

RS-232 Serial Interface Connections:

Pin #	Signal	Definition
1	not used	
2	TXD	Transmit Data
3	RXD	Received Data
4	not used	
5	GND	Signal Ground
6	not used	
7	not used	
8	not used	
9	+5V	Power Supply

EXPORTING TREND DATA

In order to download trend data from the OMNI II, communication software should be installed in the external computer. The transfer protocol should be set as follows:

Baud Rate: 57600

Data Bits: 8

Start Bit: 1

Stop Bit: 1

Odd Parity: 1

Connect the OMNI II to the serial port of the computer using a cable. Start the communication program on the computer and export trend data from the OMNI II.

PRINTER (OPTIONAL)

- PRINTER SETUP
- PRINT REAL-TIME WAVEFORM
- PRINT TABULAR TREND
- GRID OUTPUT
- PRINT ALARM EVENT
- PRINT EVENT LIST
- PRINT EXPLANATION
- WAVEFORM PRINT EXPLARION

PRINTER SETUP

Please refer to chapter SYSTEM SETUP for details.

[NOTE]: The monitor uses a thermal printer, which must use thermal printer paper (the specification is 48 mm on width).

PRINT REAL-TIME WAVEFORM

Press the “Print” soft-key. The statement “Printing Started” should appear on the bottom of the screen, indicating that the print process has begun. If you want to terminate the print job during the printing process, just press the “Print” soft-key again. The printer will stop immediately and the statement “Printing Stopped” will appear on the bottom of screen.

The monitor can print a burst of two or three waveforms and the waveforms data from the previous 8 seconds will be printed.

The print contents also include Patient Name, Hospital name, Print Time, HR, ST, RESP, SpO₂, NIBP (SYS, DIA,) T1, T2, EtCO₂, IBP1, IBP2 and so on. See graph below:

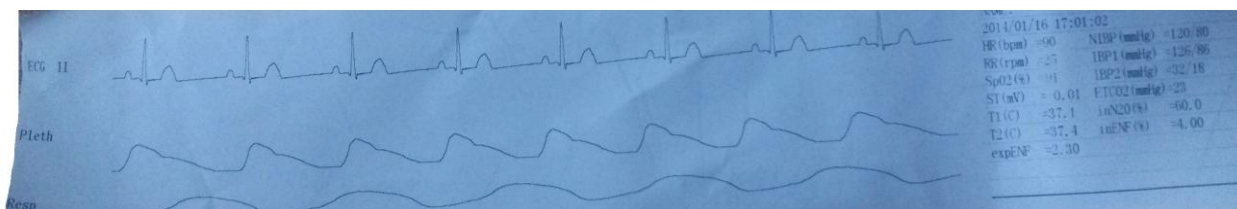

Figure 44: Real-time Waveform Print

PRINT TABULAR TREND

You can print not only the basic parameter trend table but also other tables such as IBP Tabular, EtCO₂ Tabular and so on.

[NOTE]: Printing a table is enabled when the relevant module is opened.

Time	17:08:13	17:08:07	17:08:01	17:07:06	17:07:00	17:06:54	17:06:48	17:06:42
NIBP (mmHg)	120/80	120/80	120/80	120/80	120/80	120/80	120/80	120/80
SpO2 (%)	88	88	90	88	86	88	90	91
HR (bpm)	110	110	100	110	120	110	100	90
PR (bpm)	60	60	60	60	60	60	60	60
Resp (rpm)	35	35	30	35	40	35	30	25
T1, T2 (C)	37.1/37.4	37.1/37.4	37.1/37.4	37.1/37.4	37.1/37.4	37.1/37.4	37.1/37.4	37.1/37.4
ST (mV)	-0.01	-0.01	-0.01	-0.01	-0.01	-0.01	-0.01	-0.01

NAME:
2014/01/16 17:13:18
Trend Table

Figure 45: Basic Tabular Trend Print

GRID OUTPUT

For printer paper without a grid, you can set the grid form in order to observe the waveform easily. You can set the grid by following the instructions in the chapter SYSTEM SETUP.

When Grid Output is set to ON (default setting is OFF), then the parameters will be printed in the grid format.

PRINT ALARM EVENT

When a parameter value violates the range limits, you can recheck the alarm trend by pressing the "Trend" soft-key and choosing "Alarm Event". In the Alarm trend menu, you can choose the "Print" item to record the alarm information.

The printout for an alarm report includes Patient Name, Alarm Message, Alarm Happened Time, waveform if the parameter has one and the data associated with the parameter.

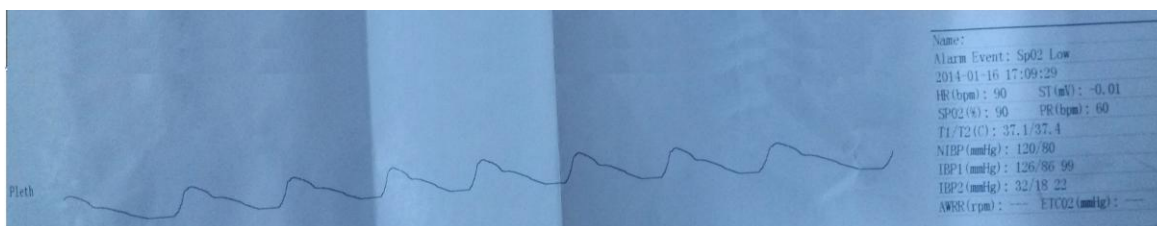

Figure 46: Alarm Event Print

If the alarm print setting is turned ON, it will print the waveform over a period of 8 seconds (the 4 seconds before and after the alarm) when the alarm is triggered.

[NOTE]: "-----" means invalid parameter.

PRINT EVENT LIST

Print out the event list for review.

Event	D	B	D	D	D	A	-	-	NAME:
Time	16:10:45	16:10:39	16:10:27	16:10:21	16:10:15	16:10:09	00:00:00	00:00:00	2014/01/20 16:11:02
NIBP (mmHg)	120/80	120/80	120/80	120/80	120/80	120/80	---/---	---/---	Event List
SpO2 (%)	97	97	93	91	90	88	---	---	
HR (bpm)	60	60	80	90	100	120	---	---	
PR (bpm)	60	60	60	60	60	60	---	---	
Resp (rpm)	10	10	20	25	30	40	---	---	
T1/T2(C)	37.1/37.4	37.1/37.4	37.1/37.4	37.1/37.4	37.1/37.4	37.1/37.4	---/---	---/---	
ST (mV)	-0.01	-0.01	-0.01	-0.01	-0.01	-0.01	---	---	

Figure 47: Event List Print

PRINT EXPLANATION

INSERTING PAPER

Press the button on the catch of the printer, open the catch, take the old paper roll out and insert a new one into the paper cassette. Make sure that the paper can spin freely. Pull a small length of paper out of the catch from the lower end of the roll (If it is the upper end, then paper reel was installed conversely), close the catch, and make sure that the paper is just in the groove. Otherwise, the paper advance will not be print properly.

ATTENTIONS

- The printer cannot print continuously for more than 2 minutes.
- DO NOT press the print button if there is no paper because the printer head will be damaged.
- Only thermal printer paper can be used.
- If there is too much dust, use a sponge lightly moistened with alcohol to clean the parts of the printer.

MESSAGES

Message	Meaning
Start printing. . .	Printing process has begun.
Break printing!	The print button has been pressed again during the printing process. Pressing the button again will restart it.
Printer Door Open	Printer door has been opened
Printer Door Close	Printer door has been closed
Printer Paper Ok	Indicates that printer paper has been installed properly
Printer No Paper	Printer paper has been used up
Printer Unlink!	Printer has not been connected to monitor.
Print Not Ready	Printer has not been connected well

WAVEFORM PRINT EXPLANATION

Paper Advance Speed: 25mm/s

Scale Specification: ×0.5 expresses 1mV/3.25mm
 ×1 expresses 1mV/6.5mm
 ×2 expresses 1mV/13mm

BATTERY OPERATION

INTRODUCTION

OMNI II Patient Monitor is designed to operate on one rechargeable Lithium ion battery whenever AC power is interrupted. The battery is charged whenever the patient monitor is connected to an AC power source regardless of whether or not the patient monitor is currently on.

A new, fully charged battery will provide about 2 hours of monitoring time under the following conditions: no audible alarms are sounded, no analog or serial output devices are attached, and no backlight is used.

The lifetime of the battery is about 300 charge and discharge cycles. Life expectancy of a battery depends on how frequent and how long it is used. For a properly maintained and stored lithium-ion battery, its life expectancy is about 3 years. For more aggressive use models, life expectancy can be less. We recommend replacing lithium-ion batteries every 3 years.

When the battery is being charged, the DC LED will be ON; a flashing icon will be displayed in the upper right quarter of the screen to indicate the status of recharging. Once fully charged, the symbol will stop flashing. When the monitor is powered by the battery, the DC LED will flicker and an icon representing the current capacity of the battery will be displayed in the upper-right corner of the screen.

When operating on battery power, the monitor will sound an alarm and shut off automatically when the battery's capacity is low. When the battery's capacity is lower than 25 % of its total capacity, the alarm will sound, and a message of "Battery Power Low" will be displayed in the message area in the top of screen. The battery icon will change to empty.

Connecting the monitor to AC power when this alarm sounds will begin recharging the battery while still operating. If you keep operating on the battery, the monitor will shut off automatically upon exhaustion of the battery.

[NOTE]: Whenever the monitor is connected to AC power, the battery is being charged. Therefore, it is recommended that the monitor remain connected to AC power when not in use. This will keep the battery at full charge as often as possible.

CONDITIONING A BATTERY

A battery needs at least two conditioning cycles when it is put into use for the first time. A battery conditioning cycle is one complete, uninterrupted charge of the battery, followed by an uninterrupted discharge of the battery. Batteries should be conditioned regularly to maintain their useful life.

[NOTE]: As the battery is used and recharged over a period of time, the period of time between the onset of the low battery alarm and the instrument shut-off may become shorter.

[CAUTION]: If the OMNI II is to be stored for a period of 3 months or longer, notify service personnel to remove the battery from the monitor prior to storage. Recharge the battery when it has not been charged for 3 or more months.

BATTERY RECYCLE

When a battery has visual signs of damage or no longer holds a charge, it should be replaced. Remove the old battery from the Patient Monitor and recycle it properly. Follow local laws when disposing the battery.

[WARNING]: DO NOT disassemble batteries or put them into fire or cause them to short circuit. They may ignite, explode, or leak, causing personal injury.

DISPOSAL OF DEVICE COMPONENTS

Follow local governing ordinances and recycling instructions when disposing or recycling device components, including batteries.

PERIODIC SAFETY CHECKS

It is recommended that the following checks be performed every 24 months.

- Inspect the equipment for mechanical and functional damage.
- Inspect the safety labels for legibility.

[WARNING]: DO NOT spray, pour, or spill liquid on OMNI II, its accessories, connectors, switches, or openings in the chassis. DO NOT submerge the OMNI II or its accessories in liquid or clean it with caustic or abrasive cleaners.

The Life expectancy of the OMNI II Patient Monitor depends on how frequent and how long it is used. For a properly maintained, its life expectancy is 5 years. For more aggressive use models, life expectancy can be less. We recommend replacing the monitor every 5 years.

CLEANING

To clean the OMNI II, dampen a cloth with a commercial, nonabrasive cleaner and wipe the exterior surfaces lightly. Do not allow any liquid to come in contact with the power connector or switches. Do not allow any liquids to penetrate connectors or openings in the instrument. For cables, sensors, and cuffs, follow the cleaning instructions in the instruction manuals for these accessories.

SPECIFICATIONS

SAFETY	
Meet the requirement of EN60601 series, CE marking according to MDD93/42/EEC	
Equipment not suitable for use in the presence of a flammable anesthetic mixture with air or with oxygen or nitrous oxide	
Type of Protection:	Class I (on AC power) Internally powered (on battery power)
Degree of Protection:	Type BF, defibrillation-proof CF - Applied part
Sterilization or Disinfection methods:	70% isopropyl alcohol solution or a nonstaining disinfectant.
Operation Mode:	Continuous Operation
Protection Against Ingress of Liquid's:	IPX1
APPLICATION	
Neonatal, pediatric and adult patients	
Physical Dimensions & Weight	
Base Unit:	555×335×235 mm
Weight:	4.5 kgs
PERFORMANCE SPECIFICATIONS	
Display:	12.1" color TFT
Resolution:	800 x R.G.B. x 600
Trace:	3, 6, 8 or 12 waveforms
Waveforms:	ECG(I, II, III, aVR, aVL, aVF, V1-V6), Pleth, Resp, IBP1, IBP2, ETCO2, AG
Indicator:	Alarm indicator Power indicator QRS beep and alarm sound
Trend time:	From 30 minutes to 120 hours
ECG	
Input:	5/3/12-lead ECG cable and standard AAMI line for connection
Standards:	ANSI/AAMI EC13 EN60601-2-27 / IEC60601-2-27
Lead Choice:	3-Lead: I, II, III 5-Lead: I, II, III, aVR, aVL, aVF, V 12-Lead: I, II, III, aVR, aVL, aVF, V1~V6
Gain Choice:	×0.25, ×0.5, ×1.0, ×2.0, 4.0
ECG Waveforms:	12 channels
CMRR (Common Mode Rejection Ratio):	≥89 dB
Frequency Characteristic:	0.67~40 Hz (+3dB attenuation)
Differential Input Impedance:	>5 MΩ
Sweep Speed:	12.5, 25 and 50 mm/s
HR Display Range:	30~300 bpm
Accuracy:	±1bpm or ±1%, whichever is greater
Alarm Limit:	Upper Limit: 80~400 bpm Lower Limit: 12~150 bpm
Electrode Offset Potential Tolerance:	± 300 mV
Input Signal Range:	±5 mV (peak-to-peak value)
Base Line Recovery Time:	<5 s after defibrillation
Bandwidth(-3dB):	Diagnostic Mode: 0.05 Hz~130 Hz

	Monitor Mode : 0.5 Hz~40 Hz Surgical Mode : 1 Hz~20 Hz
Recovery:	<8 s
Pace Pulse Markers:	Pace pulses meeting the following conditions are labeled with a PACE marker: Signal Amplitude: ± 10 mV~ ± 700 mV Pulse Width: 0.1 ms~2 ms Signal Rising and Falling Time: 10 μ s~100 μ s
Pace Pulse Rejection:	When tested in accordance with the ANSI/AAMI EC13-2002: Sections 4.1.4.1 and 4.1.4.3, the heart rate meter rejects all pulses meeting the following conditions. Signal Amplitude: ± 2 mV~ ± 700 mV Pulse Width: 0.1ms~2 ms Signal Rising and Falling Time: 10 μ s~100 μ s
ESU Protection:	Cut mode: 300 W Coagulate mode: 100 W Recovery time: ≤ 10 s In compliance with the requirements in clause 4.2.9.14 of ANSI/AAMI EC 13:2002
ST Measurement Range:	-2.0~2.0 mV
ST Accuracy:	-0.8 ~ 0.8 mV: ± 0.02 mV or $\pm 10\%$, whichever is greater. Beyond this range: Not specified
Tall T-wave Rejection Capability	When the test is performed based on part 4.1.2.1 c) of ANSI/AAMI EC13-2002, the heart rate meter will reject all 100ms QRS complexes with less than 1.0mV of amplitude, and T waves with T-wave interval of 180 ms and those with Q-T interval of 350 ms.
RESP	
Measure Method:	RA-LL Impedance
Lead:	Lead II
Respiration Excitation Waveform:	<300 μ A, sinusoid, 62.5 kHz ($\pm 10\%$)
Range:	0~120 rpm
Accuracy:	± 3 rpm
Alarm Limit:	Upper Limit: 8~120 rpm Lower Limit: 6~100 rpm
Sweep Speed:	6.25, 12.5 and 25 mm/s
Gain Choice:	$\times 0.25$, $\times 0.5$, $\times 1.0$, $\times 2.0$
Respiration Impedance Range:	0.3 Ω ~5 Ω
Baseline Impedance Range:	200 Ω ~2500 Ω (using an ECG cable with 1k Ω resistance)
NIBP	
Measurement Technology:	Automatic Oscillating Measurement
Cuff Inflating:	<30 s (0~300 mmHg, Standard Adult Cuff)
Max Measuring Time:	Adult, pediatric: 180 s Neonate: 90 s
Mode:	Manual, Auto, STAT, Average
Measuring Interval In AUTO Mode:	2 minutes~4 hours
Pulse Rate Range:	30 bpm~300 bpm

Pulse Rate Accuracy:	<= 2 bpm (PR<=100 bpm) <= 2% (PR>100 bpm)	
Measurement Range:	Adult/Pediatric Mode SYS 40~250 (mmHg) DIA 15~200 (mmHg) Neonatal Mode SYS 40~135 (mmHg) DIA 15~100 (mmHg)	
Resolution:	1mmHg	
Pressure Accuracy:	Maximum Mean Error: ±5mmHg Maximum Standard Deviation: 8mmHg	
Overpressure Protection:	Adult/Pediatric Mode : 297 (mmHg) Neonatal Mode : 147 (mmHg)	
Alarm Limit:	Adult/Pediatric Mode SYS 30~270 (mmHg) DIA 10~215 (mmHg) Neonatal Mode SYS 30~240 (mmHg) DIA 10~180 (mmHg)	
SpO2		
Standard:	ISO 9919	
ASpO2:	Anti-motion SpO2	
Measurement Technology:	Light absorption method	
SpO ₂ Probe:	Red Light LED Wavelength: 660±5 nm Infrared Light LED Wavelength: 940±10 nm	
Option Type:	Infinium, Masimo, Nellcor (See each module's relative technical specifications)	
Refreshing Rate:	1 s	
SpO ₂ Alarm Limit:	Upper Limit : 50~100 %, Lower Limit : 50~100 %	
PR Alarm Limit:	Upper Limit : 70~239 bpm, Lower Limit : 20~150 bpm	
InfiniumSpO2		
SpO ₂ Measurement Range:	0~100 %	
SpO ₂ Resolution:	1 %	
SpO ₂ Accuracy:	70~100 %: ±2 % (non-motion) 70~100 %: ±3 % (motion) 0~69 % : Undefined	
PR Measurement Range:	30~250 bpm	
PR Resolution:	1 bpm	
PR Accuracy:	±2 bpm(non-motion) ±3 bpm (motion)	
Masimo SpO2		
Measurement Range:	SpO ₂ : 1~100 %	
	PR: 25~240 bpm	
	Perfusion: 0.02~20 %	
SpO ₂ Accuracy: (non-motion) ¹	Adult Pediatric	70~100 %: ±2 % 0~69% : unspecified
	Neonate	70~100 %: ±3 % 0~69 % : unspecified
SpO ₂ Accuracy: (motion) ^{2,3}	Adult Pediatric	70~100 %: ±3 % 0~69% : unspecified

	Neonate	70~100 %: ± 3 % 0~69 % : unspecified
PR Accuracy: (non-motion) ¹	Adult Pediatric Neonate	25~240 bpm: ±3 bpm
PR Accuracy: (motion) ^{2,3}	Adult Pediatric Neonate	25~240 bpm: ±5 bpm
SpO ₂ Resolution:	1 %	
PR Resolution:	1 bpm	
Low Perfusion Performance ⁴ :	>0.02 % Pulse Amplitude and % Transmission >5 %	SpO ₂ : ±2 % PR: ±3 bpm
Modes:	Averaging mode: 2,4,8,10,12,14 and 16 s Sensitivity: Normal, APOD and Maximum	
<p>1. The OMNI II with Masimo specified sensor has been validated for no motion accuracy in human blood studies on healthy adult volunteers in induced hypoxia studies in the range of 70-100 % SpO₂ against a laboratory co-oximeter and ECG monitor. This variation equals plus or minus one standard deviation. Plus or minus one standard deviation encompasses 68 % of the population.</p>		
<p>2. The OMNI II with Masimo specified sensor has been validated for motion accuracy in human blood studies on healthy adult volunteers in induced hypoxia studies while performing rubbing and tapping motions at 2 to 4 Hz at an amplitude of 1 to 2 cm and a non-repetitive motion between 1 to 5 Hz at an amplitude of 2 to 3 cm in induced hypoxia studies in the range of 70 – 100 % SpO₂ against a laboratory co-oximeter and ECG monitor. This variation equals plus or minus one standard deviation. Plus or minus one standard deviation encompasses 68 % of the population.</p>		
<p>3. The OMNI II with Masimo specified sensor has been validated for motion and no motion accuracy in human blood studies on healthy adult volunteers in induced hypoxia studies while performing rubbing and tapping motions at 2 to 4 Hz at an amplitude of 1 to 2 cm and a non-repetitive motion between 1 to 5 Hz at an amplitude of 2 to 3 cm in induced hypoxia studies in the range of 70 – 100 % SpO₂ against a laboratory co-oximeter and ECG monitor. 1% has been added to the results to account for the effects of fetal hemoglobin. This variation equals plus or minus one standard deviation. Plus or minus one standard deviation encompasses 68% of the population.</p>		
<p>4. The OMNI II with Masimo specified sensor has been validated for low perfusion accuracy in bench top testing against a Biotek Index 2 simulator and Masimo's simulator with signal strengths of greater than 0.02 % and a % transmission of greater than 5 % for saturations ranging from 70 to 100 %. This variation equals plus or minus one standard deviation. Plus or minus one standard deviation encompasses 68 % of the population.</p>		
Nellcor SpO₂		
Measurement Range:	SpO ₂ : 0~100 % PR: 20~300 bpm	
SpO ₂ Accuracy:	70~100 %: ±2 % (Adult/ Pediatric) 70~100 %: ±3 % (Neonatal) 0~69 % : Undefined	
PR Accuracy:	20~250 bpm: ±3 bpm 251~300 bpm: Undefined	
TEMP		
Standards:	EN 12470-4	
Measurement Range:	Thermal Resistance	
Scale:	Selectable °C or °F	
Channel:	2 channels	
Range:	T1 and T2 : 25°C~50°C/77 °F~122 °F Delta T: 0°C~5.5°C/0°F~9.9 °F	
Accuracy:	±0.2°C(25.0°C~34.9°C) / (77°F~94.8°F) ±0.1°C(35.0°C~39.9°C) / (95°F~103.8°F)	

	$\pm 0.2^{\circ}\text{C} (40.0^{\circ}\text{C} \sim 44.9^{\circ}\text{C}) / (104^{\circ}\text{F} \sim 112.8^{\circ}\text{F})$ $\pm 0.3^{\circ}\text{C} (45.0^{\circ}\text{C} \sim 50.0^{\circ}\text{C}) / (113^{\circ}\text{F} \sim 122^{\circ}\text{F})$		
Display Resolution:	0.1°C (0.2°F)		
Alarm Limit:	Upper Limit: 10°C ~ 50°C / 50°F ~ 122°F Lower Limit: 10°C ~ 50°C / 50°F ~ 122°F		
IBP			
Standards:	EN 60601-2-34/IEC 60601-2-34		
Measurement Technology:	Direct Invasive Measurement		
Measurement Range:	-10 ~ 300 mmHg		
Resolution:	1 mmHg		
Accuracy:	±1 mmHg or ±2 %, whichever is greater		
Refresh Rate:	1 s		
Channel:	2 channels		
Alarm Limit:	LABEL	HI(mmHg)	LO(mmHg)
	ART(SYS,DIA)	0 ~ 300	0 ~ 300
	PA(SYS,DIA)	-10 ~ 120	-10 ~ 120
	CVP,LAP,RAP,ICP(MAP)	-10 ~ 140	-10 ~ 40
Zero Range:	±120 mmHg		
Excitation:	5V DC ±2%		
Pressure Transducer:	Sensitivity, 5µV/V/mmHg		
Impedance Range:	300 ~ 3000 Ω		
Transducer Sites:	ART, PA,CVP, RAP, LAP, ICP		
CO2			
Mode of Sampling:	Sidestream or Mainstream		
Measurement Technology:	Infrared Absorption		
ETCO2 Alarm Limit:	Upper Limit : 20 ~ 100 mmHg Lower Limit : 10 ~ 95 mmHg		
awRR Alarm Limit:	Upper Limit : 10 ~ 150 rpm Lower Limit : 5 ~ 100 rpm		
Apnea Time:	10 ~ 60 s		
Sidestream CO2 Module			
Standards:	ISO 21647		
Principle of Operation:	Non-dispersive Infrared (NDIR) single beam optics, dual wavelength, no moving parts.		
Initialization Time:	Capnogram displayed in less than 20 s, at an ambient temperature of 25°C, full specifications within 2 minutes.		
CO ₂ Measurement Range:	0 ~ 150 mmHg (0 ~ 19.7 %, 0 ~ 20 kPa)		
CO ₂ Calculation Method:	BTPS (Body Temperature Pressure Saturated)		
CO ₂ Resolution:	0 ~ 69 mmHg: 0.1 mmHg		
	70 ~ 150 mmHg: 0.25 mmHg		
CO ₂ Accuracy:	0 ~ 40 mmHg: ± 2 mmHg		
	41 ~ 70 mmHg : ± 5 % of reading		
	71 ~ 100 mmHg: ± 8 % of reading		
	101 ~ 150 mmHg: ±10 % of reading		
	Above 80 breath per minute ± 12 % of reading [NOTE]: Gas temperature at 25°C.		
CO ₂ Stability:	Short Term Drift: Drift over four hours shall not exceed a maximum 0.8 mmHg. Long Term Drift: Accuracy specifications will be maintained over a 120-hour period.		
CO ₂ Noise:	RMS noise of the sensor shall be less than or equal to 0.25 mmHg at 5 % CO ₂		

Sampling Rate:	100 Hz
ETCO ₂ Calculation:	Method: Peak of the expired CO ₂ waveform Selections: 1 breath, 10 s, 20 s
Inspired CO ₂ Measurement:	Range: 3~50 mmHg Method: Lowest reading of the CO ₂ waveform in the previous 20 s Selection: 20 s (not user-selectable)
awRR Measurement Range:	2~150 rpm
awRR Accuracy:	±1 breath
Response Time:	<3 s (includes transport time and rise time)
Mainstream CO₂ Module	
Standards:	ISO 21647
Principle of Operation:	Non-dispersive Infrared (NDIR) single beam optics, dual wavelength, no moving parts.
Initialization Time:	Capnogram displayed in less than 20 s, at an ambient temperature off 25°C, full specifications within 2 minutes.
CO ₂ Measurement Range:	0~150 mmHg (0~19.7 %, 0~20 kPa) (Barometric pressure supplied by host)
CO ₂ Calculation Method:	BTPS (Body Temperature Pressure Saturated)
CO ₂ Resolution:	0~69 mmHg: 0.1 mmHg 70~150 mmHg: 0.25 mmHg
CO ₂ Accuracy:	0~40 mmHg: ± 2 mmHg 41~70 mmHg : ± 5 % of reading 71~100 mmHg: ± 8 % of reading 101~150 mmHg: ±10 % of reading Above 80 breath per minute ± 12 % of reading [NOTE]: Gas temperature at 35°C.
CO ₂ Stability:	Short Term Drift: Drift over four hours shall not exceed a maximum of 0.8 mmHg. Long Term Drift: Accuracy specifications will be maintained over a 120-hour period.
CO ₂ Noise:	RMS noise of the sensor shall be less than or equal to 0.25 mmHg at 7.5 % CO ₂
Sampling Rate:	100 Hz
ETCO ₂ Calculation:	Method: Peak of the expired CO ₂ waveform Selections: 1 breath, 10 s, 20 s [NOTE]: the minimum reported differential value between the baseline and CO₂ value shall be 5 mmHg
Inspired CO ₂ Measurement:	Range: 3~50 mmHg Method: Lowest reading of the CO ₂ waveform in the previous 20 s Selection: 20 s (not user-selectable)
awRR Measurement Range:	0~150 rpm
awRR Accuracy:	±1 rpm
Response Time:	Less than 60 ms – Adult reusable or single patient use Less than 60 ms – Infant reusable or single patient use
ANESTHETIC AGENTS(OPTION, PHASEIN)	
InfraRed Mainstream Analyzer (IRMA)	
Standards:	ISO 21647
Operating Temperature:	IRMA CO ₂ : 0~40°C / 32~104°F
	IRMA OR/OR+ : 10~35°C / 50~95°F
	IRMA AX+ : 10~40°C / 50~104°F
Operating Humidity:	10~95 % RH, non-condensing

Storage and Transportation Humidity:	5~100 % RH, condensing			
Operating Atmospheric Pressure:	IRMA CO ₂ /AX+: 525~1200 hPa (525 hPa corresponding to an altitude of 4 572 m / 15 000 feet)			
	IRMA OR/OR+: 700~1200 hPa (700 hPa corresponding to an altitude of 3 048 m / 10 000 feet)			
Breath Detection:	Adaptive threshold, minimum 1 vol% change in CO ₂ concentration			
Respiration Rate:	0~150 rpm. The respiration rate is displayed after three breaths and the average value is updated every breath.			
Calibration:	Zeroing recommended when changing Airway adapter. No span calibration required for the IR bench. Room air calibration of oxygen sensor performed automatically when charging airway adapter (<5 s)			
Warm-up Time:	Concentration will be reported and the automatic agent identification will be running within 10 s.			
Primary Agent Threshold:	0.15 vol%. When an agent is identified, concentrations will be reported even below 0.15 vol% as long as apnea is not detected.			
Secondary Agent Threshold:	0.2 vol% + 10% of total agent concentration			
Agent Identification Time:	< 20 s (Typically <10 s)			
Total System Response Time:	< 1 s			
[NOTE]: Primary agent threshold is 0.3 vol% for IRMA OR. When the concentration has passed the threshold, the concentration will be reported even below 0.3 vol%.				
Accuracy Specifications—During Standard Conditions				
	Range¹⁾			
Gas	CO ₂	OR	AX+/OR+	Accuracy
CO ₂	0~15	0~10	0~10	±(0.2 vol% + 2 % of reading)
	15~25	10~20	10~15 15~25	±(0.3 vol% + 2 % of reading) Unspecified
N ₂ O	---	0~100	0~100	±(0.2 vol% + 2 % of reading)
HAL, ISO, ENF	---	0~5	0~8	±(0.15 vol% + 5 % of reading) Unspecified
		5~12	8~25	
SEV	---	0~8	0~10	±(0.15 vol% + 5 % of reading) Unspecified
		8~15	10~25	
DES	---	0~18	0~22	±(0.15 vol% + 5 % of reading) Unspecified
		18~25	22~25	
O ₂	---	0~100 ²⁾	0~100 ²⁾	±(1 vol% + 2 % of reading)
[NOTE 1]: Gas concentration reported in units of volume percent.				
[NOTE 2]: IRMA OR/OR+ only.				
Accuracy Specifications-During All Conditions ¹⁾				
Gas	Accuracy			
CO ₂	±(0.3 vol% + 4% of reading)			
N ₂ O	±(2 vol% + 5% of reading)			
Agents ²⁾	±(0.2 vol% + 10% of reading)			
O ₂	±(2 vol% + 2% of reading)			
[NOTE 1]: The accuracy specification is valid for the operating temperature and humidity conditions specified.				
[NOTE 2]: The accuracy specification is not valid if more than two agents are present in the gas mixture.				

ANESTHETIC AGENTS(OPTION, PHASEIN) Infrared Sidestream Analyzer (ISA)	
Standards:	ISO 21647
Mechanical Robustness:	ISA CO ₂ : Meets the shock and vibration requirements for transport of SS-EN ISO 21647:2004 clause 21.102 and SS-EN 1789:2007 clause 6.3.4.2. ISA OR+/AX+: Meets the shock and vibration requirements of SS-EN ISO 21647:2004 clause 21.101
Operating Temperature:	ISA CO ₂ : 0~50 °C (32~122 °F) ISA OR+/AX+: 5~50 °C (41~122 °F)
Storage Temperature:	-40~70 °C (-40~158 °F)
Operation Humidity:	< 4 kPa H ₂ O (non-condensing) (95 %RH at 30 °C)
Storage Humidity:	5~100 %RH (condensing) (100 %RH at 40 °C)
Operating Atmospheric Pressure:	52.5~120 KPa (corresponding to a max altitude of 4 572 m / 15 000 feet)
Storage Atmospheric Pressure:	20~120 kPa (corresponding to a max altitude of 11 760 m / 38 600 feet)
Water Handling:	Sampling line with proprietary water removal tubing
Sampling Lines:	2 ± 0.1 m and 3 ± 0.1 m versions
Breath Detection:	Adaptive threshold, minimum 1 vol% change in CO ₂ concentration.
Respiration Rate:	0~150 ± 1 breaths/minute
Sampling Flow Rate:	50 ± 10 ml/min
Compensations:	ISA CO ₂ : Automatic compensation for pressure and temperature. Manual compensation for broadening effects on CO ₂ . ISA OR+/AX+: Automatic compensation for pressure, temperature and broadening effects on CO ₂ .
Calibration:	No span calibration is required for the IR bench. An automatic zero reference calibration is performed at startup and then every 24 hours ¹ .
Warm-up Time:	ISA CO ₂ : < 10 s (Concentrations reported and full accuracy) ISA OR+/AX+: < 20 s (Concentrations reported, automatic agent identification enabled and full accuracy)
Typical Rise Time at 50 ml/min sample flow:	CO ₂ : ≤200 ms (≤250 ms for ISA OR+/AX+) N ₂ O: ≤350 ms Agents: ≤350 ms O ₂ : ≤450 ms
Primary Agent Threshold: (ISA OR+/AX+)	0.15 vol%. When an agent is identified, concentrations will be reported even below 0.15 vol%
Secondary Agent Threshold: (ISA OR+/AX+)	0.2 vol%+10 % of total agent concentration
Agent Identification Time: (ISA OR+/AX+)	< 20 s (typically < 10 s)
Total System Response Time:	< 3 s (with 2 m sampling line)

Accuracy--Standard Conditions		
The following accuracy specifications are valid for dry single gases at 22 ± 5 °C and 1013 ± 40 hPa.		
Gas	Range ²⁾	Accuracy
CO ₂	0~15 vol% 15~25 vol%	$\pm(0.2 \text{ vol}\% + 2 \% \text{ of reading})$ Unspecified
N ₂ O	0~100 vol%	$\pm(2 \text{ vol}\% + 2 \% \text{ of reading})$
HAL, ENF, ISO	0~8 vol% 8~25 vol%	$\pm(0.15 \text{ vol}\% + 5 \% \text{ of reading})$ Unspecified
SEV	0~10 vol% 10~25 vol%	$\pm(0.15 \text{ vol}\% + 5 \% \text{ of reading})$ Unspecified
DES	0~22 vol% 22~25 vol%	$\pm(0.15 \text{ vol}\% + 5 \% \text{ of reading})$ Unspecified
O ₂	0~100 vol%	$\pm(1 \text{ vol}\% + 2 \% \text{ of reading})$
[NOTE 1]: Every 8 hours for ISA OR+/AX+.		
[NOTE 2]: All gas concentrations are reported in units of volume percent and may be translated into mmHg or kPa by using the reported atmospheric pressure.		
Accuracy--All Conditions		
The following accuracy specifications are valid for all specified environmental conditions.		
Gas	Accuracy	
CO ₂	$\pm(0.3 \text{ kPa} + 4\% \text{ of reading})$	
N ₂ O	$\pm(2 \text{ kPa} + 5\% \text{ of reading})$	
Agents ¹⁾	$\pm(0.2 \text{ kPa} + 10\% \text{ of reading})$	
O ₂	$\pm(2 \text{ kPa} + 2\% \text{ of reading})$	
[NOTE 1]: The accuracy specification is not valid if more than two agents are present in the gas mixture. If more than two agents are present, an alarm will be set.		
Anesthetic Agents(OPTION, DRÄGER)		
Standards:	ISO 21647	
Method:	Infrared Absorption	
Gas Sorts:	Halothane, Isoflurane, Enflurane, Sevoflurane, Desflurane, CO ₂ , N ₂ O, O ₂ (option)	
Zeroing Interval:	Once per day (first zeroing 35 minutes after power on, then once every 24 hours)	
Zeroing Duration:	< 15 s	
Operation Temperature (temperature around module)	$+10^{\circ}\text{C} \sim +50^{\circ}\text{C}$	
Start Up Time (from power on to transmission of measurements with non-ISO accuracy)	< 4 minutes	
Accuracy:	CO ₂ : $\pm (0.43 \text{ vol}\% + 8 \% \text{ rel.})$ N ₂ O: $\pm (2 \text{ vol}\% + 8 \% \text{ rel.})$ Agents: $\pm (0.15 \text{ vol}\% + 15 \% \text{ rel.})$ O ₂ : $\pm (2.5 \text{ vol}\% + 2.5 \% \text{ rel.})$	
Sample Gas Flow Rate:	200 mL/min	
Rise Time:	CO ₂ <= 350 ms N ₂ O <= 350 ms Agents <= 350 ms O ₂ <= 500 ms	
Respiration Rate:	0~80 bpm	
Voltage Input Range:	10.5~62 V	

Measurement Range:	Halothane, Isoflurane: 0~8.5% Enflurane, Sevoflurane: 0~10% Desflurane: 0~20% CO ₂ : 0~10% N ₂ O: 0~100% O ₂ : 0~100%	
NETWORKING		
Wired Networking:	Industry Standard: IEEE 802.3 wired network Possible Connections to Bedside Monitors: Up to 64 bedside monitors RJ45 Interface or RS232 Serial Port	
Wireless Networking:	Industry Standard: 802.11b/g wireless network Transmission Distance : ≥50m (Visual Distance) Frequency Range: 2.400~2.4835 GHz Supports TCP/IP and Wi-Fi Protocols	
POWER		
Source:	External AC Power and Internal Battery	
AC Power:	100~240VAC, 50/60Hz, 150VA	
Battery:	Rechargeable Lithium ion battery	
	Operating time under normal conditions (one battery)	2 hours
	Operating time after first sounding of low-battery alarm	15 minutes
	Number of Batteries	1
Charge Time:	When the monitor is powered off: 3 hours from depletion to 90 percent charge, 4 hours to full charge. When the monitor is powered on: 6 hours from depletion to 90 percent charge, 8 hours to full charge	
ENVIRONMENTAL SPECIFICATIONS		
Temperature:	Operating : 0~40 °C Storage: -20~60 °C	
Humidity Range (Noncondensing):	Operating : 15~95 % Storage : 10~95 %	
PRINTER (OPTION)		
Printer Width:	48 (mm)	
Paper Speed:	25 (mm/s)	
Trace:	1, 2 or 3	
VGA OUTPUT		
Video Signals:	RGB: 0.7Vp-p/75 Ω ; Horizontal/Vertical Synchronization: TTL Level	

EMC

The product is in radio-interference protection class A in accordance with EN55011. The product complies with the requirements of standard EN60601-1-2:2007 "Electromagnetic Compatibility - Medical Electrical Equipment".

NOTE:

- 1) Using accessories, transducers and cables other than those specified may result in increased electromagnetic emission or decreased electromagnetic immunity of the patient monitoring equipment.
- 2) The device or its components should not be used adjacent to or stacked with other equipment. If adjacent or stacked use is necessary, the device or its components should be observed to verify normal operation in the configuration in which it will be used.
- 3) The device needs special precautions regarding EMC and needs to be installed and put into service according to the EMC information provided below.
- 4) Other devices may affect this monitor even though they meet the requirement of CISPR.
- 5) When the inputted signal is below the minimum amplitude provided in technical specifications, erroneous measurements could result.

Guidance and Declaration- Electromagnetic Emissions		
The device is suitable for use in the electromagnetic environment specified below. The customer or the user of the device should assure that it is used in such an environment.		
Emission Tests	Compliance	Electromagnetic Environment-guidance
Radio frequency (RF) emissions CISPR11	Group 1	The device uses RF energy only for its internal function. Therefore, its RF emissions are very low and are not likely to cause any interference in nearby electronic equipment.
RF Emissions CISPR 11	Class A	The device is suitable for use in all establishments other than domestic and those indirectly connected to the public low-voltage power supply network that supplies buildings used for domestic purposes.
Harmonic Emissions IEC 61000-3-2	Class A	
Voltage Fluctuations/Flicker Emissions IEC 61000-3-3	Complies	

ELECTROMAGNETIC IMMUNITY

This section constitutes the guidance and OMNI II Patient Monitor's declaration regarding electromagnetic immunity. The OMNI II Patient Monitor is intended for use in the electromagnetic environment specified below. The customer or the user of the OMNI II Patient Monitor should ensure that it is used in such an environment.

Immunity test	IEC 60601 test level	Compliance level	Electromagnetic environment – guidance
Electrostatic discharge (ESD) IEC 61000-4-2	<input type="checkbox"/> 6 kV contact <input type="checkbox"/> 8 kV air	<input type="checkbox"/> 6 kV contact <input type="checkbox"/> 8 kV air	Floors should be wood, concrete or ceramic tile. If floors are covered with synthetic material, the relative humidity should be at least 30%.
Electrical fast transient/burst IEC 61000-4-4	2 kV for power supply lines 1 kV for input / output lines	<input type="checkbox"/> 2 kV for power supply lines 1 kV for input / output lines	Mains power quality should be that of a typical commercial or hospital environment.

Immunity test	IEC 60601 test level	Compliance level	Electromagnetic environment – guidance
Surge IEC 61000-4-5	<input type="checkbox"/> 1 kV differential Mode <input type="checkbox"/> 2 kV differential Mode	<input type="checkbox"/> 1 kV differential Mode <input type="checkbox"/> 2 kV differential Mode	Mains power quality should be that of a typical commercial or hospital environment.
Voltage dips, short interruptions and voltage variations on power supply input lines IEC 61000-4-11	<5 % UT ¹ (>95 % dip in UT) for 0.5 cycle 40 % UT (60 % dip in UT) for 5 cycles 70 % UT (30 % dip in UT) for 25 cycles <5 % UT (>95 % dip in UT) for 5 sec	<5 % UT ² (>95 % dip in UT) for 0.5 cycle 40 % UT (60 % dip in UT) for 5 cycles 70 % UT (30 % dip in UT) for 25 cycles <5 % UT (>95 % dip in UT) for 5 sec	Mains power quality should be that of a typical commercial or hospital environment. If the user of the OMNI II Patient Monitor requires continued operation during power mains interruptions, then the OMNI II Patient Monitor should be powered from uninterruptible power supply or a battery.
Power frequency (50/60 Hz) magnetic field IEC 61000-4-8	3 A/m	3 A/m	Power frequency magnetic fields should be at level typical location in a commercial or hospital environment.

Note: U_T is the a. c. mains voltage prior to application of the test level.

Immunity test	IEC 60601 test level	Compliance level	Electromagnetic environment – guidance
<p>Conducted RF IEC 61000-4-6</p> <p>Radiated RF IEC 61000-4-3</p> <p>Only ISA CO2 is tested at 20 V/m</p>	<p>3 Vrms 150 kHz to 80 MHz</p> <p>3 V/m 80%AM@2Hz 80 MHz to 2.5 GHz</p> <p>20 V/m 80%AM@1kHz 80 MHz to 2.5 GHz</p>	<p>3 Vrms</p> <p>3 V/m</p> <p>20 V/m</p>	<p>Portable and mobile RF communications equipment should be used no closer to any part of the OMNI II Patient Monitor, including cables, than the recommended separation distance, which can be calculated using the formula applicable to the frequency of the transmitter.</p> <p>The formulas for calculating the recommended separation distance are as follows:</p> $d = 1.2\sqrt{P}$ $d = 1.2\sqrt{P}$ <p>80 MHz to 800 MHz</p> $d = 2.3\sqrt{P}$ <p>800 MHz to 2.5 GHz</p> <p>Where P is the maximum output power rating of the transmitter in watts (W) according to the transmitter manufacturer and d is the recommended separation distance in meters (m).</p> <p>Field strengths from fixed RF transmitters, as determined by an electromagnetic site survey ^{a)}, should be less than the compliance level in each frequency range ^{a)}.</p> <p>Interference may occur in the vicinity of equipment marked with the following symbol:</p> 
<p>[NOTE 1]: At 80 MHz and 800 MHz, the higher frequency range applies.</p> <p>[NOTE 2]: These guidelines may not apply in all situations. Electromagnetic propagation is affected by absorption and reflection from structures, objects and people.</p> <p>a). Field strengths from fixed transmitters, such as base stations for radio (cellular/cordless) telephones and land mobile radios, amateur radio, AM and FM radio and TV broadcasters cannot be accurately predicted theoretically. To assess the electromagnetic environment due to fixed RF transmitters, an electromagnetic site survey should be conducted. If the measured field strength in the location in which the OMNI II Patient Monitor is used exceeds the applicable RF compliance level, verify that the OMNI II Patient Monitor works normally. If you observe abnormal performance, you may need to reorient or relocating the OMNI II Patient Monitor.</p> <p>b). Over the frequency range of 150 kHz to 80 MHz, field strengths should be less than 3V/m.</p>			

Immunity test	IEC 60601 test level	Compliance level	Electromagnetic environment – guidance	
Recommended separation distance between portable and mobile RF communications equipment and the OMNI II Patient Monitor				
<p>The OMNI II Patient Monitor is intended for use in an electromagnetic environment in which radiated RF disturbances are controlled.</p> <p>The customer or the user of the OMNI II Patient Monitor can help prevent electromagnetic interference by maintaining a minimum distance between portable and mobile RF communications equipment (transmitters) and the OMNI II Patient Monitor as recommended below, according to the maximum output power of the communications equipment</p>				
Rated maximum output power of transmitter [W]	Separation distance according to frequency of transmitter [m]			
	150 kHz to 80 MHz $d = 1.2\sqrt{P}$	80 MHz to 800 MHz $d = 1.2\sqrt{P}$	800 MHz to 2.5 GHz $d = 2.3\sqrt{P}$	
0.01	0.12	0.12	0.23	
0.1	0.38	0.38	0.73	
1	1.2	1.2	2.3	
10	3.8	3.8	7.3	
100	12	12	23	
<p>For transmitters rated at a maximum output power not listed above, the recommended separation distance d in meters (m) can be estimated using the formula applicable to the frequency of the transmitter, where P is the maximum output power rating of the transmitter in watts (W) according to the transmitter manufacturer.</p>				