



CLEO  
Patient Monitor

## USER'S MANUAL

## Infinium Medical Inc.

Website: [www.infiniummedical.com](http://www.infiniummedical.com)

Address: 12151 62nd St North #5

Largo FL, 33773 USA

Toll Free (US call only): 866-918-8434

International: 1-727-531-8434

Fax: 1-727-531-8436

To obtain information about a warranty, if any, for this product, contact Infinium Medical Inc, Technical Services or your local Infinium Medical, Inc. representative.

***RESPIRONICS is a trademark of PHILIPS RESPIRONICS***



***Masimo is a trademark of Masimo SET***



## CONTENTS

SAFETY INFORMATION .....	4
INTRODUCTION .....	8
INTENDED USE .....	8
ABOUT THIS MANUAL .....	8
CONTROLS, INDICATORS, AND SYMBOLS .....	9
FRONT AND SIDE PANEL .....	9
REAR PANEL .....	11
SYMBOLS .....	12
DISPLAY SCREEN PARTITION .....	14
SYSTEM SETUP .....	16
FACTORY SEVICING SETUP .....	16
SOUND VOLUME .....	17
BRIGHTNESS .....	17
ALARM SWITCH .....	17
LANGUAGE CHOOSE .....	17
DISPLAY MODE .....	18
CLOCK SETUP .....	18
SCREEN CALIBRATION .....	18
PRINTER SETUP .....	18
HL7 SETUP .....	18
DEFAULT CONFIG .....	19
SAVE CONFIG .....	19
HOW TO MONITOR .....	20
ALARM & SOUND .....	21
ALARM .....	21
SOUND .....	22
SPO2 MONITORING .....	23
SPO2 MONITORING PRINCIPLE .....	23
SPO2 SENSOR INSTALLATION .....	23
SPO2 WAVEFORM SETUP .....	23
SPO2 PARAMETER SETUP .....	24
MEASUREMENT LIMITATIONS .....	25
SPO2 ERROR MESSAGES .....	26
MASIMO INFORMATION .....	27
NIBP MONITORING .....	32
SUMMARY ON NIBP MONITORING .....	32
NIBP CUFF FITTING .....	32

NIBP MONITORING INITIALIZATION .....	33
NIBP PARAMETER SETUP .....	33
NIBP LIST OBSERVATION.....	36
MEASUREMENT LIMITATIONS .....	37
NIBP ERROR MESSAGES.....	37
MAINTAINENCE AND CLEANING.....	37
QUICK TEMP MONITORING .....	39
ABOUT BODY TEMPERATURES .....	39
GENERAL INFORMATION.....	39
SAFETY AND WARING .....	40
INSTRUCTION FOR USE.....	40
QTEMP PARAMETER SETUP .....	44
QTEMP LIST OBSERVATION .....	45
MAINTAINENCE AND CLEANING.....	46
ETCO2 MONITORING.....	47
THEORY OF OPERATION.....	47
WARNINGS, CAUTIONS AND NOTES .....	47
ABBREVIATIONS AND TERMINOLOGY .....	48
ZEROING THE CO2 MODULE.....	48
PATIENT AND TUBING PREPARATION .....	49
ETCO2 WAVEFORM SETUP .....	50
ETCO2 PARAMETER SETUP .....	51
ADVANCED SETUP.....	52
CALIBRATION .....	53
STATUS/ERROR MESSAGES .....	54
MAINTENANCE AND CLEANING.....	54
RECALL DATA.....	56
PATIENT BASIC INFORMATION SETUP.....	56
CLOCK SETUP.....	56
HOW TO RECALL .....	57
BATTERY OPERATION.....	60
BATTERY RECYCLE.....	60
DISPOSAL OF DEVICE COMPONENTS .....	61
CLEANING.....	62
PERIODIC SAFETY CHECKS .....	62
SPECIFICATIONS .....	63
EMC .....	68
ELECTROMAGNETIC IMMUNITY .....	68

## FIGURES

Figure 1: Front and Side Panel (With Masimo SpO <sub>2</sub> Module) .....	9
Figure 2: Front and Side Panel (With Infinium SpO <sub>2</sub> Module) .....	10
Figure 3: Rear View for Main Unit .....	11
Figure 4: Tree Diagram for System Setup Menu .....	16
Figure 5: Window for Ethernet IP Address Setup .....	17
Figure 6: Tree Diagram for Pleth Menu .....	23
Figure 7: Tree Diagram for SpO <sub>2</sub> Setup Menu .....	24
Figure 8: Tree Diagram for NIBP Setup Menu .....	33
Figure 9: Window for NIBP List Observation.....	36
Figure 10: Sketch Map for Replacing the Bladder .....	38
Figure 11: Temperature Site and Patient Age .....	39
Figure 12: Tree Diagram for QTemp Setup Menu .....	44
Figure 13: Window for QTemp List Observation .....	45
Figure 14: Tree Diagram for EtCO <sub>2</sub> Waveform Setup Menu .....	50
Figure 15: Tree Diagram for EtCO <sub>2</sub> Parameter Setup Menu .....	51
Figure 16: Tree Diagram for EtCO <sub>2</sub> Advanced Setup .....	52
Figure 17: Tree Diagram for Patient Setup .....	56
Figure 18: Tree Diagram for Clock Setup.....	57
Figure 19: Tabular Trend for SpO <sub>2</sub> .....	58
Figure 20: Tabular Trend for EtCO <sub>2</sub> .....	58
Figure 21: Tabular Trend for NIBP .....	59
Figure 22: Tabular Trend for QTemp .....	59

## SAFETY INFORMATION

This section contains important safety information relating to general use of the CLEO Patient Monitor. Other important safety information appears throughout the manual in sections that relate specifically to the precautionary information. Read all text surrounding all precautionary information.

The CLEO can be powered by an internal battery that provides 3 hours of monitoring from fully charged batteries. The batteries are continuously recharged when AC power is connected to the monitor.

A warning message appears on the screen and an audible alarm sounds when the remaining battery power is only enough for 10 minutes of operation. The user should connect the monitor to an external power source to avoid loss of patient monitoring action. External power sources may be connected, disconnected, and reconnected without interrupting the monitoring action.

**[NOTE]:** Before use, please read this manual carefully.

**[WARNING]:** CLEO Patient Monitor is not an apnea monitor.

**[WARNING]:** The CLEO Patient Monitor should not be used as the sole basis for medical decisions. It must be used in conjunction with clinical signs and symptoms.

**[WARNING]:** CLEO Patient Monitor is defibrillator proof. It may be used during defibrillation, but this may affect the accuracy or availability of the parameters and measurements.

**[WARNING]:** The CLEO Patient Monitor may be used during electrocautery, but this may affect the accuracy or availability of the parameters and measurements.

**[WARNING]:** Do not adjust, repair, open, disassemble, or modify the CLEO patient monitor or accessories. Injury to personnel or equipment damage could occur. Return the CLEO for servicing if necessary.

**WARNING:** CLEO patient monitor is a prescription device and is to be operated by qualified personnel only.

**[WARNING]:** Explosion hazard. DO NOT use the CLEO monitor in the presence of flammable anesthetics or other flammable substance in combination with air, oxygen-enriched environments, or nitrous oxide.

**[WARNING]:** DO NOT lift the monitor by the sensor cable, blood pressure hose, or power cord because the cable, lead, or cord could disconnect from the monitor, causing the monitor to drop on the patient.

**[WARNING]:** CLEO Patient Monitor may not operate effectively on patients who are experiencing convulsions or tremors.

**[WARNING]:** Do not use CLEO if it appears or is suspected to be damaged.

**[WARNING]:** Do not use the CLEO and sensors during magnetic resonance imaging (MRI) scanning or in an MRI environment. Use during MRI could cause burns or adversely affect the MRI image or the monitor's accuracy. Also, to avoid burns, remove the sensors from the patient before conducting MRI.

**[WARNING]:** To ensure that the leakage current protection remains within the specifications, use only the patient cables supplied with or specifically intended for use with the CLEO Monitors.

**[WARNING]:** The user must check the equipment prior to use and ensure its safe and proper use. Do not start or operate the CLEO unless the setup was verified to be correct.

**[WARNING]:** As with all medical equipment, carefully route patient cabling to reduce the possibility of patient entanglement or strangulation.

**[WARNING]:** To ensure patient safety, DO NOT place the monitor or accessories in any position that might cause it to fall on the patient.

**[WARNING]:** To ensure safety, avoid stacking multiple devices or placing anything on the device during operation.

**[WARNING]:** To protect against injury, follow the directions below:

- Avoid placing the device on surfaces with visible liquid spills.
- Do not soak or immerse the device in liquids.
- Do not attempt to sterilize the device.
- Use cleaning solutions only as instructed in this operator's manual.
- Do not attempt to clean the device while monitoring a patient.

**[WARNING]:** To protect from electric shock, always remove the sensor and completely disconnect the CLEO before bathing the patient.

**[WARNING]:** Enclosure leakage current is less than 100 microamperes ( $\mu\text{A}$ ); however, always consider additional leakage current that can be caused by other equipment used on the patient at the same time as these monitors.

**[WARNING]:** DO NOT autoclave, ethylene oxide sterilize, or immerse these monitors in liquid. Use the cleaning solution sparingly. Excessive solution can flow into the monitor and cause damage to internal components. Do not use petroleum-based or acetone solutions, or other harsh solvents, to clean the monitor. These substances attack the monitor's materials and device failure can result. Unplug the monitors before cleaning or disinfecting.

**[WARNING]:** DO NOT touch, press, or rub the display panels with abrasive cleaning compounds, instruments, brushes, rough surface materials, or bring them into contact with anything that could scratch the panel.

**[WARNING]:** DO NOT use the CLEO to monitor patients who are linked to heart/lung machines.

**[WARNING]:** To prevent electrical hazards to all personnel, CLEO Patient Monitor must be properly grounded. The chassis grounding assembly, Universal Switching Power Supply, and the power cord supplied with the equipment provide for this protection. DO NOT undo this protection by modifying the cords or using ungrounded adapters. DO NOT remove the monitor cover except to replace the battery.

**[WARNING]:** Connect the monitor only to a three-wire, grounded, hospital-grade receptacle. The three-conductor plug must be inserted into a properly wired three-wire receptacle; if a three-wire receptacle is not available, a qualified electrician must install one in accordance with the governing electrical code.

**[WARNING]:** If there is any doubt about the integrity of the protective earth conductor arrangement, operate the monitor on internal battery power until the AC power supply protective conductor is fully functional.

**CAUTION:** When connecting the CLEO to any instrument, verify proper operation before clinical use. Both the CLEO and the instrument connected to it must be connected to a grounded outlet. Accessory equipments connected to this patient monitor must be certified according to the respective IEC standards (e.g. IEC 60950 for information technology equipment and IEC 60601-1 for medical electrical equipment). Furthermore, all configurations shall comply with the valid version of the system standard IEC 60601-1-1.

Any person who connects additional equipment to the signal input or signal output is responsible to ensure the system complies with the requirements of the valid version of the system standard IEC 60601-1-1. If you have any questions, please be free to contact our company or customer service.

To ensure accurate readings, consider current environmental conditions and the condition of the patient. See the appropriate sections of the manual for specific safety information related to these conditions.

Do not place the CLEO monitor where the controls can be changed by the patient.

Electrical shock and flammability hazard: Before cleaning, always turn off the device and disconnect from any power source.

When patients are undergoing photodynamic therapy, they may be sensitive to light sources. CLEO monitor may be used only under careful clinical supervision for short time periods to minimize interference with photodynamic therapy.

Do not place the CLEO monitor on electrical equipment that may affect the device, preventing it from working properly.

Do not submerge the CLEO monitor in any cleaning solution or attempt to sterilize by autoclave, irradiation, steam, gas, ethylene oxide or any other method. This will seriously damage the pulse oximeter.

Electrical Shock Hazard: Carry out periodic tests to verify that leakage currents of patient-applied circuits and the system are within acceptable limits as specified by the applicable safety standards. The summation of leakage currents must be checked and in compliance with IEC 60601-1 and UL60601-1. The system leakage current must be checked when connecting external equipment to the system. When an event such as a component drop of approximately 1 meter or greater or a spillage of blood or other liquids occurs, retest before further use. Injury to personnel could occur.

Disposal of product - Comply with local laws in the disposal of the device and/or its accessories.

To minimize radio interference, other electrical equipment that emits radio frequency transmissions should not be in close proximity to the CLEO monitor.

## INTRODUCTION

- INTENDED USE
- ABOUT THIS MANUAL

### INTENDED USE

CLEO Patient Monitor is a comprehensive monitoring system compiling, processing, analyzing and displaying data from up to four different patient parameters. It integrates parameter measuring modules and display in one device, and is compact, lightweight and portable. Built-in battery facilitates portability.

The purpose and function of CLEO Patient Monitor is to monitor NIBP (Systolic, Diastolic and Mean Arterial Pressures), SpO<sub>2</sub>, EtCO<sub>2</sub> and QTemp (Quick Temperature) for adult patients in all hospital areas and hospital-type facilities. It may be used during hospital transport and in mobile.

The CLEO monitor offers advanced features such as an intuitive touch screen with clinical measurements, one-touch commands, crisp and clear display.

**[WARNING]:** CLEO Patient Monitor is intended only as an adjunct in patient assessment. It must be used in conjunction with clinical signs and symptoms.

### ABOUT THIS MANUAL

This manual explains how to set up and use the CLEO Patient Monitor. Important safety information relating to general use of the CLEO appears before this introduction. Other important safety information is located throughout the text where applicable. **Read the entire manual including the Safety Information section before you operate the monitor.**

## CONTROLS, INDICATORS, AND SYMBOLS

- FRONT AND SIDE PANEL
- REAR PANEL
- SYMBOLS

### FRONT AND SIDE PANEL

#### CLEO with Masimo SpO<sub>2</sub> Module

(Attention: Masimo SpO<sub>2</sub> Module is the default setting.)

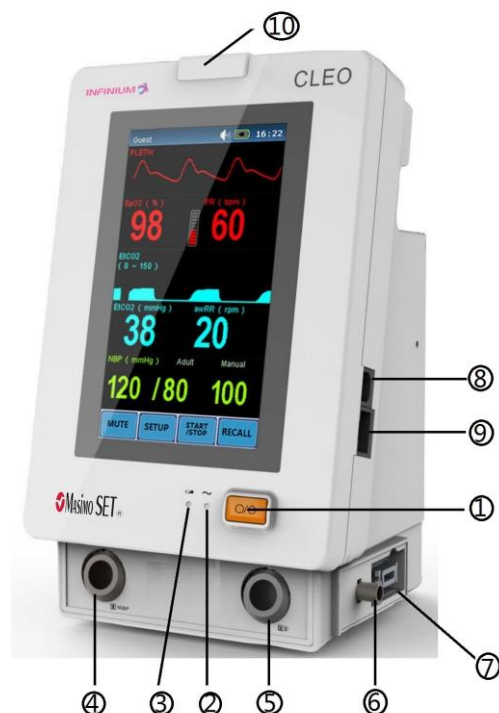
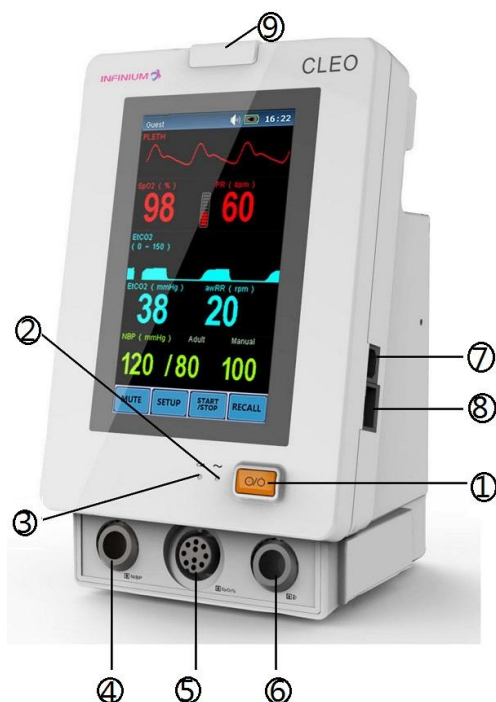

Figure 1: Front and Side Panel (With Masimo SpO<sub>2</sub> Module)

No.	Function	Icon
1.	POWER SWITCH This toggle switch turns the secondary power from on to off. The monitor will continue to charge the battery as long as the AC cable is plugged in, even if the power switch is turned off.	
2.	AC ON This LED indicates that the monitor is powered by AC.	
3.	DC ON This LED indicates that the monitor is powered by battery.	
4.	NIBP Port for the connection with the blood pressure cuff hose	
5.	Sensor Port for External EtCO <sub>2</sub> /QTemp	
6.	Air Pipe for Inner EtCO <sub>2</sub>	
7.	<b>Oxygen Saturation Sensor Port for Masimo SET SpO<sub>2</sub></b>	
8.	USB Port Transfer data to PC; Upgrade program	
9.	Ethernet Port Upgrade program	
10.	Alarm Indicator	

**CLEO with Infinium SpO<sub>2</sub> Module**



**Figure 2: Front and Side Panel (With Infinium SpO<sub>2</sub> Module)**



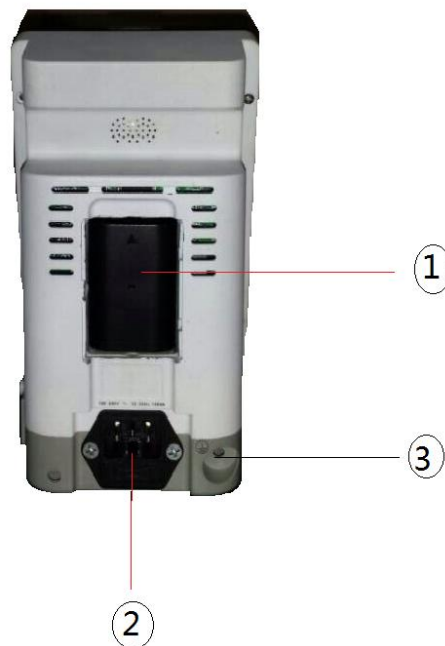







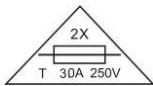

No.	Function	Icon
1.	POWER SWITCH This toggle switch turns the secondary power from on to off. The monitor will continue to charge the battery as long as the AC cable is plugged in, even if the power switch is turned off.	
2.	AC ON This LED indicates that the monitor is powered by AC.	
3.	DC ON This LED indicates that the monitor is powered by battery.	
4.	NIBP Port for the connection with the blood pressure cuff hose	
5.	Oxygen Saturation Sensor Port for Infinium SpO <sub>2</sub>	
6.	Sensor Port for External EtCO <sub>2</sub> /QTemp	
7.	USB Port Transfer data to PC; Upgrade program	
8.	Ethernet Port Upgrade program	
9.	Alarm Indicator In normal mode, no indicator lights. In alarm mode, the alarm indicator lights up or flashes.	



**REAR PANEL****Figure 3: Rear View for Main Unit**

No.	Function	Icon
1	Battery Access	
2	AC Input and Fuse The AC power connection is where the power cord is connected to the monitor. The AC power fuse must be replaced with the same type of fuse.	100/240V~50/60Hz, 30VA, F2AL 250V
3	Equipotential Grounding Solve the ground loop and mains problem by designing several alternate courses for electrical energy to finds its way back to ground.	

## SYMBOLS

The following symbols may appear on the packaging, monitor or in user's manual:

	Type BF Applied Part
<b>SN</b>	Manufacture's Serial Number
	Fuse Information
	Date of Manufacture
	Manufacturer
	Fragile Contents of the transport package are fragile; therefore, it should be handled with care.
	This Way Up Indicates correct up right position of the transport package.
	Keep Away From Rain Transport package should be kept away from rain.
	Stacking Limit By Number Maximum number of identical packages that may be stacked on one another is eight.
	General Warning, Caution, Risk Of Danger Please read the instructions carefully before operating the product.
	Stand-by To identify the switch or switch position by means of which part of the equipment is switched on in order to bring it into the stand-by condition.
	To signify that the instruction manual/booklet must be read
	Separate collection for waste of electrical and electronic equipment. Do not dispose of battery in municipal waste. The symbol indicates separate collection for battery is required.
	Indicates the temperature limits to which the medical device can be safely exposed

	Indicates the range of humidity to which the medical device can be safely exposed
<b>IPX1</b>	IPX1: N1=X, which means it was not required; N2=1, Protection against vertically falling water drop
<b>Rx Only</b>	Caution: Federal law (USA) restricts this device to sale by or on the order of a licensed healthcare practitioner.
	A marking by which a manufacturer indicates that a device is in conformity with the applicable requirements set out in this Regulation and other applicable Union harmonization legislation providing for its affixing

## DISPLAY SCREEN PARTITION

There are eight groups for module combination in all. The user can choose what to measure as required in Display Mode.

The module combinations are as below:

- ◆ EtCO<sub>2</sub>
- ◆ NIBP
- ◆ SpO<sub>2</sub> + NIBP
- ◆ SpO<sub>2</sub> + EtCO<sub>2</sub>
- ◆ EtCO<sub>2</sub>+ NIBP
- ◆ SpO<sub>2</sub> + EtCO<sub>2</sub> + NIBP
- ◆ SpO<sub>2</sub> + NIBP + QTemp
- ◆ EtCO<sub>2</sub>+NIBP+QTemp (available only when EtCO<sub>2</sub> module type is internal)

The display interface is as below:

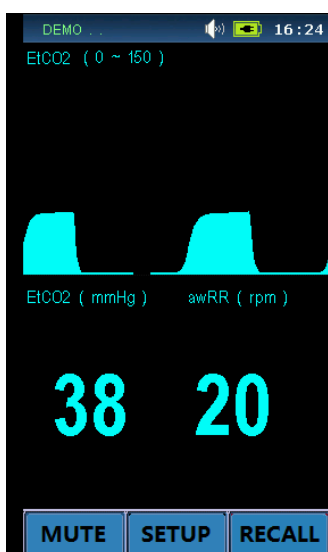

Single EtCO<sub>2</sub>

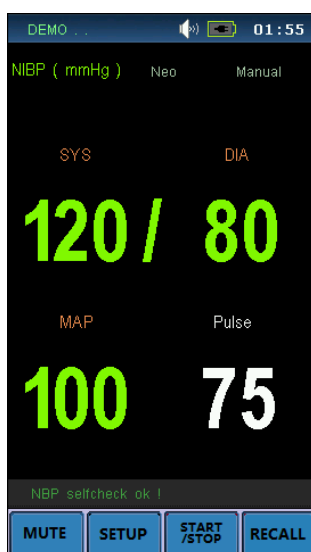

Single NIBP

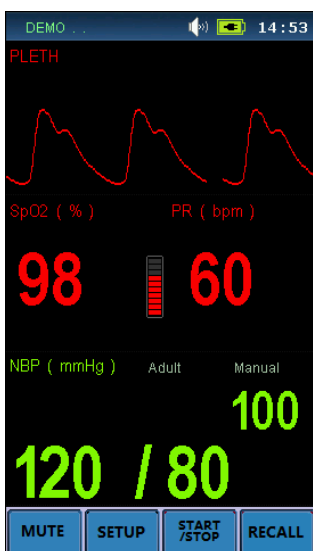

SpO<sub>2</sub> + NIBP

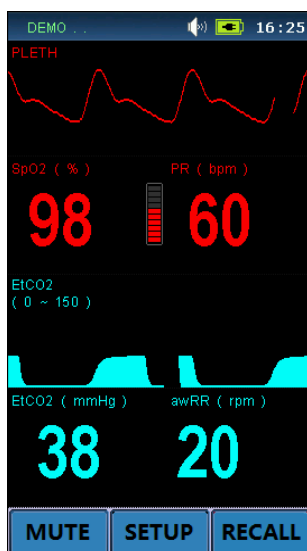

SpO<sub>2</sub> + EtCO<sub>2</sub>

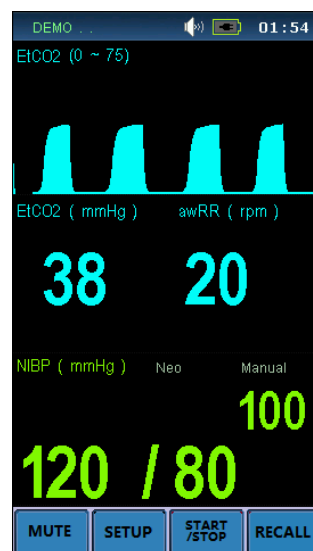

EtCO<sub>2</sub>+ NIBP



SpO<sub>2</sub> + EtCO<sub>2</sub> + NIBP

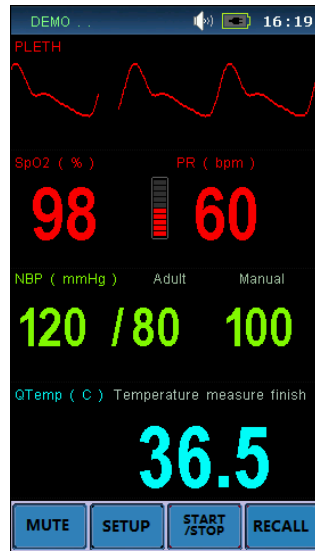

SpO<sub>2</sub> + NIBP + QTemp

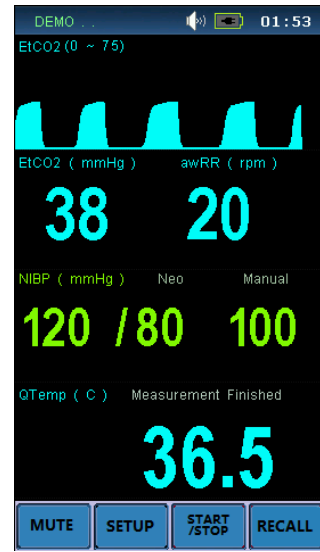

EtCO<sub>2</sub> + NIBP + QTemp

## SYSTEM SETUP

System Setup includes: Factory Setup, Demo Switch, Sound Volume, Brightness, Alarm Switch, Language Choose, Display Mode, Clock Setup, Default Config, Save Config and etc.

Press the **SETUP** button to open the System Setup menu, the tree diagram is as below:

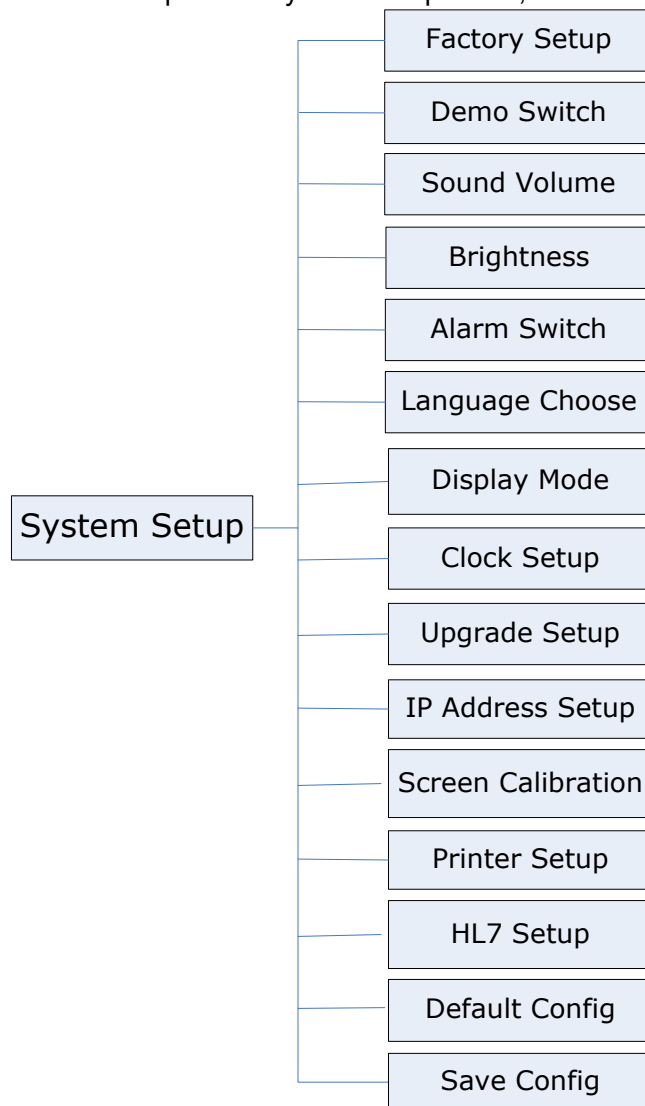

**Figure 4: Tree Diagram for System Setup Menu**

## FACTORY SEVICING SETUP

For servicing engineers use only.

1. If you input "IPSETUP." for the password, the "IP Address Setup" menu item would be activated. Press the IP Setup menu, Patient Monitor will open the window as follows:



**Figure 5: Window for Ethernet IP Address Setup**

If click OK item, the Ethernet IP address setup of the Patient Monitor is set and saved. This IP address is available only when the patient monitor is re-powered on.

2. If you input "DEMO..." for the password and then open the Demo Switch, you will see the simulation measurement.  
The Demo mode is for demonstration purpose only. To avoid that the simulated data are mistaken for the monitored patient's data, you must not change into demo mode during monitoring, otherwise, improper patient monitoring and delayed treatment could result.
3. If you input "SCREEN.." for the password, the "Screen Calibration" menu item will be activated. Enter the menu; you could calibration the monitor touch-screen.
4. If you input "UPGRADE.." for the password, the Upgrade Setup Menu will be enabled. This function is for servicing engineer only.

## SOUND VOLUME

Mainly use to adjust the sound to four levels, separately they are: I , II , III and IV. IV is the loudest and I is the lowest. Also it can be set to OFF.

## BRIGHTNESS

Select the appropriate setting for the screen brightness. IV is the brightest, and I is the least bright.

If the patient monitor operates on battery power, you can set a less bright screen to prolong the operating time of the battery.

## ALARM SWITCH

It could be chosen ON or OFF. When it is ON, the alarm is enabled, and then you should set the each parameter's alarm switch in the Parameter Setup. When it is OFF, the alarm is disabled which means all alarm is closed.

## LANGUAGE CHOOSE

Use to select language for the monitor system. The language can be switched only after

inputting the correct password of "language". It could be chosen English or Spanish.

## DISPLAY MODE

There are nine groups for module combination in all. Choose which module combination is to display as you want.

### **[NOTE]**

1. The module combination 'EtCO<sub>2</sub> + NIBP + QTemp' is available only when the EtCO<sub>2</sub> module type is internal.
2. The display mode will switch to 'EtCO<sub>2</sub>+NIBP' if the EtCO<sub>2</sub> module type changes to external under the 'EtCO<sub>2</sub> + NIBP + QTemp' display mode.

## CLOCK SETUP

Refer to the Chapter RECALL DATA for detailed information.

## SCREEN CALIBRATION

Calibrate the touch screen; the detailed operation is to see Factory Setup.

## PRINTER SETUP

### TIME INTERVAL

Set the time interval of automatic printing. Available interval ranges from 1 minute to 60 minutes.

### AUTO PRINT SWITCH

If the "Auto Print Switch" is ON, then after related time interval, the monitor will automatically print the current measured module's history data. If the "Auto Print Switch" is OFF, the Auto Print function is disabled.

### PRINTER IP ADDRESS

Set the IP Address for printer, and make the printer connect with the monitor via the Ethernet.

## HL7 SETUP

### ENABLE SERVICE

No or Yes could be chosen, if you choose 'No', the HL7 service is closed. And if you choose 'Yes', the HL7 service is enabled.

### REPORT INTERVAL

Set the time interval of reporting waveforms and parameters. After you enable the HL7 Service, this item is changeable. You can set 1s, 5s, 10s, 15s, 20s, 25s and 30s.

### REPORT WAVEFORM

After you enable the HL7 Service, this item is changeable. If you choose ON, the monitor will send the measured waveforms and parameters via the Ethernet port. If you choose OFF, the monitor will only send the measured parameters.

### REMOTE ADDRESS

Set the server's IP Address and port. After you enable the HL7 Service, this item is changeable.

## DEFAULT CONFIG

If the parameter settings are invalid, you can call the Default Config to recover the original settings. The screen will display a menu to let you confirm the setup.

After returning to the above confirmation menu, a message of "Load Successfully!" will display in the message highlight area, showing that the system has begun to work with the new settings.

## SAVE CONFIG

You can change monitor settings as required and then save the changed settings. The screen will display a menu to let you confirm the setup:

After returning to the above confirmation menu, a message of "Save successfully!" will display in the message highlight area, showing that the system and all monitoring parameter settings have been saved (see each chapter).

**[NOTE]**

Make sure that the changes are suitable for your patient.

## HOW TO MONITOR

1. Depending on the parameter needed, connect the correlated sensors to the sockets on the bottom of the panel;
2. Connect to the power supply, and press the power switch in the front panel;
3. Power indicator should light up, and the display screen will enter the main screen after 10 seconds;
4. Connect the detector with the patient;
5. Set monitoring parameters (see chapters below) ;
6. Enter the monitoring state.

**[CAUTION]:** If the CLEO is to be stored for a period of 2 months or longer, notify service personnel to remove the battery from the monitor prior to storage. Recharge the battery when the battery has not been recharged for 2 or more months.

**[CAUTION]:** Follow local government ordinances and recycle instructions regarding disposal or recycling of device components, including batteries.

## ALARM & SOUND

### ALARM

When the monitor detects certain conditions that require user attention, the CLEO Patient Monitor enters an alarm state. The monitor response will include:

- Visual alarm indicators
- Audible alarm indicators

### ALARM PRIORITY

The monitor's visual and audible responses to a detected alarm depend on the priority of the alarm; High, Medium, or Low.

**[WARNING]:** Do not silence the audible alarm or decrease its volume if patient safety could be compromised.

A higher priority alarm will supersede a lower priority alarm.  
The three categories of alarms are summarized in the following paragraphs.

#### HIGH PRIORITY

Indicates that immediate response from the operator is required for the following scenario(s):

No breath (4 seconds have passed with no breath from EtCO<sub>2</sub>)

#### MEDIUM PRIORITY

Indicates that prompt response from the operator is required for the following scenario(s):

High/Low numeric value limits violated (such as High/Low SpO<sub>2</sub> limits violated, High/Low Sys./Dia. blood pressure limits violated, High/Low Temperature limits violated, etc.).

#### LOW PRIORITY

Indicates that awareness from the operator is required for the following scenario(s):

Module communicates error (such as SpO<sub>2</sub> com error).

Sensor off (Such as SpO<sub>2</sub> sensor disconnect)

### VISUAL ALARM INDICATORS

When an alarm occurs, the CLEO responds with visual alarm indicators. The flashing rates for the three categories of alarms are shown below. The CLEO uses flashing lights to indicate high and medium priority alarms, as shown below.

Alarm Category	Flashing Rate
High Priority	Two flashes in 1 second
Medium priority	One flash in 2 seconds
Low priority	Constant (on) (non-flashing)

When a low priority alarm occurs, a non-flashing alarm message appears in the parameter area. On the CLEO the alarm led color will change to a solid yellow for a low priority alarm

A medium priority alarm is activated when a parameter is outside its alarm limits. The parameter value in the corresponding parameter area will flash every 1 second. And the alarm led will flash yellow at the medium priority rate.

When the high-priority No breath alarm occurs, the alarm led color will flash red. A non-flashing No breath message appears in the message area and will override any

other messages that may be present.

## SOUND

### ALARM SOUND

There are four alarm levels to choose from, ranging from low to high: I , II , III and IV.

The following encoded auditory alarm signals can be categorized by alarm condition and priority:

Alarm Category	Encoded Auditory
High Priority	c c c-c c
Medium priority	c c c
Low priority	e C
<p><b>[NOTE 1]:</b> The characters c,e refer to relative musical pitches and C is one octave c.  <b>[NOTE 2]:</b> A high priority alarm signal is generated with the five pulses, repeat once, for total of 10 pulses.</p>	



### PULSE-TONE

The pulse-tone is a sound of RUB-A-DUB.

### KEY BEEPS

The key beep sounds come along with clicking function items.

### MUTE

Click MUTE soft-key to enable or disable all sounds. First click MUTE soft-key, the  symbol will display in the message area. Click the MUTE again, the sound recovers to be normal and the  symbol would display in the message area.

## SPO2 MONITORING

- SPO2 MONITORING PRINCIPLE
- SPO2 SENSOR INSTALLATION
- SPO2 WAVEFORM SETUP
- SPO2 PARAMETER SETUP
- MEASUREMENT LIMITATIONS
- SPO2 ERROR MESSAGES
- MASIMO INFORMATION

### SPO2 MONITORING PRINCIPLE

Arterial oxygen saturation is measured by a method called pulse oximetry. It is a continuous, non-invasive method based on the different absorption spectra of reduced hemoglobin and oxyhemoglobin. It measures how much light, sent from light sources on one side of the sensor, is transmitted through patient tissue (such as a finger or an ear), to a receiver on the other side.

The amount of light transmitted depends on many factors, most of which are constant. However, one of these factors, the blood flow in the arteries, varies with time, because it is pulsating. By measuring the light absorption during a pulsation, it is possible to derive the oxygen saturation of the arterial blood. Detecting the pulsation gives a PLETH waveform and pulse rate signal.

#### About SpO<sub>2</sub>, SaO<sub>2</sub>, SjvO<sub>2</sub>

- SpO<sub>2</sub>: It is the arterial blood oxygen saturation level measured by oximeter.
- SaO<sub>2</sub>: It is the oxygen saturation of arterial blood
- SjvO<sub>2</sub>: It is the oxygen saturation of the jugular blood.

#### **[WARNING]**

Pulse oximeter can overestimate the SpO<sub>2</sub> value in the presence of HB-CO, Met-HB or dye dilution chemicals.

### SPO2 SENSOR INSTALLATION

1. Insert the plug of SpO<sub>2</sub> sensor into the SpO<sub>2</sub> socket at the bottom of panel of monitor. Make sure that the salient of plug must direct to the notch of socket when inserting or unplugging, otherwise the measurement will not be reliable and the sensor connector will be damaged.
2. Wear the finger-probe on the finger; make sure that the finger tip is the same direction as the finger direction indicated on the probe.

### SPO2 WAVEFORM SETUP

Touch the SpO<sub>2</sub> Waveform area directly. The tree diagram is as below:

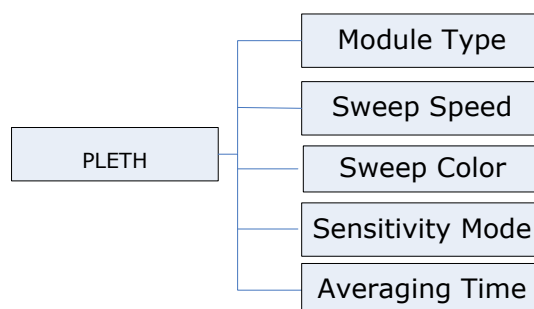

**Figure 6: Tree Diagram for Pleth Menu**

The menu has the following settings:

**MODULE TYPE**

There are two SpO<sub>2</sub> modules to choose from: Masimo and Infinium. For more detail please contact local distributor or service engineer.

**SWEEP SPEED**

Choose from 12.5mm/s or 25.0mm/s, and the factory setting is 25 mm/s.

**SWEEP COLOR**

Choose from Yellow, White, Blue, Red, Green and Cyan. The default setting is Red.

**SENSITIVITY MODE**

This item is adjustable only when the SpO<sub>2</sub> module is Masimo. According to the patient status, you could choose different sensitivity mode. The default setting is Normal.

- Maximum Mode: This mode should be used for the sickest patients, where obtaining a reading is most difficult. Maximum Sensitivity is designed to interpret and display data for even the weakest of signals. This mode is recommended during procedures and when clinician and patient contact is continuous.
- Normal Mode: This mode provides the best combination of sensitivity and probe-off detection performance. This mode is recommended for the majority of patients.
- APOD (Adaptive Probe off Detection) Mode: This mode is the least sensitive in picking up a reading on patients with low perfusion but has the best detection for probe-off conditions. This mode is useful for patients that are at particular risk of the sensor becoming detached (Pediatric, combative, etc.).

**AVERAGING TIME**

Set the averaging interval time to obtain SpO<sub>2</sub> value from Masimo module. This item is adjustable only when the SpO<sub>2</sub> module is Masimo. You could choose 2-4s, 4-6s, 8s, 10s, 12s, 14s and 16s.

**SPO2 PARAMETER SETUP**

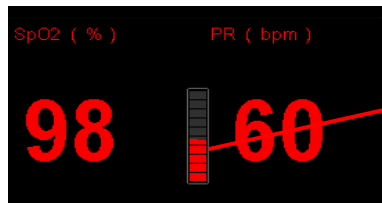

**PULSE BARGRAPH:**  
 Use red bargraph to express the intensity of the pulse of patient.  
 Pulse bargraph is throbbing upon with the pulse.

Touch the SpO<sub>2</sub> Parameter area directly. The tree diagram for SpO<sub>2</sub> Setup Menu is as below:

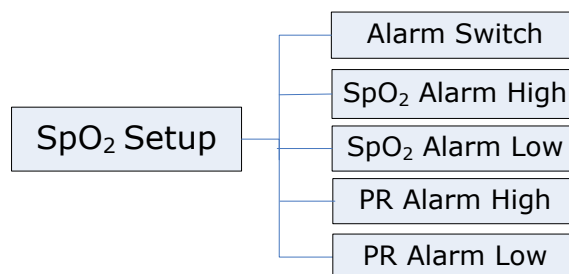

**Figure 7: Tree Diagram for SpO<sub>2</sub> Setup Menu**

## ALARM SWITCH

ON and OFF for choice, the factory setting is ON.

If the SpO<sub>2</sub> value is above or below the SpO<sub>2</sub> alarm limit, when the choice is ON, the alarm is activated; when the choice is OFF, the alarm sound will be forbidden, the alarm indicator will not light up and the relative alarm parameter will not flash.

## SPO2 ALARM HIGH

The SpO<sub>2</sub> alarm upper-limit. The range is 50~100 %. The factory setting is 99% and the single-step adjustable step-length is 1%.

## SPO2 ALARM LOW

The SpO<sub>2</sub> alarm lower-limit. The range is 50~100 %. The factory setting is 85%, and the single-step adjustable step-length is 1%.

## PR ALARM HIGH

The PR alarm upper-limit. The range is 30~239 bpm. The factory setting is 130 bpm, and the single-step adjustable step-length is 1 bpm.

## PR ALARM LOW

The PR alarm lower-limit. The range is 20~150 bpm. The factory setting is 50 bpm, and the single-step adjustable step-length is 1%.

## MEASUREMENT LIMITATIONS

1. The measurement is determined by the pulse of the blood flow in the arterial blood vessels. The arterial blood flow may decrease to such a level that it cannot be measured under the following conditions:
  - Shock
  - Hypothermia
  - Vasoactive medicines are applied
  - Anemia
2. The measurement is also determined by how well the oxyhemoglobin and reduced-hemoglobin absorb the light of the specific wave-length being used. If there are other substances that can absorb light of the same wave-length, they can cause the measurement to be inaccurate or lower than the actual value of SpO<sub>2</sub>. For example:
  - Carboxyhemoglobin
  - Methemoglobin
  - Methylene blue
  - Carmine indigo
3. Intense light in the environment can also influence measurement. Using a light-tight material to cover the sensor can improve the quality of the measurement.

### **[WARNING]**

- Prolonged and continuous monitoring may increase the chances of unexpected changes in dermal condition, like abnormal sensitivity, rubescence, vesicle, repressive putrescence, and so on. It is especially important with patients of poor perfusion or immature dermogram to check the sensor placement by light collimation and by re-attaching the sensor depending on the condition of the skin. Check the sensor placement regularly and move it when the skin deteriorates. More frequent examinations may be required for different patients.
- DO NOT use SpO<sub>2</sub> sensors during magnetic resonance imaging (MRI). Induced current could potentially cause burns. The sensor may affect the MRI image, and the MRI unit may affect the accuracy of the oximetry measurements.

**SPO2 ERROR MESSAGES**

PLETH Waveform may display messages as below:

<b>PROMPTS</b>	<b>EXPLANATION</b>
Search Too Long	Search-time of SpO <sub>2</sub> is too long.
Searching For Pulse. . .	Searching for pulse signal.
Sensor Off	Sensor has fallen off or the finger is not inserted in the finger-probe.
SpO <sub>2</sub> Com Error	SpO <sub>2</sub> board has communication error with the mainboard.

## MASIMO INFORMATION

### TRADEMARK AND LICENSING LABELS



### MASIMO PATENTS

Please refer to Masimo's website for detailed information.

Masimo Patents: [http:// www.masimo.com/patents.htm](http://www.masimo.com/patents.htm).

### NO IMPLIED LICENSE

Possession or purchase of this device does not convey any express or implied license to use the device with unauthorized sensors cables which would, alone, or in combination with this device, fall within the scope of one or more of the patents relating to this device.

### GENERAL

The CLEO with specified Masimo SpO<sub>2</sub> sensor is to be operated by, or under the supervision of, qualified personnel only. The manual, accessories, directions for use, all precautionary information, and specifications should be read before use.

### WARNINGS

- ♦ Pulse rate measurement is based on the optical detection of a peripheral flow pulse and therefore may not detect certain arrhythmias. So it should not be used as a replacement or substitute for ECG based arrhythmia analysis.
- ♦ CLEO Patient Monitor should be considered an early warning device. As a trend towards patient deoxygenation is indicated, blood samples should be analyzed by a laboratory co-oximeter to completely understand the patient's condition.
- ♦ Interfering Substances: Dyes or any substance containing dyes that change usual blood pigmentation may cause erroneous readings.
- ♦ SpO<sub>2</sub> is empirically calibrated in healthy adult volunteers with normal levels of carboxyhemoglobin(COHb) and methemoglobin(MetHb).
- ♦ If any measurement seems questionable, first check the patient's vital signs by alternate means and then check the CLEO monitor for proper functioning.
- ♦ SpO<sub>2</sub> is empirically calibrated in healthy adult volunteers with normal levels of carboxyhemoglobin (COHb) and methemoglobin (MetHb)

#### **Inaccurate SpO<sub>2</sub> readings may be caused by:**

- Improper sensor application and placement
- Elevated levels of COHb or MetHb: High levels of COHb or MetHb may occur with a seemingly normal SpO<sub>2</sub>. When elevated levels of COHb or MetHb are suspected, laboratory analysis (CO-Oximetry) of a blood sample should be performed.
- Elevated levels of bilirubin
- Elevated levels of dyshemoglobin
- Vasospastic disease, such as Raynaud's, and peripheral vascular disease
- Hemoglobinopathies and synthesis disorders such as thalassemias, Hb s, Hb c, sickle cell, etc.
- Hypocapnic or hypercapnic conditions
- Severe anemia

- Very low arterial perfusion
- Extreme motion artifact
- Abnormal venous pulsation or venous constriction
- Severe vasoconstriction or hypothermia
- Arterial catheters and intra-aortic balloon
- Intravascular dyes, such as indocyanine green or methylene blue
- Externally applied coloring and texture, such as nail polish, acrylic nails, glitter, etc.
- Birthmark(s), tattoos, skin discolorations, moisture on skin, deformed or abnormal fingers. etc.
- Skin color disorders

## CAUTIONS

- ◆ If SpO<sub>2</sub> values indicate hypoxemia, a laboratory blood sample should be taken to confirm the patient's condition.
- ◆ If the Low Perfusion message is frequently displayed, find a better perfused monitoring site. In the interim, assess the patient and, if indicated, verify oxygenation status through other means.
- ◆ Change the application site or replace the sensor and/or patient cable when a "Replace sensor" and/or "Replace patient cable", or a persistent poor signal quality message (such as "Low SIQ") is displayed on the CLEO<sup>®</sup> monitor. These messages may indicate that patient monitoring time is exhausted on the patient cable or sensor.
- ◆ If using CLEO monitor during full body irradiation, keep the sensor out of the radiation field. If the sensor is exposed to the radiation, the reading might be inaccurate or the device might read zero for the duration of the active irradiation period.
- ◆ To ensure that alarm limits are appropriate for the patient being monitored, check the limits each time the CLEO is used.
- ◆ Variation in measurements may be profound and may be affected by sampling technique as well as the patient's physiological conditions. Any results exhibiting inconsistency with the patient's clinical status should be repeated and/or supplemented with additional test data. Blood samples should be analyzed by laboratory instruments prior to clinical decision making to completely understand the patient's condition.
- ◆ Replace the cable or sensor when a replace sensor or when a low SIQ message is consistently displayed while monitoring consecutive patients after completing troubleshooting steps listed in this manual.

## NOTES

- ◆ A functional tester cannot be used to assess the accuracy of the CLEO monitor.
- ◆ High-intensity extreme lights (such as pulsating strobe lights) directed on the sensor, may not allow the CLEO monitor to obtain vital sign readings.
- ◆ When using the Maximum Sensitivity setting, performance of the "Sensor Off" detection may be compromised. If the device is in this setting and the sensor becomes dislodged from the patient, the potential for false readings may occur due to environmental "noise" such as light, vibration, and excessive air movement.
- ◆ Do not loop the patient cabling into a tight coil or wrap around the device, as this can damage the patient cabling.
- ◆ Additional information specific to the Masimo sensors compatible with the CLEO patient monitor, including information about parameter/measurement performance during motion and low perfusion, may be found in the sensor's directions for use (DFU).
- ◆ Cables and sensors are provided with X-Cal™ technology to minimize the risk of inaccurate readings and unanticipated loss of patient monitoring. Refer to the Cable or Sensor DFU for the specified duration of the patient monitoring time.

## MEASUREMENTS

**Incorrect measurements may be caused by:**

- Incorrect sensor application or use
- Significant levels of dysfunctional hemoglobins. (e.g., carboxyhemoglobin or methemoglobin)
- Intravascular dyes such as indocyanine green or methylene blue.
- Inyes, interfering Substances: DNail polish or any substance containing dyes that change usual blood pigmentation may cause erroneous readings.
- Exposure to excessive illumination, such as surgical lamps (especially long lamps, or direct sunlight (exposure to excessive illumination canes with a xenon light source), bilirubin lamps, fluorescent lights, infrared heatin be corrected by covering the sensor with a dark or opaque material)
- Excessive patient movement.
- SpO<sub>2</sub> is empirically calibrated to functional arterial oxygen saturation in healthy adult volunteers with normal levels of carboxyhemoglobin (COHb) and methemoglobin (MetHb). The monitor cannot measure elevated levels of COHb or MetHb. Increases in either COHb or MetHb will affect the accuracy of the SpO<sub>2</sub> measurement.
- Venous pulsations may cause erroneous low readings (e.g. tricuspid valve regurgitation).
- Patient suffers from abnormal pulse rhythm.
- Use only Masimo approved accessories.
- Motion artifact may lead to inaccurate measurements.
- Elevated levels of Total Bilirubin may lead to inaccurate SpO<sub>2</sub> measurements..
- With very low perfusion at the monitored site, the readings may read lower than core arterial oxygen saturation.
- Do not immerse the sensor or patient cable in water or, solvents, or cleaning solutions (The sensors and connectors are not waterproof).
- Placement of a sensor on an extremity with a blood pressure cuff, arterial catheter, or intravascular line.

**Loss of pulse signal can occur in any of the following situation:**

- The sensor is too tight.
- There is excessive illumination from light sources such as a surgical lamp, a bilirubin lamp, or sunlight.
- A blood pressure cuff is inflated on the same extremity as the one with a SpO<sub>2</sub> sensor attached.
- The patient has hypotension, severe vasoconstriction, severe anemia, or hypothermia.
- There is arterial occlusion proximal to the sensor.
- The patient is in cardiac arrest or is in shock.

**SENSORS**

- Use only Masimo oximetry sensors for SpO<sub>2</sub> measurements. Other oxygen transducers (sensors) may cause improper MS board performance.
- Tissue damage can be caused by incorrect application or use of a [Masimo sensor](#), for example by wrapping the sensor too tightly. Inspect the sensor site as directed in the sensor Directions for Use to ensure skin integrity and correct positioning and adhesion of the sensor.
- Do not use damaged [Masimo](#) sensors. Do not use a [Masimo](#) sensor with exposed optical components. Do not immerse the sensor in water, solvents, or cleaning solutions (the sensors and connectors are not waterproof). Do not sterilize by irradiation, steam, or ethylene oxide. See the cleaning instructions in the directions for use for reusable [Masimo](#) sensors.

The CLEO Patient Monitor with Masimo technology board is intended to be used with the following sensors:

For Human:

- Foam Wrap for M-LNCS Y1 Sensor

- M-LNCS™ DCI: Adult Finger Sensor
- M-LNCS™ DCIP: Pediatric Finger Sensor
- M-LNCS™ YI: Multisite Reusable Sensor
- M-LNCS™ Adtx Adhesive Sensors
- M-LNCS™ pdtx Adhesive Sensors
- M-LNCS™ Inf Adhesive Sensors
- M-LNCS™ Neo Adhesive Sensors
- M-LNC-10: 10 ft. Patient Cable

For Animal:

- M-LNCS™ TC-I AH, Reusable Animal Clip Sensor
- M-LNCS™ TF-I AH, Reusable Animal Transflectance Sensor
- M-LNCS™ YI AH, Reusable Animal Multisite Sensor
- M-LNC-10

Intentionally left blank

## NIBP MONITORING

- SUMMARY ON NIBP MONITORING
- NIBP CUFF FITTING
- NIBP MONITORING INITIALIZATION
- NIBP PARAMETER SETUP
- NIBP LIST OBSERVATION
- MEASUREMENT LIMITATIONS
- NIBP ERROR MESSAGES
- MAINTAINENCE AND CLEANING

### SUMMARY ON NIBP MONITORING

The Non-invasive Blood Pressure (NIBP) module measures the blood pressure using the oscillometric method.

It can be used on **Adult** patients.

There are three modes of measurement available: **Manual**, **Automatic** and **Stat**. Each mode displays the diastolic, systolic and mean blood pressure.

#### **[WARNING]**

- You must not perform NIBP measurements on patients with sickle-cell disease or any condition under which the skin is damaged or expected to be damaged.
- For a thrombasthenia patient, it is important to determine whether measurement of the blood pressure will be done automatically. This decision should be based on the clinical evaluation.
- Before starting a measurement, verify that you have selected a setting appropriate for your patient(adult only).
- DO NOT apply the cuff to a limb that has an intravenous infusion or catheter in place. This could cause tissue damage around the catheter when infusion is slowed or blocked during cuff inflation.

### NIBP CUFF FITTING

1. How well the blood pressure cuff fits the patient will influence the accuracy of the NIBP measurement. The cuff width recommend by the **AMERICA HEART SOCIETY** is 40% of upper arm circumference or 2/3 of the upper arm length.
2. Apply the blood pressure cuff to the patient's arm:
  - Make sure that the cuff is completely deflated.
  - Apply the appropriate size cuff to the patient, and make sure that the symbol "φ" is over the appropriate artery. Ensure that the cuff is not wrapped too tightly around the limb. Excessive tightness may cause discoloration and eventual isocheimal of the extremities.
3. Make sure that the cuff has not been twisted.
4. Insert the air hose into the **NIBP** socket on the left panel of monitor. Ensure that the spring block on the left side of socket has been pressed.

When inserting or unplugging the pipe, otherwise measurement process will be irregular and the sensor connector will be damaged.

**[WARNING]**

- The width of the cuff should be either 40% of the limb circumference 2/3 of the upper arm length. The inflatable part of the cuff should be long enough to encircle 50-80% of the limb. Using the wrong cuff size can cause erroneous readings. If you are unsure about which cuff size to use, use a larger cuff.
- Make sure that the cuff edge falls within the range of <-> . If does not, then change to a more suitable cuff.
- Connect the cuff to the air hose. The limb chosen for taking the measurement should be placed at the same level as the patient's heart. If this is not possible you should apply the following corrections to the measured values:
- If the cuff is placed higher than the heart level, add 0.9mmHg (0.12kPa) for each inch of difference.
- If it is placed lower than the heart level, deduct 0.9mmHg (0.12kPa) for each inch of difference.

**NIBP MONITORING INITIALIZATION**

After opening the host machine, check the information area of the screen before NIBP monitoring. If you see message "NIBP selfcheck OK!", then the NIBP module is working, and you can begin NIBP monitoring. Any NIBP monitoring taken before the information indicating is invalid; if you see "NIBP selfcheck error", then the NIBP module is not working. Press the **START/STOP** button to run the self-check or machine-open again. If the error persists, contact a servicing engineer.

**NIBP PARAMETER SETUP**

Touch the NIBP Parameter Area to open the NIBP Setup menu.

**Figure 8: Tree Diagram for NIBP Setup Menu**

This menu has the following settings:

**DISPLAY COLOR**

Choose from Yellow, White, Blue, Red, Green and Cyan. The default setting is Green.

**ALARM SWITCH**

**ON** and **OFF** for choice, the factory setting is **ON**.

If the NIBP value is above or below the NIBP alarm limit, and the settings are set to **ON**, then the alarm will be activated. When the settings are set to **OFF**, the alarm indicator will not light up; the corresponding alarm parameters will not flash.

### **PRESSURE UNIT**

**mmHg** or **kPa**, the factory setting is **mmHg**.

### **PATIENT TYPE**

#### **ADULT TYPE**

This setting applies to the **adult** mode. Inflate the cuff to the set Inflation Pressure 150/180/200 mmHg . If the NIBP value cannot be measured, then inflate the cuff for the second time, but note that the maximum pressure cannot exceed 297 mmHg (40 kPa). The factory setting is **ADULT TYPE**.

### **INFLATION MODE**

There are three choices: Manual, Auto and STAT.

#### **MANUAL MODE:**

Press the **START/STOP** button to begin inflation. The information area should read "Manual measuring... ". This shows that measurement is being taken.

Once the NIBP measurement is finished, NIBP parameter area will display the values and the information area will read "Manual measuring ended!", and the measurement process will have finished.

If the NIBP value cannot be measured, the NIBP parameter area will display any error messages and automatically attempt to take the measurement again up to three times. If the value still cannot be measured, the information area will read "RETRY OVER", and no more measurements will be taken.

During the measurement, press the **START/STOP** button again to stop the NIBP measurement process. The information area will read "Stop Manual measuring."

#### **AUTOMATIC MODE**

NIBP parameter area will display the countdown of "Auto measuring..." (Time Interval). Under this setting, the machine will continue re-measure NIBP at every time interval until the mode is changed.

If you start a measurement manually, the monitor will then continue automatically repeat NIBP measurements at the set time interval.

If the NIBP measurement is finished, the NIBP parameter area will display the values and the information indicating area will read "Auto measuring ended! ". The monitor will then continue automatically measuring until the mode is changed.

If the NIBP value cannot be measured, the NIBP parameter area will display some error messages and will attempt to take the measurement again up to three times. If the value still cannot be measured, the information area will read "RETRY OVER". And automatically continue to take measurements at every time interval until the mode is changed.

If the **START/STOP** button is pressed during any point in the countdown period, the

monitor will immediately begin a new measurement.

During the measurement, pressing the **START/STOP** button again will stop the current NIBP measurement, and the information area will read "Stop Auto measuring", but the monitor will continue to automatically take measurements at every time interval.

**[WARNING]**

Prolonged non-invasive blood pressure measurements in Auto mode may be associated with purport, isocheimal and neuropathy in the limb wearing the cuff. When monitoring a patient, examine the extremities of the limb frequently for normal color, warmth and sensitivity. If any abnormality is observed, stop the blood pressure measurements.

**STAT MODE**

In the stat mode, the monitor will measure NIBP three times without stopping and then will stop automatically. You can also press the **START/STOP** button to end the measurement manually.

Press the **START/STOP** button to begin inflation. The information area will display "STAT measuring..." to indicate that the measurement is being taken. Once the NIBP measurement has finished, the NIBP parameter area will display the values and the information area will read "STAT measuring ended".

If the NIBP value cannot be measured, the NIBP parameter area will display some error messages and automatically will attempt to take the measurement again up to three times. If the value still cannot be measured, the information area will read "RETRY OVER! ", **and no more measurements will be taken.**

During the measurement, if you press the **START/STOP** button again, the information area will read "Stop STAT measuring", and the monitor will stop the NIBP measurement.

**[NOTE]**

The measured value will be display on the NIBP parameter area for 240 minutes unless a new measurement is taken during this period. On the appropriate trend graph and trend table, the parameter will be included for the appropriate length of time.

**TIME INTERVAL**

This setting is used by the **automatic** inflation mode. You can input the time interval you want, as long as it is between 1 min to 4 hours.

## INFLATION OPTION

There are two options for setting.

### INFLATION MEMORY

When choosing “ON”, the monitor memorizes the latest blood pressure reading for same patient type or same patient ID, then the next measurement will begin with a Inflation Pressure same as the memorized blood pressure, if the patient type or patient ID is changed, the next measurement will begin with the setting Inflation Pressure. When choosing “Off”, the Inflation Pressure will begin with the one that had been set.

### INFLATION PRESSURE

This is to set the initial inflation pressure. When INFLATION MEMORY is “off”, the Inflation Pressure for a new measurement will always began with the setting inflation pressure.

**Inflation Pressure option is as below:**

Adult			Large Vet (Strong)	Small Vet (Strong)	Large/small Vet (SunTech)
150mmHg			150mmHg	100mmHg	160mmHg
180mmHg					
200mmHg					

## ALARM LIMIT SETUP

<i>Limits</i> <i>Patient Type</i>	<i>SYS UPPER LIMIT (mmHg)</i>	<i>SYS LOWER LIMIT (mmHg)</i>	<i>DIA UPPER LIMIT (mmHg)</i>	<i>DIA LOWER LIMIT (mmHg)</i>
<b>Adult</b>	30~240 Factory setting:150	30~240 Factory setting:100	15~180 Factory setting:90	15~180 Factory setting:50
<b>I</b>				

The alarm limit must be changed in increments of at least **1** mmHg.

## FACTORY SETUP

This function is for servicing engineer only.

## NIBP LIST OBSERVATION

Touch the “NIBP List” menu item to open the NIBP List Tabular.

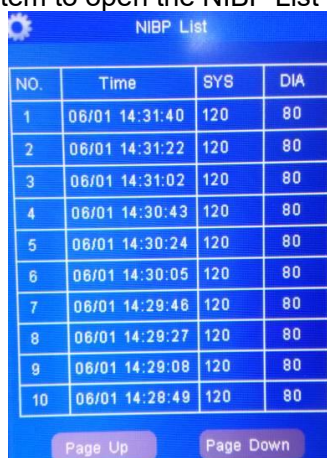

NO.	Time	SYS	DIA
1	06/01 14:31:40	120	80
2	06/01 14:31:22	120	80
3	06/01 14:31:02	120	80
4	06/01 14:30:43	120	80
5	06/01 14:30:24	120	80
6	06/01 14:30:05	120	80
7	06/01 14:29:46	120	80
8	06/01 14:29:27	120	80
9	06/01 14:29:08	120	80
10	06/01 14:28:49	120	80

**Figure 9: Window for NIBP List Observation**

The NIBP list can save 300 groups of data.

**[NOTE]:** Only after the NIBP value has been measured can it be added to the NIBP Data List. NIBP list can save up to 300 groups of data. If exceed, the new data will remove the oldest data from the list and be added to the list.

## MEASUREMENT LIMITATIONS

For certain patient conditions, the oscillometric measurement has certain limitations. The measurement must find regular arterial pressure. When the patient's condition makes it difficult to detect this pressure, the measurement will be unreliable and take longer to complete. In some cases, the patient's condition will make a measurement impossible. Such issues may arise under the following circumstances:

### PATIENT MOVEMENT

Measurements will be unreliable or impossible to take if the patient is moving, shivering or having convulsions. These motions may interfere with the detection of the pulses in arterial pressure and increase the time needed to take the measurement.

### CARDIAC ARRHYTHMIA'S

Measurements will be unreliable or impossible to take if the patient's cardiac arrhythmia has caused an irregular heartbeat. It will also take longer to take the measurement.

### HEART-LUNG MACHINE

It will not be possible to take measurements if the patient is connected to a heart-lung machine.

### PRESSURE CHANGES

Measurements will be unreliable or impossible to take if the patient's blood pressure is changing rapidly while the measurement is being taken.

### SEVERE SHOCK

If the patient is in severe shock or hypothermia, measurements will be unreliable since reduced blood flow to the peripheries will cause reduced pulsation of the arteries.

### HEART RATE EXTREMES

Measurements cannot be made if the patient's heart rate is less than 40 bpm or greater than 240 bpm.

## NIBP ERROR MESSAGES

Message area may display messages like the following:

Patient moving!	Serial error
Pressure < 10 mmHg!	NIBP renew self-check...
Pressure < 1.3 kPa!	NIBP self-check...
Pressure > 325 mmHg!	NIBP self-check error!
Pressure > 43.3 kPa!	NIBP inter error!
Serial overtime!	Patient type error!
Reset error!	Setup patient...
Zero reset error!	NIBP self-check ok!

## MAINTAINENCE AND CLEANING

**[NOTE]**  
DO NOT squeeze the rubber tube on the cuff.

## REUSABLE BLOOD PRESSURE CUFF

The cuff can be sterilized with conventional autoclaving, gas or radiation sterilization in hot air ovens, or by being submerged in decontamination solutions. If you use this last method, remember to remove the rubber bag. The cuff should not be dry-cleaned. The cuff can be machine-washed or hand-washed; hand washing may prolong the service life of the cuff. Before washing, remove the latex rubber bag, and for machine-washing, close the Velcro fastening. Allow the cuff to dry thoroughly after washing, and then reinsert the rubber bag.

Replace the bladder after cleaning and disinfecting the cuff, the method is as follows:

1. Place the bladder on the top of the cuff, as the figure shows.
2. Roll the bladder lengthwise and insert it into the large opening.
3. Hold the hose and the cuff and shake the complete cuff until the bladder is in position.
4. Thread the hose from inside the cuff, and out through the small hole under the internal flap.

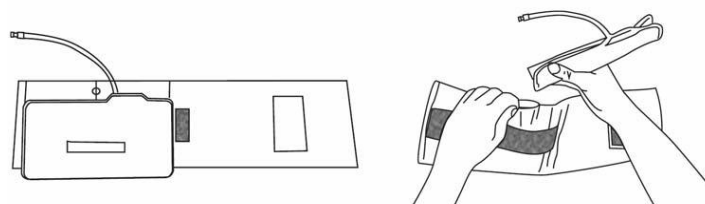

**Figure 10: Sketch Map for Replacing the Bladder**

## QUICK TEMP MONITORING

- ABOUT BODY TEMPERATURES
- GENERAL INFORMATION
- SAFETY AND WARNING
- INSTRUCTION FOR USE
- QTEMP PARAMETER SETUP
- MAINTAINENCE AND CLEANING

### ABOUT BODY TEMPERATURES

It is a common myth that 98.6°F (37°C) is the “normal body temperature.” The truth is that 98.6°F (37°C) is an average body temperature. Normal body temperature varies with age, gender, and measurement site. Body temperatures also fluctuates throughout the day, typically cooler temperatures in the morning, warmer in the afternoon, and cooling down again in the evening. Other factors that can influence body temperature: the patient's recent level of activity, metabolism rate, or medications. Normal body temperatures also tend to decrease with age.

Please see the chart below for normal temperature ranges by patient age and site. Readings from different body sites, even when taken at the same time, should not be directly compared; body temperatures will vary by site.

Temperature Site	Normal Body Temperatures by Patients Age			
	0-2 Years	3-10 Years	11-65 Years	>65 Years
Ear	97.5°-100.4°F 36.4°-38.0°C	97.0°-100.0°F 36.1°-37.8°C	96.6°-99.7°F 35.9°-37.6°C	96.4°-99.5°F 35.8°-37.5°C
Oral	- -	95.9°-99.5°F 35.5°-37.5°C	97.6°-99.6°F 36.4°-37.6°C	96.4°-98.5°F 35.8°-36.9°C
Core	97.5°-100.0°F 36.4°-37.8°C	97.5°-100.0°F 36.4°-37.8°C	98.2°-100.2°F 36.8°-37.9°C	96.6°-98.8°F 35.9°-37.1°C
Rectal	97.9°-100.4°F 36.6°-38.0°C	97.9°-100.4°F 36.5°-38.0°C	98.6°-100.6°F 37.0°-38.1°C	97.1°-99.2° 36.2°-37.3°C
Axillary	94.5°-99.1°F 34.7°-37.3°C	96.6°-98.0°F 35.9°-36.7°C	95.3°-98.4°F 35.2°-36.9°C	96.0°-97.4°F 35.6°-36.3°C

**Figure 11: Temperature Site and Patient Age**

### GENERAL INFORMATION

1. The FILACTM 3000 electronic thermometer is a fast, highly accurate and easy to use clinical instrument for measuring patient temperatures by Oral, Axillary or Rectal means.
2. The electromagnetic compatibility of this device has been verified by test according to the EN60601-1-2: 2005 requirements.
3. This device requires no user maintenance other than periodic cleaning and replacement of expired batteries.

**[CAUTION]:** Federal law (USA) restricts this device to sale by or on the order of a physician.

## SAFETY AND WARNING

1. Read this booklet thoroughly before using the FILAC 3000 electronic thermometer.
2. Do not use this device near flammable anesthetics. Not suitable for use in the presence of flammable anesthetic mixture with air, oxygen or nitrous oxide.
3. Do not use this thermometer without first installing a new FILAC 3000 electronic thermometer probe cover.
4. Use only FILAC 3000 electronic thermometer probe covers with this device. Use of any other probe cover will result in erroneous temperature readings.
5. The device and probe covers are Non-sterile. Do not use on abraded tissue.
6. To limit cross contamination, use Blue devices for Oral and Axillary temperature taking only.
7. Use RED devices only for RECTAL temperatures.
8. Thoroughly dry all electrical contacts on both probe and thermometer after washing, or device may fail to function properly.
9. For re-calibration, service or integrity checks, refer to a qualified Biomedical Technician or return to manufacturer.
10. Do not open unit. No user-serviceable parts inside. Opening of device may affect calibration and voids warranty.
11. Disposal of used probe covers must be performed in accordance with current medical practices or local regulations regarding disposal of infectious, biological medical waste.
12. Removal of the batteries is recommended if the unit is not going to be used for an extended period of time.
13. Dispose of batteries in a manner consistent with local environmental and institutional policy for Lithium or Alkaline battery disposal.
14. Dispose of old battery-powered electronic equipment in a manner consistent with institutional policy for expired equipment disposal.
15. Cleaning frequency and practices must be consistent with institutional policy for cleaning of non-sterile devices.
16. Device to be used by trained personnel.

### **[NOTE]:**

Even though this device has been designed to minimize the effects of electromagnetic interference, it does generate radio frequency energy. If not used in accordance with the instructions, the device could cause interference in other equipment operating within its vicinity. If the device is causing interference, the following actions may be taken in an attempt to correct the interference:

- Re-orient or re-locate the receiving device.
- Increase the separation between the devices.
- Consult a customer service representative.

## INSTRUCTION FOR USE

### **Probe Covers —Applying & Removing**

1. Open probe cover box by lifting tab at top corner and pulling to remove top panel.
2. Insert box of probe covers into top of isolation chamber. (To aid infection control, never switch boxes between blue and red isolation chambers. Also, never switch probes between blue and red isolation chambers. Keep like colors together.)
3. Remove probe from the probe well. This automatically turns on the thermometer.
4. To help remind the user to apply or remove a probe cover, a probe icon with flashing probe cover will be displayed when the probe is withdrawn from the probe well and following a completed temperature measurement.

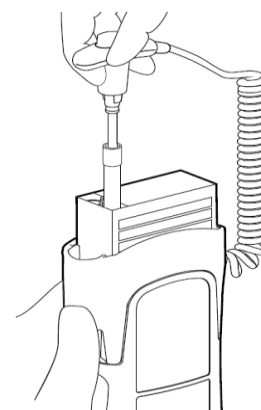

5. Insert the probe end into a cover in the box. Push the handle firmly until you feel the cover "snap" into place.
6. Take appropriate temperature measurement (oral, axillary or rectal).
7. Eject the used cover into bio-waste container by pressing top button.
8. Remove, discard and replace box when empty.

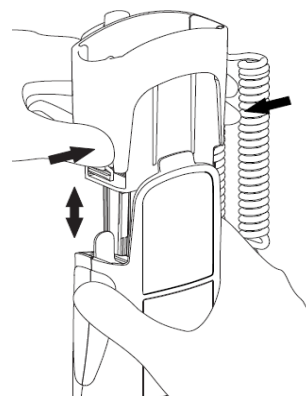

### **Changing Isolation Chambers and Probes**

1. For aiding in infection control, use only the Blue probe and Blue isolation chamber for Oral and Axillary temperature taking. The Red probe and Red isolation chamber must only be used for rectal temperature taking.
2. Do not attach a Red probe to a Blue isolation chamber or vice-versa.
3. To remove or replace any isolation chamber/probe assembly, grasp the isolation chamber from each side as shown.
4. Squeeze inward releasing the snaps and slide the isolation chamber up to pull off.
5. To replace, align probe well finger with opening in the top of the unit.
6. Slide the isolation chamber down until the side snaps "click" into place.
7. The probe is connected to the thermometer automatically.
8. To change probes, remove the isolation chamber as described previously.
9. Grasp the sides of the L-shaped connector piece with one hand and then using other hand pull backward on the latch holding the end of the L-shaped connector.
10. Once free of the latch, slide the L-shaped connector out of isolation chamber.
11. To replace, properly align the top of the L-shaped connector to the slot on the back of the isolation chamber.
12. Then slide the connector up into the slot pressing firmly on the bottom of the connector until it "clicks" into place.

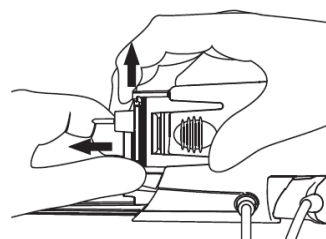
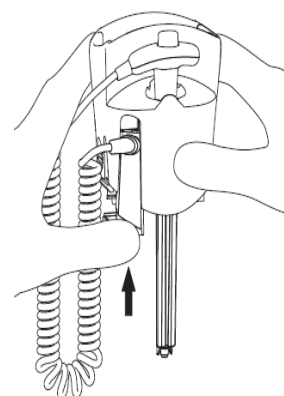

### **Oral & Axillary Temperature Taking**

1. Make certain that the Blue isolation chamber/probe unit is attached.
2. Withdraw probe and apply a probe cover. The thermometer turns on automatically.
3. An icon identifying Oral or Axillary mode is displayed. The Rectal icon cannot be displayed when a blue isolation chamber/probe is attached.
4. Press the Site button on the front panel to select either the Oral or Axillary mode.
5. For Oral temperatures, insert the probe tip deep into the sublingual pocket next to the frenulum linguae, (vertical fold of tissue in middle of tongue), on one side or the other, toward the back of the mouth.

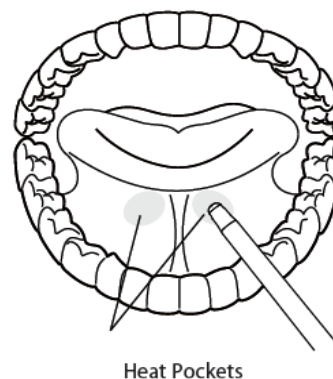

**[NOTE]**

Accurate body temperature readings can only be obtained in one of these two "heat pocket" locations as shown. Temperatures taken in other mouth locations will result in inaccurate body temperature readings

6. Patient's mouth must be CLOSED.
7. Securely hold the probe in place until the temperature is displayed.\*
8. For Axillary temperatures, have the patient raise the arm, then place the probe tip in the axilla. Press gently to assure good contact. For the most accurate temperature the probe tip should be placed directly against the patient's skin.
9. Have the patient then lower the arm and remain as still as possible.\* Hold the probe parallel to the arm as shown.
10. If two short beeps are heard, it means the unit switched to Direct (slow) mode for this temperature only.
11. A "long beep" is sounded when measurement is complete and the final temperature is displayed.
12. To change between Celsius and Fahrenheit scales, press the °C/°F button. Press again as needed.
13. Eject the used cover into a bio-waste container by pushing top button.
14. After returning the probe to the probe well, the temperature is stored for recall until the probe is once again withdrawn. If the probe is returned to the probe well before the "long beep" is heard, no temperature will be stored for the recall function.

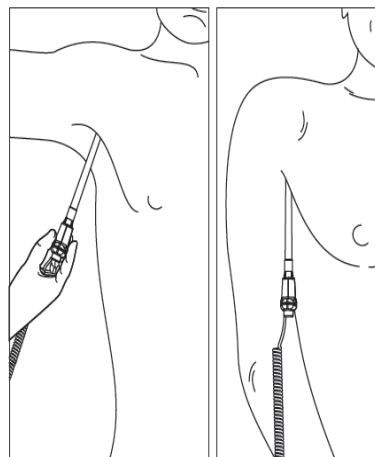
**Rectal Temperature Taking**

1. Make certain that the Red isolation chamber/probe unit is attached.
2. Withdraw the probe and apply a probe cover. Thermometer turns on automatically.
3. An icon identifying rectal mode is always displayed provided the Red isolation chamber/probe assembly is attached. Pressing the Site button on the front panel to change modes has no effect.
4. Apply lubrication if desired.
5. Insert the probe into the patient's rectum. To ensure proper tissue contact, angle the probe slightly after insertion.<sup>1)</sup>
6. Depth of insertion is recommended at 1/2" to 3/4" (12 mm - 19 mm) for adults and 1/4" to 1/2" (6 mm - 13 mm) for children.
7. If two short beeps are heard, it means the unit switched to Direct (slow) mode for this temperature only.
8. A "long beep" is sounded when measurement is complete and the final temperature is displayed.
9. To change between Celsius and Fahrenheit scales, press the °C/°F button. Press again as needed.
10. Eject the used cover into a bio-waste container by pushing top button.
11. After returning the probe to the probe well, the temperature is stored for recall until the probe is once again withdrawn. If the probe is returned to the probe well before the "long beep" is heard, no temperature will be stored for the recall function.

**[NOTE]:** Probe movement during a measurement can affect the thermometer's ability to measure the site temperature and may lengthen the time required to obtain a reading.

**Direct Mode**

1. The FILAC 3000 electronic thermometer normally operates in Predictive Mode to provide fast and accurate temperature measurements. However, in instances when no measurement site is detected or the temperature does not stabilize, the thermometer will automatically switch to Direct Mode and act as a temperature monitor.
2. Additionally, the FILAC 3000 electronic thermometer will automatically switch into Direct Mode if the ambient temperature is greater than 35°C (95°F).
3. The FILAC 3000 electronic thermometer can be set to operate exclusively in Direct Mode (disable Predictive Mode). See instructions within the Bio-Tech Mode section for information on how to lock Direct Mode on.
4. A turtle icon will be continuously displayed whenever the thermometer is functioning in Direct Mode.
5. To change between Celsius and Fahrenheit scales, press and release the °C/°F button. Press and release again as needed.
6. An Up or Down arrow will appear on the display whenever the current temperature reading is out of range, either High or Low, respectively.
7. The Direct Mode auto feature is always functional regardless of Red or Blue isolation chamber/ probe.
8. A "long beep" is sounded when measurement is complete and the final temperature is displayed.
9. After returning the probe to the probe well, the temperature is stored for recall until the probe is once again withdrawn. If the probe is returned to the probe well before the "long beep" is heard, no temperature will be stored for the recall function.

**Quick Mode (Oral and Rectal)**

1. Quick Mode is an oral predictive measurement mode intended for situations where fast temperature measurements are desired.
2. Quick Mode allows clinicians to rapidly identify patients with "normal" body temperatures. If the patient temperature is outside of the "normal" range, the FILAC 3000 electronic thermometer will automatically switch into its standard predictive mode to provide a more accurate reading.
3. Quick Mode is indicated by a rabbit icon on the display. See instructions within the Bio-Tech Mode section for information on how turn this feature ON or OFF.
4. Quick Mode is not available when in Cold Mode or in Direct Mode.

**Cold Mode**

1. Cold Mode is provided for use in applications where body temperatures may be lower than "normal", such as for patients recently out of surgery.
2. See instructions within the Bio-Tech Mode section for information on how turn this feature ON or OFF.
3. When selected, as indicated by the snowflake on the display, the probe preheats to 33°C (91°F).
4. The accuracy and measurement time of Cold Mode measurements are equivalent to standard prediction measurements at the respective body sites.

**Recall Last Temperature**

1. After each temperature measurement, a "long beep" is heard. The "beep" indicates the temperature measurement has been completed and stored and is available for recall. This temperature can be recalled after the probe is returned to the probe well.
2. To recall the most recent temperature measurement, press and release °C/°F button on the front panel. The last measurement taken will appear for several seconds.
3. While the recalled measurement is displayed, the user may press and release

- the °C/°F button again to change between the Celsius and Fahrenheit scales.
4. Withdrawing the probe from the probe well erases last temperature memory.
  5. If the most recent temperature measurement was incomplete or out of range, dashes will appear on the display during the recall operation.

### **Pulse Timer Mode**

1. The FILAC 3000 electronic thermometer may also be used to help measure a patient's pulse rate.
2. To access, do not remove probe from the probe well.
3. Press and release the Timer button on the front panel. The Clock icon and 0.0 will be displayed.
4. Press and release the Timer button a second time to start the timer and elapsed time display.
5. A "beep" is sounded at 15 seconds, 2 beeps at 30 seconds, 1 beep at 45 seconds and 2 beeps at 60 seconds. The count stops at 60 seconds. Pressing the Timer button again will shut the unit off.
6. The Timer mode will turn off automatically, 5 seconds after stopping at 30 or whenever the probe is removed from the probe well.

### **Bio-Tech Mode (Option Configuration Menu)**

1. To enter Bio-Tech Mode, the thermometer must be in sleep mode (probe securely in place with blank screen).
2. Press and hold the Site and °C/°F buttons at the same time for 4 seconds. A "beep" is heard and a dash scrolls in the display. The software version of the device will be shown in the alpha-numeric section of the display.
3. The thermometer is now in Bio-Tech Mode. To navigate the Bio-Tech Mode menu, follow the chart below.
4. The Pulse Timer button is used to move forward through the different configuration options. °C/°F button is used to change an option configuration.
5. To exit Bio-Tech Mode and resume normal operation, press the Site and °C/°F buttons at the same time and hold for 1 full second. Last settings are saved.
6. Bio-Tech Mode also exits automatically after 20 seconds of inactivity. The last settings are saved.

### **QTEMP PARAMETER SETUP**

Touch the QTemp Parameter Area to open the QTemp Setup menu, which is laid out as below:

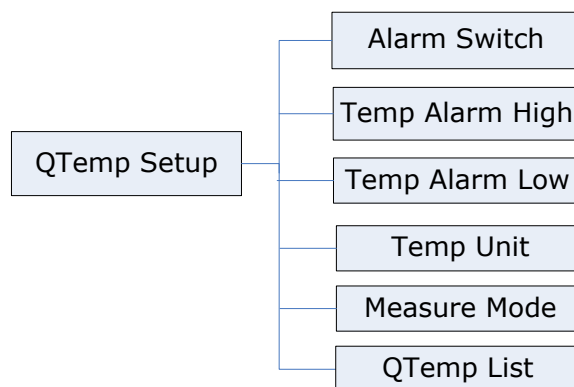

**Figure 12: Tree Diagram for QTemp Setup Menu**

The menu has the following settings:

#### **ALARM SWITCH**

**ON** or **OFF** can be chosen. The factory setting is **ON**.

If the QTemp value is above or below the QTemp alarm limit, and the alarm is ON, then the alarm will be activated. When the alarm is OFF, the alarm indicator will not light up; the corresponding alarm parameter will not flash.

### QTEMP ALARM HIGH

The QTemp alarm upper-limit range is **10~50°C (50~122 °F)**, and the factory setting is **40.0°C (104.0°F)**. The temperature can be adjusted in increments of **0.1°C (0.1°F)**.

### QTEMP ALARM LOW

The QTemp alarm lower-limit range is **10~50°C (50~122 °F)**, and the factory setting is **23°C (73.4°F)**. The temperature can be adjusted in increments of **0.1°C (0.1°F)**.

### QTEMP UNIT

Fahrenheit or Celsius can be chosen. The factory setting is Celsius.

### MEASURE MODE

It provides nine measure modes as choice including Oral Fast, Oral Standard, Oral Cold, Oral Direct, Oral Monitoring, Axillary Standard, Axillary Cold, Axillary Direct and Axillary Monitoring.

### QTEMP LIST OBSERVATION

Touch the "QTemp List" menu item to open the QTemp list Tabular.

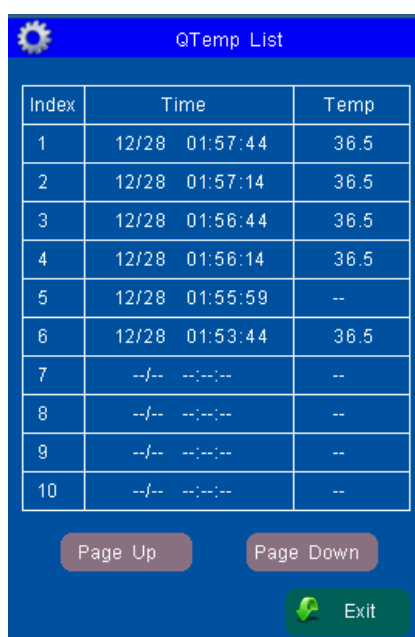

Index	Time	Temp
1	12/28 01:57:44	36.5
2	12/28 01:57:14	36.5
3	12/28 01:56:44	36.5
4	12/28 01:56:14	36.5
5	12/28 01:55:59	--
6	12/28 01:53:44	36.5
7	--/-- --:--:--	--
8	--/-- --:--:--	--
9	--/-- --:--:--	--
10	--/-- --:--:--	--

**Figure 13: Window for QTemp List Observation**

The QTemp list can save 300 groups of data.

**[NOTE]:** Only after the QTemp value has been measured successfully can it be added to the QTemp Data List. QTemp list can save up to 300 groups of data. If exceed, the new data will remove the oldest data from the list and be added to the list.

## **MAINTAINENCE AND CLEANING**

1. The entire device may be easily wiped clean. Water temperature should not exceed 130° F (55° C). Do not submerge or soak under water.
2. A mild detergent may be added to water. Use of cleaners such as Spray Nine™, PhisoHex™, Hibiclens™, or Vesta-Syde™ Cidex™ may result in damage to the thermometer case.
3. Use of 10:1 water and hypochlorite mixture or a damp isopropyl alcohol wipe occasionally, is acceptable. Prolonged and repeated use of these chemicals may result in damage to the thermometer case and display area.
4. Use of a cloth or sponge is recommended for cleaning. Abrasive pads may result in damage to the thermometer case and display area.
5. This thermometer is provided non-sterile. DO NOT use ethylene oxide gas, heat, autoclave, or any other harsh methods to sterilize this unit.
6. Isolation chambers may be replaced inexpensively instead of cleaning.
7. After cleaning the unit, shake the probe handle to drain out any excess solution. Thoroughly dry the electrical contacts on both probe and thermometer.

## ETCO<sub>2</sub> MONITORING

- THEORY OF OPERATION
- WARNINGS, CAUTIONS, NOTES
- ABBREVIATIONS AND TERMINOLOGY
- ZEROING THE CO<sub>2</sub> MODULE
- PATIENT AND TUBING PREPARATION
- ETCO<sub>2</sub> WAVEFORM SETUP
- ETCO<sub>2</sub> PARAMETER SETUP
- ADVANCED SETUP
- CALIBRATION
- STATUS/ERROR MESSAGES
- MAINTENANCE AND CLEACING

### THEORY OF OPERATION

Carbon dioxide monitoring system is a sidestream sampling system with a 50 ml/minute low sampling rate, which is used to monitor continuous carbon dioxide and display the End Tidal carbon dioxide (EtCO<sub>2</sub>), inspired CO<sub>2</sub> and respiratory rate values of the non-intubated and intubated adult patient, using specially designed sampling cannula and on-airway adapter kits. These kits incorporate a filter and the sample cell that provides maximum filtration of fluids and contaminants and protects the system from aspiration of these fluids.

In carbon dioxide monitoring system, infrared light is generated by the sensor and beamed through the sample cell to a detector on the opposite side. CO<sub>2</sub> from the patient that is aspirated into the sample cell absorbs some of this infrared energy. The monitor determines CO<sub>2</sub> concentration in the breathing gases by measuring the amount of light absorbed by these gases. EtCO<sub>2</sub> is displayed as a numerical value in millimeters of mercury (mmHg), percent (%), or kilopascals (kPa). In addition, a CO<sub>2</sub> waveform (capnogram) may be displayed which is a valuable clinical tool that can be used to assess patient airway integrity and proper endotracheal tube (ETT) placement. Respiration rate is calculated by measuring the time interval between detected breaths.

### WARNINGS, CAUTIONS AND NOTES

#### WARNINGS

- ◆ Explosion Hazard: DO NOT use in the presence of flammable anesthetics or other flammable gasses.
- ◆ Electrical Shock Hazard: Always disconnect the CO<sub>2</sub> module before cleaning. DO NOT use if it appears to have been damaged. Refer servicing to qualified service personnel.
- ◆ Failure of Operation: If the CO<sub>2</sub> module fails to respond as described in this user manual; DO NOT use it until approved for use by qualified personnel.
- ◆ DO NOT position the sensor cables or tubing in any manner that may cause entanglement or strangulation. Support the carbon dioxide monitoring system airway adapter to prevent stress on the ET tube.
- ◆ Reuse, disassembly, cleaning, disinfecting or sterilizing the single patient use cannula kits and on-airway adapters may compromise functionality and system performance leading to a user or patient hazard. Performance is not guaranteed if an item labeled as single patient use is reused.
- ◆ Inspect the sidestream on-airway adapters and sidestream sampling kits for damage prior to use. DO NOT use the sidestream on-airway adapters and sidestream sampling kits if they appear to be damaged or broken.
- ◆ Replace the sidestream on-airway adapters and sidestream sampling kits if excessive secretions are observed.
- ◆ Monitor the CO<sub>2</sub> check waveform (Capnogram). If you see changes or abnormal

- appearance the patient and the sampling line. Replace line if needed.
- ◆ DO NOT operate the CO<sub>2</sub> Module when it is wet or has exterior condensation.
  - ◆ DO NOT apply excessive tension to any cable.
  - ◆ DO NOT use device on patients that cannot tolerate the withdrawal of 50 ml/min +/- 10 ml/min from the airway or patients that cannot tolerate the added dead space to the airway.
  - ◆ DO NOT connect the exhaust tube to the ventilator circuit.

### CAUTIONS

- ◆ DO NOT sterilize or immerse the CO<sub>2</sub> module in liquids.
- ◆ DO NOT store the CO<sub>2</sub> Module at temperatures less than -40° F (-40° C) or greater than 158° F (70° C).
- ◆ DO NOT operate the CO<sub>2</sub> Module at temperatures less than 32° F (0° C) or greater than 104° F (40° C).
- ◆ DO NOT stick appendage into sample receptacle.
- ◆ Always insert sample cell before inserting the on-airway adapter into the ventilated circuit.
- ◆ Always remove the on-airway adapter from the ventilated circuit before removing the sample cell.
- ◆ Nitrous oxide, elevated levels of oxygen, helium, Xenon, halogenated hydrocarbons, and barometric pressure can influence the CO<sub>2</sub> measurement. Levels to be supplied by the monitor.

### NOTES

- ◆ The CO<sub>2</sub> module and its accessories are latex free.
- ◆ After the life cycle of the CO<sub>2</sub> module and its accessories has been met, disposal should be accomplished following national and/ or local requirements.

### ABBREVIATIONS AND TERMINOLOGY

EtCO <sub>2</sub>	End tidal carbon dioxide
INSP CO <sub>2</sub>	Inspired minimum CO <sub>2</sub>
AWRR	Air-way respiration rate
BARO	Barometric Pressure

### ZEROING THE CO<sub>2</sub> MODULE

The sample cell zero allows the CO<sub>2</sub> Module to adjust to the optical characteristics of the sample cell only when requested.

For optimal accuracy, a CO<sub>2</sub> Module zero should be performed whenever the CO<sub>2</sub> Module is connected to the patient monitor.

Before performing a CO<sub>2</sub> Module zero, the CO<sub>2</sub> Module should be removed from the patient monitor and the airway adapter type to be used in the circuit should be inserted into the CO<sub>2</sub> Module. Care should be taken ensure that the airway adapter is clear of any residual CO<sub>2</sub> gas. The maximum elapsed time for a CO<sub>2</sub> Module zero is 30 seconds. The typical time for a zero is 15 – 20 seconds.

Several CO<sub>2</sub> Module conditions may also request that a zero be performed. These requests stem from changes in the airway adapter that may indicate that the sensor is not in optimal measuring condition. When this occurs, the airway adapter should be checked to ensure optical occlusions such as mucus have not obscured the adapter window. If occlusions are found, the airway adapter should be cleaned or replaced.

### NOTES:

- ◆ System does not allow adapter zero for 20 seconds after the last breath is detected.
- ◆ System does not allow adapter zero if temperature is not stable.

- ◆ An adapter zero cannot be performed if a sample cell is not connected to the module.
- ◆ For best results, wait 5 minutes to allow the CO<sub>2</sub> module to warm up before performing the Sample Cell Zero procedure.

## PATIENT AND TUBING PREPARATION

### MODULE MOUNTING

- Put the CO<sub>2</sub> module into the bracket of the rear panel of the monitor.
- Check that monitor is switched off, Insert the plug of CO<sub>2</sub> sensor into the corresponding sensor socket marked with **EtCO<sub>2</sub>** icon on the left panel of monitor.

**[WARNING]:** Don't hot plug EtCO<sub>2</sub> module, that is make sure that the CLEO is powered off before Insert the connector of CO<sub>2</sub> sensor into EtCO<sub>2</sub> socket. Otherwise the CO<sub>2</sub> module may be damaged by power supply from EtCO<sub>2</sub> socket of CLEO.

### CONNECTING THE SAMPLE KIT

- The sample cell of the sampling kit must be inserted into the sample cell receptacle of the CO<sub>2</sub> Module as shown in following figure. A "click" will be heard when the sample cell is properly inserted.

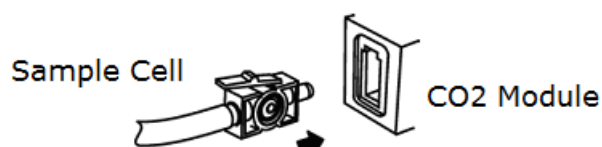

- Connect the CO<sub>2</sub> tubing to Nasal and Nasal/Oral Sidestream Kits.
- Inserting the sample cell into the receptacle automatically starts the sampling pump. Removal of the sample cell turns the sample pump off.
- To remove the sampling kit sample cell from the sample cell receptacle, press down on the locking tab and pull the sample cell from the sample cell receptacle.

## DIRECTIONS

### For use of single patient use nasal and nasal/oral sidestream kits

**CAUTION:** The Nasal and Nasal/Oral Cannula kits are intended for single patient use. Do NOT reuse or sterilize the cannula kit as system performance will be compromised.

- Verify that the cannula kit is clean, dry and undamaged. Replace the cannula kit if necessary.
- Insert the sample cell into the sample cell receptacle as shown in above figure on connecting the Sample Kit section. A "click" will be heard when properly inserted.
- Perform a sample cell zero if prompted by the host system.
- Place the nasal cannula kits onto the patient as shown in following figure.

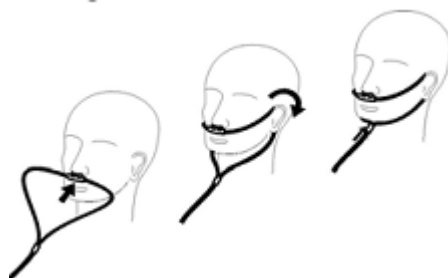

- Some patients are prone to mouth breathing. The Oral/Nasal sampling cannula should be used on these patients, as most, if not all, of the CO<sub>2</sub> is exhaled through

the mouth. If a standard nasal CO<sub>2</sub> sampling cannula is used with these patients, the EtCO<sub>2</sub> number and capnogram will be substantially lower than actual.

6. When using the Nasal or Oral/Nasal CO<sub>2</sub> sampling kits with oxygen delivery, place the cannula on the patient as shown above and then attach the oxygen supply tubing to the oxygen delivery system and set the prescribed oxygen flow.
7. If the oral/nasal cannula is used, the oral sampling tip may need to be trimmed to adequately fit the patient (see following figure). Place the cannula onto the patient as shown in above figure. Observe the length of the oral cannula tip. It should extend down past the teeth and be positioned in the mouth opening. Remove the cannula from the patient if the tip needs to be trimmed.



**[CAUTION]:**

- DO NOT cut the oral cannula tip when the cannula is on the patient.
- Remove the sampling kit sample cell from the CO<sub>2</sub> Module Inlet Port when not been use.

:

## FLOW RATE

Conditions that can cause a change in Flow Rate:

- Water, mucous, or other patient contaminate has entered the sample tubing.
- The sample tubing is crimped or pinched so that the sample flow rate has decreased.
- The exhaust port of the CO<sub>2</sub> module is obstructed.
- The sample line is damaged.
- The sample line has been cut, or split, causing the flow rate to increase.

## ETCO<sub>2</sub> WAVEFORM SETUP

Touch the EtCO<sub>2</sub> Waveform Area to open the EtCO<sub>2</sub> Waveform Setup menu, see graph below:

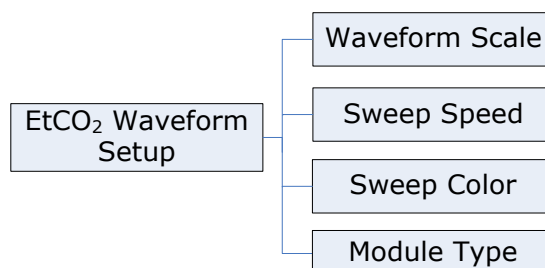

**Figure 14: Tree Diagram for EtCO<sub>2</sub> Waveform Setup Menu**

### WAVEFORM SCALE

Use this setting to adjust the amplitude measurement (size) of the displayed EtCO<sub>2</sub> waveform scale manually. The label will be displayed in the screen.

There are two items for choice: 0~75 mmHg, 0~150 mmHg.

### SWEEP SPEED

From 6.25 mm/s, 12.5 mm/s and 25 mm/s for choice, the factory setting is 6.25 mm/s.

### SWEEP COLOR

From Yellow, White, Blue, Red, Green and Cyan for choice, the default setting is Cyan.

### MODULE TYPE

There are two items for choice: External, Internal.

External means you could use external EtCO<sub>2</sub> module only. Internal means you could use internal EtCO<sub>2</sub> module only.

### ETCO2 PARAMETER SETUP

Touch the EtCO<sub>2</sub> Parameter Area to open the EtCO<sub>2</sub> Parameter Setup menu, see tree diagram below:

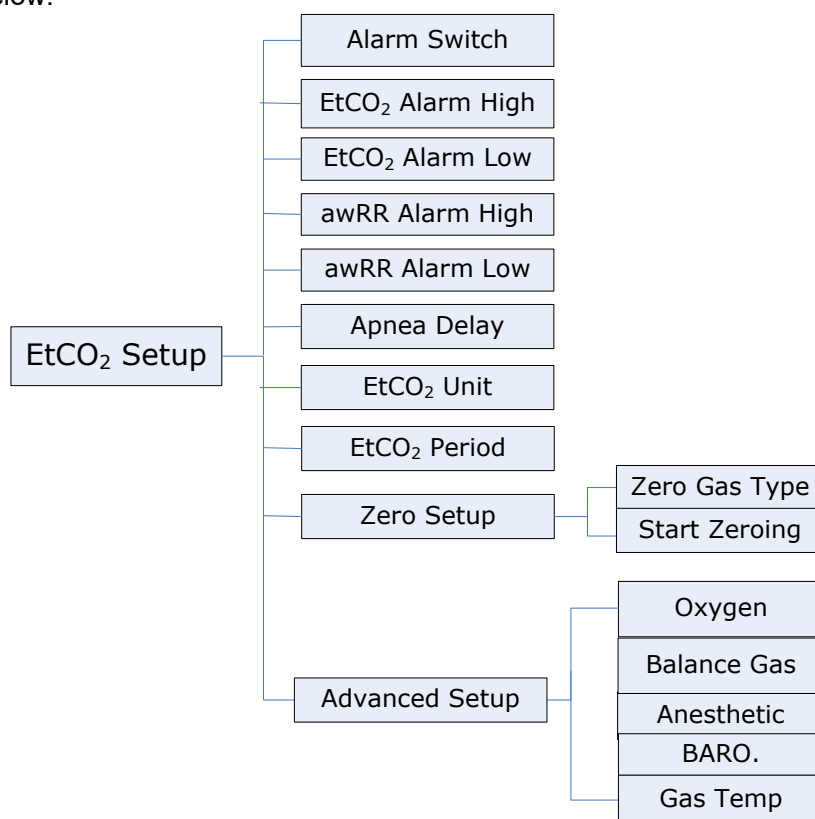

**Figure 15: Tree Diagram for EtCO<sub>2</sub> Parameter Setup Menu**

### ALARM SWITCH

**ON** and **OFF** for choice, the factory setting is **ON**.

If the EtCO<sub>2</sub> or awRR value is above or below the alarm limit, when the choice is ON, the alarm is activated; when the choice is OFF, the alarm sound will be forbidden, the alarm indicator will not light and the relative alarm parameter will not flash.

### ETCO2 ALARM HIGH

The range is 20~100 mmHg, and the factory setting is 60 mmHg.

### ETCO2 ALARM LOW

The range is 1~95 mmHg, and the factory setting is 15 mmHg.

### AWRR ALARM HIGH

The range is 10~150 mmHg, and the factory setting is 30 mmHg.

### AWRR ALARM LOW

The range is 5~100 mmHg, and the factory setting is 5 mmHg.  
The single-step adjustable length of alarm limit above is 1 mmHg.

### ASPHYXIA DELAY

This setting is used to set the no breaths detected time-out. This time-out is the time period in seconds following the last detected breath at which the CO<sub>2</sub> module will signal no breaths detected. The monitor will alarm if the patient has stopped breathing for longer than the preset apnea time.

The setting range is 10~60 seconds, and the factory setting is 10 seconds.

### ETCO2 UNIT

mmHg, kPa or percent (%) can be chosen, the factory setting is mmHg.

### ETCO2 PERIOD

This setting is used to set the calculation period of the EtCO<sub>2</sub> value. The end-tidal CO<sub>2</sub> value is the highest peak CO<sub>2</sub> value of all ends of expirations (end of breaths) over the selected time period. If less than two breaths exist in the selected time period, the value will be the maximum EtCO<sub>2</sub> value for the last two breathes.

This setting has 1 Breath, 10 Seconds and 20 Seconds for choice. The factory setting is 1 Breath.

### ZERO SETUP

Zero steps refer to "Zeroing the CO<sub>2</sub> Module" section detailed.

Complete the zero procedure by press "**Start Zeroing**" item. During zeroing, a message of "EtCO<sub>2</sub> Zero Started" will be display on the message area.

**[NOTE]:** During the CO<sub>2</sub> module warm-up period after the monitor is powered on, the monitor will perform an automatic zero calibration. The maximum elapsed time for a CO<sub>2</sub> Module zero is 30 seconds. The typical time for a zero is 15 – 20 seconds.

### ZERO GAS TYPE

When performing a zero on room air, this setting should be set to room air (the default). Only change to nitrogen (N<sub>2</sub>) when performing a zero on 100% N<sub>2</sub> gas. This is provided for use in a laboratory environment.

### ADVANCED SETUP

Pick "**ADVANCED SETUP**" item to call up the related menu:



**Figure 16: Tree Diagram for EtCO<sub>2</sub> Advanced Setup**

### SET GAS COMPENSATIONS

The measurement of CO<sub>2</sub> is affected by temperature, pressure, and gas compensations. The barometric pressure as well as the presence of O<sub>2</sub>, N<sub>2</sub>O, helium, and anesthetic agents in the gas mixture needs to be compensated for by the CO<sub>2</sub> module in order to achieve its stated accuracy. The instrument settings for these parameters should be set

when initially connecting to the CO<sub>2</sub> module and whenever there is a change in the conditions at the patient airway.

In the CO<sub>2</sub> module, the temperature of the gas in the airway also effects the CO<sub>2</sub> measurement. It is necessary to adjust the instrument setting for the gas temperature to achieve the maximum accuracy for the CO<sub>2</sub> module.

### **OXYGEN COMPENSATION**

The setting range is 0~100 %. The factory setting is 16 %.

### **BALANCE GAS**

There are Room Air, N<sub>2</sub>O and Helium items to choose. The factory setting is Room Air.

### **ANESTHETIC AGENT**

Use this setting to correct for the compensation of the gas mixture administered to the patient. Anesthetic agent is ignored when the balance gas is set to helium.

The setting range is 0.0~20.0 %. The factory setting is 0.0 %.

**[NOTE]:** At 700 mmHg of pressure, the correct CO<sub>2</sub> value is 35.0 mmHg.

### **BAROMETRIC PRESSURE**

This setting is used to set current Barometric Pressure.

The setting range is 400~850 mmHg. The factory setting is 760 mmHg.

### **GAS TEMPERATURE**

This setting is used to set temperature of the gas mixture. This setting is useful when bench testing using static gasses where the temperature is often room temperature or below.

The setting range is 0~50°C. The factory setting is 35°C.

### **CALIBRATION**

No routine user calibration required, If you find out the CO<sub>2</sub> reading is obviously not correct, for example: the CO<sub>2</sub> reading is with a deviation over 8% (available for 38mmHg or 5% volume ratio of calibration gas) you should send back the monitor to the manufacturer and do a CO<sub>2</sub> concentration calibration.

Safety lock-outs:

- ◆ System does not allow sample cell zero for 20 seconds after the last breath is detected.
- ◆ System does not allow sample cell zero if temperature is not stable.
- ◆ An adapter zero cannot be performed if a sample cell is not connected to the module.

## STATUS/ERROR MESSAGES

Messages	Descriptions
Sensor Off	The CO <sub>2</sub> sensor is not connected
Sensor Warm Up	One of the following conditions exist: Sensor under temperature Temperature not stable Source Current unstable
Sensor Over Temp	Make sure sensor is not exposed to extreme heat (heat lamp, etc.). If error persists, return sensor to factory for servicing.
Sensor error	Check that the sensor is properly plugged in. Reinsert or reset the sensor if necessary. If error persists, return sensor to factory for servicing.
Sensor Zeroing. . .	A zero is currently in progress.
Zero Required	To clear, check airway adapter and clean if necessary. If this does not correct the error, perform an adapter zero. If you must adapter zero more than once, a possible hardware error may exist.
Check Sampling Line	To clear, clean if sampling line mucus or moisture is seen. If the sampling line is clean, perform a zero.
CO <sub>2</sub> Out of Range	The value being calculated is greater than the upper CO <sub>2</sub> limit (150 mmHg, 20.0 kPa, or 19.7 %). The maximum value output is the upper CO <sub>2</sub> .
Check Airway Adapter	To clear, clean airway adapter if mucus or moisture is seen. If the adapter is clean, perform a zero.
Pump Life Exceed	The manufacturer stated pump life has been exceeded. Service may be required if Pneumatic System Error is present and can no longer be cleared.
Sensor Setup. . .	The CO <sub>2</sub> sensor is setting process.
EtCO <sub>2</sub> Zero Error: Sensor Not Ready.	The CO <sub>2</sub> sensor is not ready for a EtCO <sub>2</sub> Zero
EtCO <sub>2</sub> Zero Error: Breath Detected.	Breaths have been detected by the CO <sub>2</sub> module within the last 20 seconds while a CO <sub>2</sub> module zero was attempted.

## MAINTENANCE AND CLEANING

### SCHEDULE

The CO<sub>2</sub> Module flow rate accuracy should be verified by direct measurement using a calibrated flow meter every 12 months, Or when the flow rate is <50ml/min / >150ml/min, You can connect a pipe from the gas outlet to a flow meter and read out the flow rate directly to verify the accuracy.

### CLEANING

Cleaning the CO<sub>2</sub> Module case, Cable and connector:

1. Use a cloth dampened with isopropyl alcohol 70%, a 10% aqueous solution of sodium hypochlorite (bleach), a 2% gluteraldehyde solution, ammonia, mild soap or disinfectant spray cleaner such as Steris Coverage® Spray HB.
2. Wipe down with a clean water-dampened cloth to rinse and dry before use. Make certain that the sensor windows are clean and dry before reuse.

<b>[NOTE]:</b> DO NOT immerse or sterilize the CO <sub>2</sub> Module.
--

Cleaning the Sidestream On-Airway Adapters and Sidestream Sampling Kits:

Sidestream on-airway adapters and sidestream sampling kits are single patient use. Treat in accordance with hospital protocols for handling single patient use devices.

## RECALL DATA

- PATIENT BASIC INFORMATION SETUP
- CLOCK SETUP
- HOW TO RECALL

### PATIENT BASIC INFORMATION SETUP

The user can set by touching the patient ID area at the top left corner to open the patient setup menu. You can have settings as below. CLEO Patient Monitor can save five groups patient information for recall in total.



**Figure 17: Tree Diagram for Patient Setup**

#### ID

Set the ID number of the patient. The ID number for each patient is different and unique. The user can input 12 characters at most.

**[NOTE]:** If you set the same ID with previous patient, the measurement data record will be saved following after the previous data with same ID.

#### SEX

Set the patient gender, the default setting is **MALE**.

#### BLOOD

Set the blood type of patient. It can be: **N/A** (unknown type), **A**, **B**, **AB**, **O**, **RH+** and **RH-**, the default setting is **N/A**.

#### AGE

Set the age of patient. The range is 0 ~120, the default setting is **25**.

**[NOTE]:** The Patient Monitor displays physiological data and stores them in the trends as soon as a patient is connected. This allows you to monitor a patient that is not saved information yet. However, it is recommended that you fully admit a patient so that you can clearly identify your patient, on recordings, reports and networking devices.

**[NOTE]:** Once the user chooses the method of **YES** to exit from the Patient Information Setup, all information of patient will be refreshed and the trend data will be renovated.

### CLOCK SETUP

In order to review data easily and intuitively, you should have set a right time. Touch the time area at the top right corner to open the time setup menu. Also, you can set the clock in the System Setup Menu. You can have settings as below:

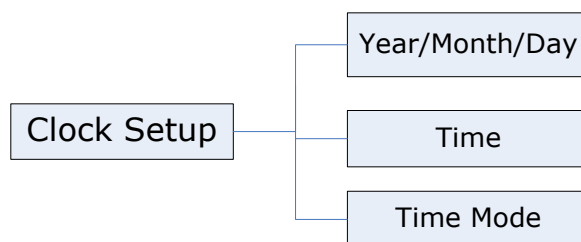

**Figure 18: Tree Diagram for Clock Setup**

The value of year, month, day, hour and minute can be set. System will amend the internal clock according to the new settings.

#### **TIME MODE**

There are two items for choice. 12H and 24H.

Once the system time realigned, the trend data will renew correspondingly.

On entering the master screen, please checks whether the monitor time and the current time are consistent, if not, please correct them.

#### **HOW TO RECALL**

##### **TIME INTERVAL**

Set the time interval of the history data displaying in the trend. You can choose 30 s, 1min, 2 mins, 5 mins, 10 mins, 15 mins and 30 mins.

In Recall menu, choose a user firstly and then choose which parameter is to review. The parameter value in tabular format could be review if the relevant module is ON.

10 groups of measurement value are listed every page and 300 groups in total. Once the recall memory has stored 300 groups of data, the oldest recall data will be overwritten by new data.

These data will be listed follow the order from new to former and the time is displaying at the scale-of-24 hours. The parameter name is display on the top of chart and the invalid data will display '--'.

**SPO2 REVIEW**

The SpO<sub>2</sub> History Data review is as below:

Index	Time	SpO2	PR
1	12/31 20:32:56	98	60
2	12/31 20:32:50	98	60
3	12/31 20:32:44	98	60
4	12/31 20:32:38	98	60
5	12/31 20:32:32	98	60
6	12/31 20:32:26	98	60
7	12/31 20:32:20	98	60
8	12/31 20:32:14	98	60
9	12/31 20:32:08	98	60
10	12/31 20:32:02	98	60

Page Up      Page Down

Exit

**Figure 19: Tabular Trend for SpO<sub>2</sub>**

**ETCO2 REVIEW**

The EtCO<sub>2</sub> History Data review is as below:

Index	Time	EtCO2	awRR
1	12/31 20:29:25	38	20
2	12/31 20:29:19	38	20
3	12/31 20:29:13	38	20
4	12/31 20:29:07	38	20
5	12/31 20:29:01	38	20
6	12/31 20:28:55	38	20
7	12/31 20:28:49	38	20
8	12/31 20:28:43	38	20
9	12/31 20:28:37	38	20
10	12/31 20:28:31	38	20

Page Up      Page Down

Exit

**Figure 20: Tabular Trend for EtCO<sub>2</sub>**

**NIBP REVIEW**

The NIBP History Data review is as below:

Index	Time	SYS	DIA
1	12/31 20:29:25	120	80
2	12/31 20:29:19	120	80
3	12/31 20:29:13	120	80
4	12/31 20:29:07	120	80
5	12/31 20:29:01	120	80
6	12/31 20:28:55	120	80
7	12/31 20:28:49	120	80
8	12/31 20:28:43	120	80
9	12/31 20:28:37	120	80
10	12/31 20:28:31	120	80

**Figure 21: Tabular Trend for NIBP**

**QTEMP REVIEW**

The QTemp History Data review is as below:

Index	Time	Temp
1	12/31 20:29:25	36.5
2	12/31 20:29:19	36.5
3	12/31 20:29:13	36.5
4	12/31 20:29:07	36.5
5	12/31 20:29:01	36.5
6	12/31 20:28:55	36.5
7	12/31 20:28:49	36.5
8	12/31 20:28:43	36.5
9	12/31 20:28:37	36.5
10	12/31 20:28:31	36.5

**Figure 22: Tabular Trend for QTemp**

## BATTERY OPERATION

CLEO Patient Monitor is designed to operate on one rechargeable Lithium ion battery whenever AC power supply is interrupted. A symbol is displayed in the upper right quarter of the screen to indicate the status of recharging, in which the color part represents the electric energy of the battery.

A new, fully charged battery will provide about 3 hour of monitoring time under the following conditions: no audible alarms, no analog or serial output devices attached, and no backlight.

The charge and discharge cycles life of the battery is about 300 times. Life expectancy of a battery depends on how frequent and how long it is used. For a properly maintained and stored lithium-ion battery, its life expectancy is about 3 years. For more aggressive use models, life expectancy can be less. We recommend replacing lithium-ion batteries every 3 years.

When operating on battery, the monitor will shut off automatically when the electric energy is low. When the electric energy is lower than 25% of total power capacity, the battery signal will change red. Connect the monitor to AC power at this moment can recharge the battery while operating. If keep operating on the battery, the monitor will shut off automatically upon exhaustion of the battery.

**[NOTE]:** Whenever the monitor is connected to AC power, the battery is being charged. Therefore, it is recommended that the monitor remain connected to AC power when not in use. This will make available a fully charged battery for use at any time.

**[NOTE]:** As the battery is used and recharged over a period of time, the amount of time between the onset of the low battery alarm and the instrument shut-off may become shorter.  
If the backlight is turned off during a low battery condition, it cannot be turned back on. It is recommended that the internal battery is replaced by qualified service personnel every 24 months.

**[CAUTION]:** If the CLEO is to be stored for a period of 2 months or longer, notify service personnel to remove the battery from the monitor prior to storage. Recharge the battery when it has not been charged for 2 or more months.

## BATTERY RECYCLE

When a battery has visual signs of damage, or no longer holds a charge, it should be replaced. Remove the old battery from the Patient Monitor and recycle it properly. To dispose of a battery, follow local laws for proper disposal.

**[WARNING]:** DO NOT disassemble batteries, or put them into fire, or cause them to short circuit. They may ignite, explode, or leak, causing personal injury.

## **DISPOSAL OF DEVICE COMPONENTS**

Follow local governing ordinances and recycling instructions regarding disposal or recycling of device components, including batteries.

## CLEANING

To clean the CLEO Patient Monitor, dampen a cloth with a commercial, nonabrasive cleaner and wipe the exterior surfaces lightly. Do not allow any liquids to come in contact with the power connector or switches. Do not allow any liquids to penetrate connectors or openings in the instrument. For cables, sensors, and cuffs, follow the cleaning instructions in the directions for use that accompany these accessories.

## PERIODIC SAFETY CHECKS

It is recommended that the following checks be performed every 24 months.

- Inspect the equipment for mechanical and functional damage.
- Inspect the safety relevant labels for legibility.

**[WARNING]:** Do not spray, pour, or spill liquid on CLEO, its accessories, connectors, switches, or openings in the chassis. Do not immerse the CLEO or its accessories in liquid or clean with caustic or abrasive cleaners.

The Life expectancy of the CLEO Patient Monitor depends on how frequent and how long it is used. For a properly maintained, its life expectancy is 5 years. For more aggressive use models, life expectancy can be less. We recommend replacing the monitor every 5 years.

## SPECIFICATIONS

<b>SAFETY</b>	
Meet the requirement of EN60601 series, CE marking according to MDD93/42/EEC	
Equipment not suitable for use in the presence of a flammable anesthetic mixture with air or with oxygen or nitrous oxide	
Type of Protection:	Class I (on AC power) Internally Powered (on battery power)
Degree of Protection:	Type BF - Applied part
Sterilization or Disinfection methods:	70% isopropyl alcohol solution or a non-staining disinfectant.
Operation Mode:	Continuous Operation
Protection Against Ingress of Liquid's:	IPX0
<b>APPLICATION</b>	
Adult Patients	
Physical Dimensions & Weight	
Base Unit:	120×125×195 mm
Weight:	900 g
<b>PERFORMANCE SPECIFICATIONS</b>	
Display:	5.0 Inch(Diagonal) Color TFT
Resolution:	480×RGB×270
Trace:	2 Waveforms
Waveforms	PLETH, EtCO <sub>2</sub>
Indicator:	Alarm Indicator Power Indicator
Trend time:	72 hours
<b>SPO2</b>	
Standard:	ISO 9919
ASpO <sub>2</sub> :	Anti-motion SpO <sub>2</sub>
Measurement Technology:	Light Absorption Method
SpO <sub>2</sub> Probe:	Red Light LED Wavelength: 660±5 nm Infrared Light LED Wavelength: 940±10 nm
Option Type:	Infinium, Masimo (See each module's relative technical specifications)
Refresh Rate:	1 s
SpO <sub>2</sub> Alarm Limit:	Upper Limit : 50~99 % Lower Limit : 50~99 %
PR Alarm Limit:	Upper Limit : 70~239 bpm Lower Limit : 20~150 bpm
<b>Infinium SPO2</b>	
SpO <sub>2</sub> Measurement Range:	0~100 %
SpO <sub>2</sub> Resolution:	1%
SpO <sub>2</sub> Accuracy:	70~100 %: ±2 % (non-motion) 70~100 %: ±3 % (motion) 0~69 % : Undefined
PR Measurement Range:	30~250 bpm
PR Resolution:	1 bpm
PR Accuracy:	±2 bpm (non-motion) ±3 bpm (motion)
<b>MASIMO SPO2<sup>7,9</sup></b>	
Measurement Range:	SpO <sub>2</sub> : 1~100 %
	PR: 20~300 bpm
	Perfusion: 0.02~20 %

SpO <sub>2</sub> Accuracy: (non-motion) <sup>1,8</sup>	Adult	70~100 %: ±2 % 0~69% : unspecified
SpO <sub>2</sub> Accuracy: (motion) <sup>2,3</sup>	Adult	70~100 %: ±3 % 0~69% : unspecified
PR Accuracy: (non-motion) <sup>1,5,8</sup>	Adult	25~240 bpm: ±3 bpm
PR Accuracy: (motion) <sup>2,3,5</sup>	Adult	25~240 bpm: ±5 bpm
SpO <sub>2</sub> Resolution:	1 %	
PR Resolution:	1 bpm	
Low Perfusion Performance <sup>4</sup> :	>0.02 % Pulse Amplitude and % Transmission >5 %	SpO <sub>2</sub> : ±2 % PR: ±3 bpm
Modes:	Averaging mode: 2,4,8,10,12,14 and 16 s	
	Sensitivity: Normal, APOD and Maximum	
<p><sup>1</sup>. The CLEO with Masimo specified sensor has been validated for no motion accuracy in human blood studies on healthy adult volunteers in induced hypoxia studies in the range of 70-100 % SpO<sub>2</sub> against a laboratory co-oximeter and ECG monitor. This variation equals plus or minus one standard deviation. Plus or minus one standard deviation encompasses 68 % of the population.</p>		
<p><sup>2</sup>. The CLEO with Masimo specified sensor has been validated for motion accuracy in human blood studies on healthy adult volunteers in induced hypoxia studies while performing rubbing and tapping motions at 2 to 4 Hz at an amplitude of 1 to 2 cm and a non-repetitive motion between 1 to 5 Hz at an amplitude of 2 to 3 cm in induced hypoxia studies in the range of 70 – 100 % SpO<sub>2</sub> against a laboratory co-oximeter and ECG monitor. This variation equals plus or minus one standard deviation. Plus or minus one standard deviation encompasses 68 % of the population.</p>		
<p><sup>3</sup>. The CLEO with Masimo specified sensor has been validated for motion and no motion accuracy in human blood studies on healthy adult volunteers in induced hypoxia studies while performing rubbing and tapping motions at 2 to 4 Hz at an amplitude of 1 to 2 cm and a non-repetitive motion between 1 to 5 Hz at an amplitude of 2 to 3 cm in induced hypoxia studies in the range of 70 – 100 % SpO<sub>2</sub> against a laboratory co-oximeter and ECG monitor. 1% has been added to the results to account for the effects of fetal hemoglobin. This variation equals plus or minus one standard deviation. Plus or minus one standard deviation encompasses 68% of the population.</p>		
<p><sup>4</sup>. The CLEO with Masimo specified sensor has been validated for low perfusion accuracy in bench top testing against a Biotek Index 2 simulator and Masimo's simulator with signal strengths of greater than 0.02 % and a % transmission of greater than 5 % for saturations ranging from 70 to 100 %. This variation equals plus or minus one standard deviation. Plus or minus one standard deviation encompasses 68 % of the population.</p>		
<p><sup>5</sup>. The CLEO with Masimo specified sensor has been validated for neonatal motion accuracy in human blood studies on healthy adult volunteers in induced hypoxia studies while performing rubbing and tapping motions at 2 to 4 Hz at an amplitude of 1 to 2 cm and a non-repetitive motion between 1 to 5 Hz at an amplitude of 2 to 3 cm in induced hypoxia studies in the range of 70 – 100 % SpO<sub>2</sub> against a laboratory co-oximeter and ECG monitor. 1% has been added to the results to account for the effects of fetal hemoglobin. This variation equals plus or minus one standard deviation, which encompasses 68% of the population.</p>		
<p><sup>6</sup>. The CLEO with Masimo specified sensor has been validated for pulse rate accuracy for the range of 25-240 bpm in bench top testing against a Biotek Index 2 simulator. This variation equals plus or minus one standard deviation ,which encompasses 68 % of the population.</p>		
<p><sup>7</sup>. Unless otherwise indicated, reposition Masimo specified reusable sensors at least every 4 hours and adhesive sensors at least every 8 hours.</p>		

<sup>8</sup> The Masimo LNOP Blue <sup>®</sup> sensor is the predicate.	
<b>NIBP</b>	
Standard:	EN 60601-2-30/IEC 60601-2-30, EN 1060-1, EN 1060-3, EN 1060-4, SP10
Measurement Technology:	Automatic Oscillating Measurement
Cuff Inflating:	<30 s (0~300 mmHg, Standard Adult Cuff)
Max Measuring Time:	Adult 180 s
Mode:	Manual, Auto, STAT
Measuring Interval in AUTO Mode:	1 min~4 hrs
Measurement Range:	Adult Mode SYS 40~250 (mmHg) DIA 15~200 (mmHg)
Resolution:	1mmHg
Pressure Accuracy:	Maximum Mean Error: $\pm 5$ mmHg Maximum Standard Deviation: 8 mmHg
Overpressure Protection:	Adult Mode: 297 (mmHg)
Alarm Limit:	SYS (Upper/Lower): 30~240 mmHg DIA (Upper/Lower): 15~180 mmHg
Pulse Rate Accuracy:	$\leq 2$ bpm (PR $\leq 100$ bpm) $\leq 2\%$ (PR $> 100$ bpm)
<b>QUICK TEMPERATURE</b>	
Standards:	Meets performance standards of EN 12470-3:2000, ASTM E1112:2006
Temperature Measurement Range:	30°C~43°C (86°F~109°F)
Typical Measurement Times (after insertion into measurement site):	Oral (Quick Mode): 3 ~ 5 s (non-fever temps), 8~10 s (fever temps) Oral (Standard Mode): 6~10 s Axillary Mode: 8~12 s Rectal Mode: 10~14 s Direct Mode (All Sites): 60~120 s
Accuracy:	A Standard Prediction Mode reading and a Direct Mode reading will differ by less than $\pm 0.2^{\circ}\text{C}$ ( $\pm 0.4^{\circ}\text{F}$ ) on 98% of tested patients
<b>CO2</b>	
Mode of Sampling:	Sidestream
Measurement Technology:	Infrared Absorption
Standards:	ISO 21647
Principle of Operation:	Non-dispersive Infrared (NDIR) single beam optics, dual wavelength, no moving parts.
Initialization Time:	Capnogram displayed in less than 20 s, at an ambient temperature of 25°C, full specifications within 2 minutes.
CO <sub>2</sub> Measurement Range:	0 ~ 150 mmHg (0 ~ 19.7 %, 0 ~ 20 kPa) (Barometric Pressure supplied by Monitor)
CO <sub>2</sub> Calculation Method:	BTPS (Body Temperature Pressure Saturated)
Response Time:	<3 s ( includes transport time and rise time)
CO <sub>2</sub> Resolution:	0~69 mmHg: 0.1 mmHg 70~150 mmHg: 0.25 mmHg

CO <sub>2</sub> Accuracy:	0~40 mmHg: ± 2 mmHg 41~70 mmHg : ± 5 % of reading 71~100 mmHg: ± 8 % of reading 101~150 mmHg: ±10 % of reading Above 80 breath per minute ± 12 % of reading <b>[NOTE]:Gas temperature at 25°C.</b>	
CO <sub>2</sub> Stability:	Short Term Drift: Drift over four hours shall not exceed a maximum 0.8 mmHg. Long Term Drift: Accuracy specifications will be maintained over a 120-hour period.	
CO <sub>2</sub> Noise:	RMS noise of the sensor shall be less than or equal to 0.25 mmHg at 5 % CO <sub>2</sub>	
Sampling Rate:	100 Hz	
ETCO <sub>2</sub> Calculation:	Method: Peak of the expired CO <sub>2</sub> waveform Selections: 1 breath, 10 s, 20 s	
Inspired CO <sub>2</sub> Measurement:	Range: 3~50 mmHg Method: Lowest reading of the CO <sub>2</sub> waveform in the previous 20 s Selection: 20 s (not user-selectable)	
awRR Measurement Range:	2~150 rpm	
awRR Accuracy:	±1 breath	
EtCO <sub>2</sub> Alarm Limit:	Upper Limit : 20~100 mmHg Lower Limit : 10~95 mmHg	
awRR Alarm Limit:	Upper Limit : 10~150 rpm Lower Limit : 5~100 rpm	
Apnea Time:	10~60 s	
Anesthetic Agent Effects (MAC levels)	Anesthetic Agent Sensitivity <sup>1)</sup> (uncompensated)	Accuracy specification will be maintained for halogenated anesthetic agents present at accepted MAC (Minimum Alveolar Concentration) clinical levels.
<sup>1)</sup> MAC Level %(v/v): Halothane 0.74; Enflurane 1.68; Isoflurane 2.00; Desflurane 6.30.		
<b>NETWORKING</b>		
Wired Networking:	Industry Standard: IEEE 802.3 wired network RJ45 interface and USB port	
<b>POWER</b>		
Source:	External AC Power and Internal Battery	
AC Power:	100/240 VAC, 50/60 Hz, 30VA, F2AL 250V	
Battery:	Rechargeable Lithium ion battery, 7.2 V/2000 mAh	
	Operating time under normal conditions:	3 hrs
	Operating time after first sounding of low-battery alarm:	10 mins
	Charge Time:	8 hrs
	Number of Batteries:	1
<b>ENVIRONMENTAL SPECIFICATIONS</b>		
Operating Conditions		
Temperature:	0~40 °C	
Humidity Range (Noncondensing):	15~95%	
Barometric (mmHg)	428.6~808.3 mmHg (57.0~107.5Kpa)	

	428~790 mmHg (with Sidestream CO <sub>2</sub> module) 430~795 mmHg (with Microstream CO <sub>2</sub> module) 400~850 mmHg (with Mainstream CO <sub>2</sub> module)
<b>Storage Conditions</b>	
Temperature:	-20~60°C
Humidity Range (Noncondensing):	10~95%
Barometric (mmHg):	122.6~808.3 mmHg (16.3~107.5Kpa) 428~790 mmHg (with Sidestream CO <sub>2</sub> module) 430~795 mmHg (with Microstream CO <sub>2</sub> module) 400~850 mmHg (with Mainstream CO <sub>2</sub> module)

## EMC

The product is in radio-interference protection class A in accordance with EN55011. The product complies with the requirements of standard EN60601-1-2:2007 "Electromagnetic Compatibility - Medical Electrical Equipment".

### ELECTROMAGNETIC IMMUNITY

This section constitutes the guidance and CLEO Patient Monitor's declaration regarding electromagnetic immunity. The CLEO Patient Monitor is intended for use in the electromagnetic environment specified below. The customer or the user of the CLEO Patient Monitor should ensure that it is used in such an environment.

Immunity test	IEC 60601 test level	Compliance level	Electromagnetic environment – guidance
Electrostatic discharge (ESD) IEC 61000-4-2	<input type="checkbox"/> 6 kV contact <input type="checkbox"/> 8 kV air	<input type="checkbox"/> 6 kV contact <input type="checkbox"/> 8 kV air	Floors should be wood, concrete or ceramic tile. If floors are covered with synthetic material, the relative humidity should be at least 30%.
Electrical fast transient/burst IEC 61000-4-4	2 kV for power supply lines 1 kV for input / output lines	2 kV for power supply lines 1 kV for input / output lines	Mains power quality should be that of a typical commercial or hospital environment.
Surge IEC 61000-4-5	<input type="checkbox"/> 1 kV differential Mode <input type="checkbox"/> 2 kV differential Mode	<input type="checkbox"/> 1 kV differential Mode <input type="checkbox"/> 2 kV differential Mode	Mains power quality should be that of a typical commercial or hospital environment.
Voltage dips, short interruptions and voltage variations on power supply input lines IEC 61000-4-11	<5 % UT <sup>1</sup> (>95 % dip in UT) for 0.5 cycle 40 % UT (60 % dip in UT) for 5 cycles 70 % UT (30 % dip in UT) for 25 cycles <5 % UT (>95 % dip in UT) for 5 sec	<5 % UT <sup>2</sup> (>95 % dip in UT) for 0.5 cycle 40 % UT (60 % dip in UT) for 5 cycles 70 % UT (30 % dip in UT) for 25 cycles <5 % UT (>95 % dip in UT) for 5 sec	Mains power quality should be that of a typical commercial or hospital environment. If the user of the CLEO Patient Monitor requires continued operation during power mains interruptions, then the CLEO Patient Monitor should be powered from an uninterruptible power supply or a battery.
Power frequency (50/60 Hz) magnetic field IEC 61000-4-8	3 A/m	3 A/m	Power frequency magnetic fields should be at levels typical in a commercial or hospital environment.

Note: *UT* is the a. c. mains voltage prior to application of the test level.

Immunity test	IEC 60601 test level	Compliance level	Electromagnetic environment – guidance
<p>Conducted RF IEC 61000-4-6</p> <p>Radiated RF IEC 61000-4-3</p> <p>Only ISA CO<sub>2</sub> is tested at 20 V/m</p>	<p>3 Vrms 150 kHz to 80 MHz</p> <p>3 V/m 80%AM@2Hz 80 MHz to 2.5 GHz</p> <p>20 V/m 80%AM@1kHz z 80 MHz to 2.5 GHz</p>	<p>3 Vrms</p> <p>3 V/m</p> <p>20 V/m</p>	<p>Portable and mobile RF communications equipment should be used no closer to any part of the CLEO Patient Monitor, including cables, than the recommended separation distance, which can be calculated using the formula applicable to the frequency of the transmitter.</p> <p>The formulas for calculating the recommended separation distance are as follows:</p> $d = 1.2\sqrt{P}$ <p>80 MHz to 800 MHz</p> $d = 2.3\sqrt{P}$ <p>800 MHz to 2.5 GHz</p> <p>Where P is the maximum output power rating of the transmitter in watts (W) according to the transmitter manufacturer and d is the recommended separation distance in meters (m).</p> <p>Field strengths from fixed RF transmitters, as determined by an electromagnetic site survey <sup>a)</sup>, should be less than the compliance level in each frequency range <sup>b)</sup>.</p> <p>Interference may occur in the vicinity of equipment marked with the following symbol:</p> 
<p><b>[NOTE 1]: At 80 MHz and 800 MHz, the higher frequency range applies.</b></p> <p><b>[NOTE 2]: These guidelines may not apply in all situations. Electromagnetic propagation is affected by absorption and reflection from structures, objects and people.</b></p> <p>a). Field strengths from fixed transmitters, such as base stations for radio (cellular/cordless) telephones and land mobile radios, amateur radio, AM and FM radio and TV broadcasters cannot be accurately predicted theoretically. To assess the electromagnetic environment due to fixed RF transmitters, an electromagnetic site survey should be conducted. If the measured field strength in the location in which the CLEO Patient Monitor is used exceeds the applicable RF compliance level, verify that the CLEO Patient Monitor works normally. If you observed abnormal performance, you may need to reorient or relocating the CLEO Patient Monitor.</p> <p>b). Over the frequency range of 150 kHz to 80 MHz, field strengths should be less than 3V/m.</p>			

Immunity test	IEC 60601 test level	Compliance level	Electromagnetic environment – guidance	
<b>Recommended separation distances between portable and mobile RF communications equipment and the CLEO Patient Monitor</b>				
<p>The CLEO Patient Monitor is intended for use in an electromagnetic environment in which radiated RF disturbances are controlled.</p> <p>The customer or the user of the CLEO Patient Monitor can help prevent electromagnetic interference by maintaining a minimum distance between portable and mobile RF communications equipment (transmitters) and the CLEO Patient Monitor as recommended below, according to the maximum output power of the communications equipment</p>				
<b>Rated maximum output power of transmitter [W]</b>	<b>Separation distance according to frequency of transmitter [m]</b>			
	<b>150 kHz to 80 MHz</b> $d = 1.2\sqrt{P}$	<b>80 MHz to 800 MHz</b> $d = 1.2\sqrt{P}$	<b>800 MHz to 2.5 GHz</b> $d = 2.3\sqrt{P}$	
<b>0.01</b>	<b>0.12</b>	<b>0.12</b>	<b>0.23</b>	
<b>0.1</b>	<b>0.38</b>	<b>0.38</b>	<b>0.73</b>	
<b>1</b>	<b>1.2</b>	<b>1.2</b>	<b>2.3</b>	
<b>10</b>	<b>3.8</b>	<b>3.8</b>	<b>7.3</b>	
<b>100</b>	<b>12</b>	<b>12</b>	<b>23</b>	
<p>For transmitters rated at a maximum output power not listed above, the recommended separation distance <math>d</math> in meters (m) can be estimated using the formula applicable to the frequency of the transmitter, where <math>P</math> is the maximum output power rating of the transmitter in watts (W) according to the transmitter manufacturer.</p>				