



CLEO  
Patient Monitor

**USA USER'S MANUAL**

## Infinium Medical Inc.

Website: [www.infiniummedical.com](http://www.infiniummedical.com)

Address: 12151 62nd St North #5

Largo FL, 33773 USA

Toll Free (US call only): 866-918-8434

International: 1-727-531-8434

Fax: 1-727-531-8436

To obtain information about a warranty, if any, for this product, contact Infinium Medical Inc, Technical Services or your local Infinium Medical, Inc. representative.

***Nellcor is a trademark of NELLCOR OXIMAX***



## CONTENTS

FIGURES .....	5
SAFETY INFORMATION .....	4
INTRODUCTION .....	7
INTENDED USE .....	7
ABOUT THIS MANUAL .....	7
CONTROLS, INDICATORS, AND SYMBOLS.....	8
FRONT AND SIDE PANEL.....	8
REAR PANEL .....	9
SYMBOLS.....	10
DISPLAY SCREEN PARTITION .....	12
SINGLE SPO2 DISPLAY .....	13
SINGLE ETCO2 DISPLAY.....	13
SPO2+ETCO2 DISPLAY .....	14
SPO2+NBP DISPLAY .....	14
SPO2 +NBP+ETCO2 DISPLAY.....	15
SPO2+NBP DISPLAY .....	15
SYSTEM SETUP.....	16
FACTORY SEVICING SETUP.....	16
SOUND VOLUME .....	17
ALARM SWITCH .....	17
MODULE SELECT.....	17
DEFAULT CONFIG.....	17
SAVE CONFIG .....	17
HOW TO MONITOR.....	18
ALARM & SOUND.....	19
ALARM.....	19
ALARM PRIORITY .....	19
High Priority.....	19
Medium Priority .....	19
Low Priority .....	19
VISUAL ALARM INDICATORS.....	19
SOUND .....	20
ALARM SOUND.....	20
PULSE-TONE.....	20
KEY BEEPS.....	20

MUTE .....	20
SPO2 MONITORING.....	21
SPO2 MONITORING PRINCIPLE .....	21
SPO2 SENSOR INSTALLLATION .....	21
SPO2 WAVEFORM SETUP .....	21
CHOOSE MODULE .....	22
SWEEP SPEED.....	22
SWEEP COLOR .....	22
SPO2 PARAMETER SETUP .....	22
ALARM SWITCH .....	22
SPO2 ALARM HIGH .....	22
SPO2 ALARM LOW .....	22
PR ALARM HIGH.....	22
PR ALARM LOW.....	22
MEASUREMENT LIMITATIONS .....	23
SPO2 ERROR MESSAGES .....	23
NO IMPLIED LICENSE.....	24
MEASUREMENTS .....	24
Incorrect measurements may be caused by:.....	24
Loss of pulse signal can occur in any of the following situation: .....	24
SENSORS .....	25
NELLCOR INFORMATION.....	25
TRADEMARK AND LICENSING LABELS.....	25
NO IMPLIED LICENSE.....	25
NIBP MONITORING.....	26
SUMMARY ON NIBP MONITORING.....	26
NIBP CUFF FITTING.....	26
NIBP MONITORING INITIALIZATION.....	27
NIBP PARAMETER SETUP .....	27
DISPLAY COLOR.....	27
ALARM SWITCH .....	27
PRESSURE UNIT.....	28
ADULT TYPE.....	28
INFLATION MODE .....	28
MANUAL MODE: .....	28
AUTOMATIC MODE.....	28
STAT MODE.....	29

TIME INTERVAL.....	29
ALARM LIMIT SETUP .....	29
NIBP LIST OBSERVATION .....	29
MEASUREMENT LIMITATIONS .....	30
PATIENT MOVEMENT .....	30
CARDIAC ARRHYTHMIA'S .....	30
HEART-LUNG MACHINE .....	30
PRESSURE CHANGES.....	30
SEVERE SHOCK .....	30
HEART RATE EXTREMES.....	30
NIBP ERROR MESSAGES .....	31
MAINTAINENCE AND CLEANING.....	31
REUSABLE BLOOD PRESSURE CUFF.....	31
ETCO2 MONITORING .....	32
THEORY OF OPERATION.....	32
WARNINGS, CAUTIONS AND NOTES .....	32
WARNINGS.....	32
CAUTIONS.....	33
NOTES.....	33
ABBREVIATIONS AND TERMINOLOGY.....	33
ZEROING THE CO2 MODULE.....	33
NOTES:.....	34
PATIENT AND TUBING PREPARATION.....	34
MODULE MOUNTING .....	34
CONNECTING THE SAMPLE KIT.....	34
DIRECTIONS .....	34
ETCO2 WAVEFORM SETUP.....	35
WAVEFORM SCALE.....	36
SWEEP SPEED.....	36
SWEEP COLOR .....	36
ETCO2 PARAMETER SETUP.....	36
ALARM SWITCH .....	36
ETCO2 ALARM HIGH .....	37
ETCO2 ALARM LOW .....	37
AWRR ALARM HIGH .....	37
AWRR ALARM LOW.....	37
ASPHYXIA DELAY .....	37
ETCO2 UNIT .....	37

ETCO2 PERIOD .....	37
ZERO SETUP .....	37
ZERO GAS TYPE.....	37
<b>ADVANCED SETUP .....</b>	<b>37</b>
SET GAS COMPENSATIONS .....	38
OXYGEN COMPENSATION .....	38
BALANCE GAS .....	38
ANESTHETIC AGENT (Not Cleared for USA) .....	38
BAROMETRIC PRESSURE .....	38
GAS TEMPERATURE .....	38
CALIBRATION .....	38
STATUS/ERROR MESSAGES.....	39
MAINTENANCE AND CLEANING.....	39
SCHEDULE .....	39
CLEANING .....	39
RECALL DATA.....	40
PATIENT BASIC INFORMATION SETUP.....	40
ID .....	40
SEX.....	40
CLOCK SETUP.....	41
HOW TO RECALL .....	41
SPO2 REVIEW .....	42
ETCO2 REVIEW .....	42
NBP REVIEW.....	43
BATTERY OPERATION.....	44
BATTERY RECYCLE .....	44
DISPOSAL OF DEVICE COMPONENTS .....	45
CLEANING .....	46
PERIODIC SAFETY CHECKS .....	46
SPECIFICATIONS.....	46
EMC.....	49
ELECTROMAGNETIC IMMUNITY .....	49

## FIGURES

Figure 1: Front and Side Panel.....	8
Figure 2: Rear View for Main Unit.....	9
Figure 3: Single SpO <sub>2</sub> Display Screen .....	13
Figure 4: Single EtCO <sub>2</sub> Display Screen .....	13
Figure 5: SpO <sub>2</sub> and EtCO <sub>2</sub> Display Screen .....	14
Figure 6: SpO <sub>2</sub> and NBP Display Screen.....	14
Figure 7: SpO <sub>2</sub> , EtCO <sub>2</sub> and NBP Display Screen .....	15
Figure 8: SpO <sub>2</sub> and NBP Display Screen.....	15
Figure 9: Tree Diagram for System Setup Menu .....	16
Figure 10: Window for Ethernet IP Address Setup .....	16
Figure 11: Tree Diagram for Pleth Menu.....	21
Figure 12: Tree Diagram for SpO <sub>2</sub> Setup Menu.....	22
Figure 13: Tree Diagram for NIBP Setup Menu .....	27
Figure 14: Window for NIBP List Observation .....	30
Figure 15: Tree Diagram for EtCO <sub>2</sub> Waveform Setup Menu .....	36
Figure 16: Tree Diagram for EtCO <sub>2</sub> Parameter Setup Menu .....	36
Figure 17: Tree Diagram for EtCO <sub>2</sub> Advanced Setup .....	38
Figure 18: Tree Diagram for Patient Setup .....	40
Figure 19: Tree Diagram for Clock Setup .....	41
Figure 20: User Choose and Module Choose .....	41
Figure 21: Tabular Trend for SpO <sub>2</sub> .....	42
Figure 22: Tabular Trend for EtCO <sub>2</sub> .....	42
Figure 23: Tabular Trend for NBP .....	43

## SAFETY INFORMATION

This section contains important safety information related to general use of the CLEO Patient Monitor. Other important safety information appears throughout the manual in sections that relate specifically to the precautionary information. Read all text surrounding all precautionary information.

The CLEO can be powered by an internal battery that provides 3 hours of monitoring from fully charged batteries. The batteries are continuously recharged when AC power is connected to the monitor.

A warning message appears on the screen and an audible alarm sounds when the remaining battery power is only enough for 15 minutes of operation. The user should connect the monitor to an external power source to avoid loss of patient monitoring action. External power sources may be connected, disconnected, and reconnected without interrupting the monitoring action.

**CAUTION:** Federal law (USA) restricts this device to sale by or on the order of a physician only.

**[NOTE]:** Before use, please read this manual carefully.

**[WARNING]:** CLEO Patient Monitor should not be used as an apnea monitor.

**[WARNING]:** CLEO Patient Monitor should only be used on Adult Patients.

**[WARNING]:** MRI Unsafe – DO NOT use in MRI environments.

**[WARNING]:** CLEO Patient Monitor is defibrillator proof. It may remain attached to the patient during defibrillation or while an electrosurgical unit is in use, but the readings may be inaccurate during use and shortly thereafter.

**WARNING:** CLEO patient monitor is a prescription device and is to be operated by qualified personnel only.

**[WARNING]:** Explosion hazard. DO NOT use the CLEO in the presence of flammable anesthetics or other flammable substance in combination with air, oxygen-enriched environments, or nitrous oxide.

**[WARNING]:** DO NOT lift the monitor by the sensor cable, blood pressure hose, or power cord because the cable, lead, or cord could disconnect from the monitor, causing the monitor to drop on the patient.

**[WARNING]:** CLEO Patient Monitor may not operate effectively on patients who are experiencing convulsions or tremors.

**[WARNING]:** Disconnect the CLEO and sensors during magnetic resonance imaging (MRI) scanning. Use during MRI could cause burns or adversely affect the MRI image or the monitor's accuracy. Also, to avoid burns, remove the sensors from the patient before conducting MRI.

**[WARNING]:** To ensure that the leakage current protection remains within the specifications, use only the patient cables supplied with or specifically intended for use with the CLEO Monitors. Carefully route patient cables to reduce the possibility of patient entanglement or strangulation.

**[WARNING]:** The user must check the equipment prior to use and ensure its safe and proper use.

**[WARNING]:** To ensure patient safety, DO NOT place the monitor in any position that might cause it to fall on the patient.

**[WARNING]:** Enclosure leakage current is less than 100 microamperes ( $\mu\text{A}$ ); however, always consider additional leakage current that can be caused by other equipment used on the patient at the same time as these monitors.

**[WARNING]:** DO NOT autoclave, ethylene oxide sterilize, or immerse these monitors in liquid. Use the cleaning solution sparingly. Excessive solution can flow into the monitor and cause damage to internal components. Do not use petroleum-based or acetone solutions, or other harsh solvents, to clean the monitor. These substances attack the monitor's materials and device failure can result. Unplug the monitors before cleaning or disinfecting.

**[WARNING]:** DO NOT touch, press, or rub the display panels with abrasive cleaning compounds, instruments, brushes, rough surface materials, or bring them into contact with anything that could scratch the panel.

**[WARNING]:** DO NOT use the CLEO to monitor patients who are linked to heart/lung machines.

**[WARNING]:** To prevent electrical hazards to all personnel, CLEO Patient Monitor must be properly grounded. The chassis grounding assembly, Universal Switching Power Supply, and the power cord supplied with the equipment provides for this protection. DO NOT attempt to defeat this protection by modifying the cords or using ungrounded adapters. DO NOT remove the monitor cover except to replace the battery.

**[WARNING]:** If there is any doubt about the integrity of the protective earth conductor arrangement, operate the monitor on internal battery power until the AC power supply protective conductor is fully functional.

**[WARNING]:** The CLEO monitor is not intended to be used with Xenon or Helium gasses

**Caution:** When connecting the CLEO to any instrument, verify proper operation before clinical use. Both the CLEO and the instrument connected to it must be connected to a grounded outlet. Accessory equipments connected to this patient monitor must be certified according to the respective IEC standards (e.g. IEC 60950 for information technology equipment and IEC 60601-1 for medical electrical equipment). Furthermore all configurations shall comply with the valid version of the system standard IEC 60601-1-1.

Any person who connects additional equipment to the signal input or signal output is responsible to ensure the system complies with the requirements of the valid version of the system standard IEC 60601-1-1. If you have any questions, please be free to contact our company or customer service.

To ensure accurate readings, consider the environmental conditions that are present and the condition of the patient. See the appropriate sections of the manual for specific safety information related to these conditions.

## INTRODUCTION

- INTENDED USE
- ABOUT THIS MANUAL

### INTENDED USE

The purpose and function of the CLEO patient monitor is to monitor basic physiological parameters including

- NIBP(systolic and diastolic)
- SpO<sub>2</sub>
- ETCO<sub>2</sub>

The target population is for adults only

It may be used as bedside or portable monitor and be used in all hospitals and hospital-type facilities such as clinics and emergency room facilities. It is to be used under the direct supervision of a licensed healthcare practitioner.

**[WARNING]:** CLEO Patient Monitor is intended only as an adjunct in patient assessment. It must be used in conjunction with clinical signs and symptoms.

### ABOUT THIS MANUAL

This manual explains how to set up and use the CLEO Patient Monitor. Important safety information relating to general use of the CLEO appears before this introduction. Other important safety information is located throughout the text where applicable. **Read the entire manual including the Safety Information section before you operate the monitor.**

## CONTROLS, INDICATORS, AND SYMBOLS

- FRONT AND SIDE PANEL
- REAR PANEL
- SYMBOLS

### FRONT AND SIDE PANEL



Figure 1: Front and Side Panel

No.	Function	Icon
1.	Power Switch	
2.	AC ON This LED indicates that the monitor is powered by AC.	
3.	DC ON This LED indicates that the monitor is powered by battery.	
4.	NIBP Port for the connection with the blood pressure cuff hose	
5.	Oxygen Saturation Sensor Port for Infinium SpO <sub>2</sub>	
6.	Sensor Port for External EtCO <sub>2</sub>	
7.	Air Pipe for Inner EtCO <sub>2</sub>	
8.	Oxygen Saturation Sensor Port for Nellcor	
9.	USB Port Transfer data to PC; Upgrade program	
10.	Ethernet Port Upgrade program	
11.	Alarm Indicator In normal mode, no indicator lights. In alarm mode, the alarm indicator flashes.	

## REAR PANEL

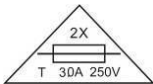













**Figure 2: Rear View for Main Unit**



No.	Function	Icon
1	Battery Access	
2	AC Input and Fuse The AC power connection is where facility line power is connected to this monitor, the AC power fuses must be replaced with the same type and rating fuse.	100/240V~50/60Hz, 30VA, F2AL 250V
3	Equipotential Grounding Solve the ground loop and mains problem by designing several alternate courses for electrical energy to finds its way back to ground.	

## SYMBOLS

The following symbols may appear on the packaging, monitor or in user's manual:

	Type BF Applied Part
<b>SN</b>	Manufacture's Serial Number
	Fuse Information
	Date of Manufacture
	Manufacturer
	Fragile Contents of the transport package are fragile therefore it shall be handled with care.
	This Way Up Indicates correct up right position of the transport package.
	Keep Away From Rain Transport package shall be kept away from rain.
	Stacking Limit By Number Maximum number of identical packages which may be stacked on one another is eight.
	General Warning, Caution, Risk Of Danger Please read the instructions carefully before operating the product.
	Stand-by To identify the switch or switch position by means of which part of the equipment is switched on in order to bring it into the stand-by condition.
	Prescription Only To be sold by or on the order of a physician only.
	To signify that the instruction manual/booklet must be read
	Separate collection for waste of electrical and electronic equipment. Do not dispose of battery in municipal waste. The symbol indicates separate collection for battery is required.
	Indicates the temperature limits to which the medical device can be safely exposed

User's manual of CLEO Patient Monitor

	Indicates the range of humidity to which the medical device can be safely exposed
<b>IPX1</b>	IPX1: N1=X, which means it was not required; N2=1, Protection against vertically falling water drop
<b>Rx Only</b>	Caution: Federal law (USA) restricts this device to sale by or on the order of a licensed healthcare practitioner.
	A marking by which a manufacturer indicates that a device is in conformity with the applicable requirements set out in this Regulation and other applicable Union harmonization legislation providing for its affixing

## DISPLAY SCREEN PARTITION

There are six groups for module combination in all. The user can choose what to measure as required in Module Select Menu.

The combination is as below:

- ◆ SpO<sub>2</sub>
- ◆ EtCO<sub>2</sub>
- ◆ SpO<sub>2</sub> + EtCO<sub>2</sub>
- ◆ SpO<sub>2</sub> + NBP
- ◆ SpO<sub>2</sub> + NBP + EtCO<sub>2</sub>
- ◆ SpO<sub>2</sub> + NBP

The display interface is as below:

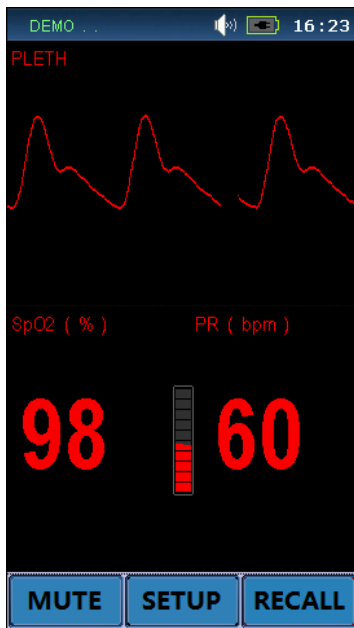

① Single SpO<sub>2</sub>

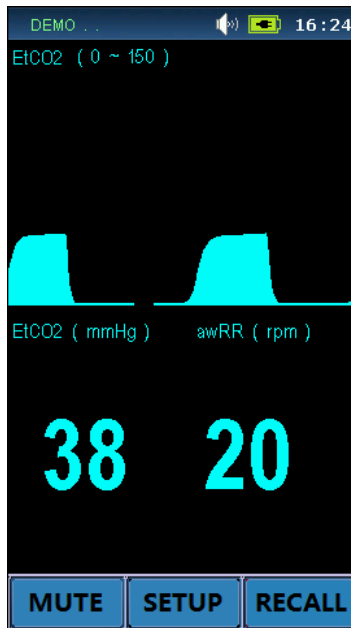

② Single EtCO<sub>2</sub>

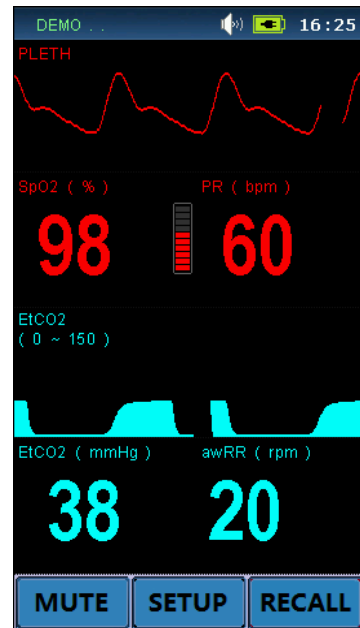

③ SpO<sub>2</sub> + EtCO<sub>2</sub>

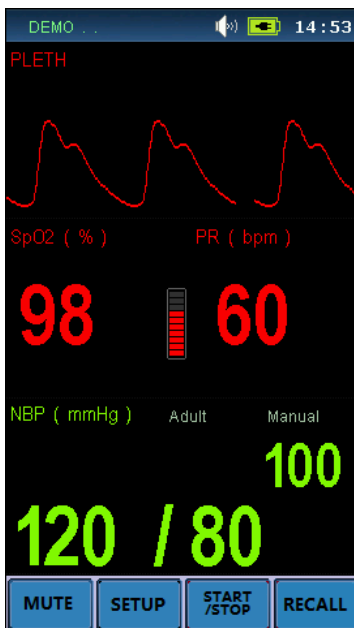

④ SpO<sub>2</sub> + NBP



⑤ SpO<sub>2</sub> + NBP + EtCO<sub>2</sub>

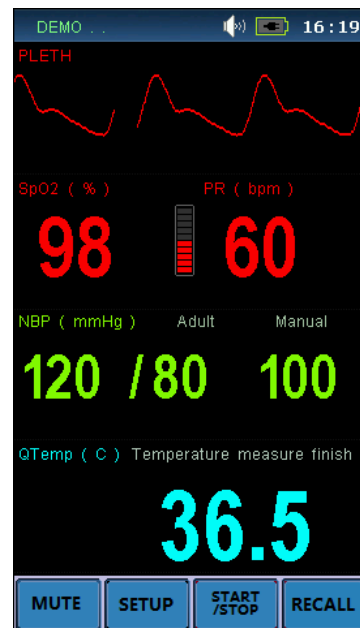

⑥ SpO<sub>2</sub> + NBP

### SINGLE SPO2 DISPLAY

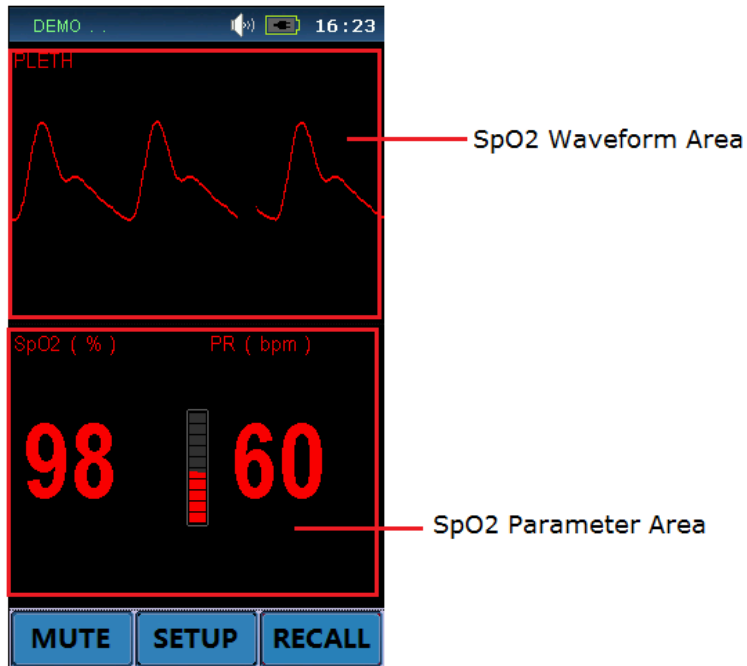

Figure 3: Single SpO<sub>2</sub> Display Screen

### SINGLE ETCO2 DISPLAY

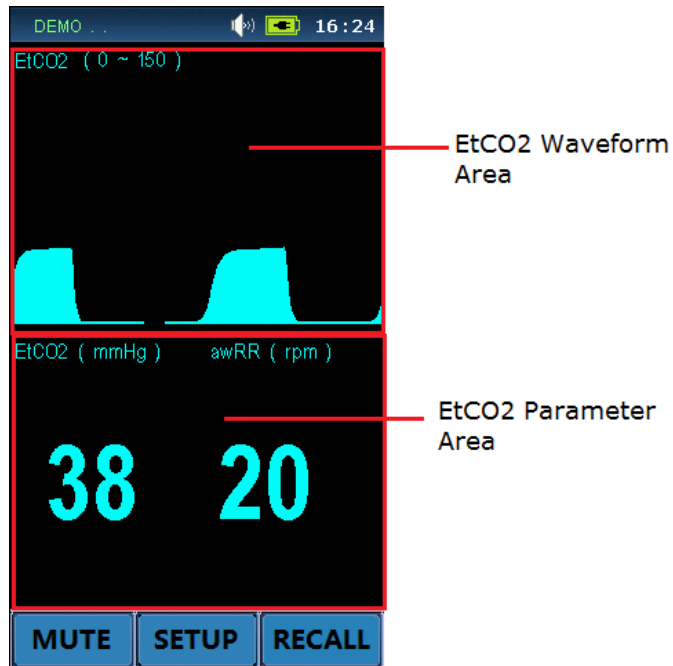

Figure 4: Single EtCO<sub>2</sub> Display Screen

### SPO2+ETCO2 DISPLAY

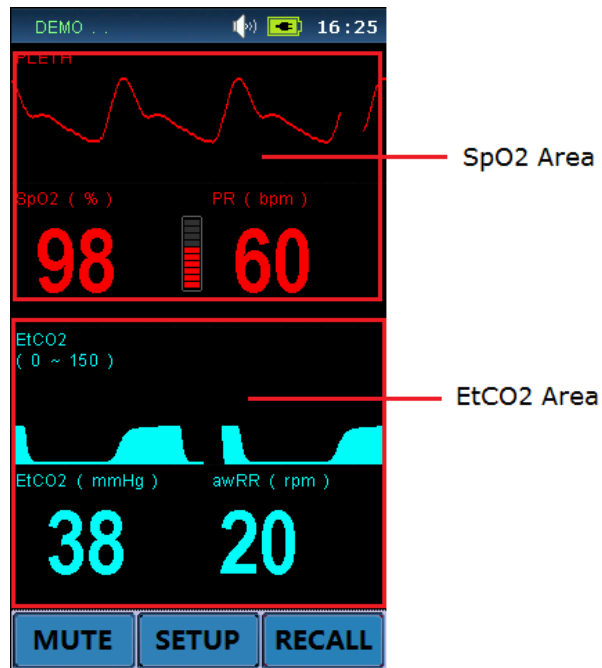

Figure 5: SpO<sub>2</sub> and EtCO<sub>2</sub> Display Screen

### SPO2+NBP DISPLAY

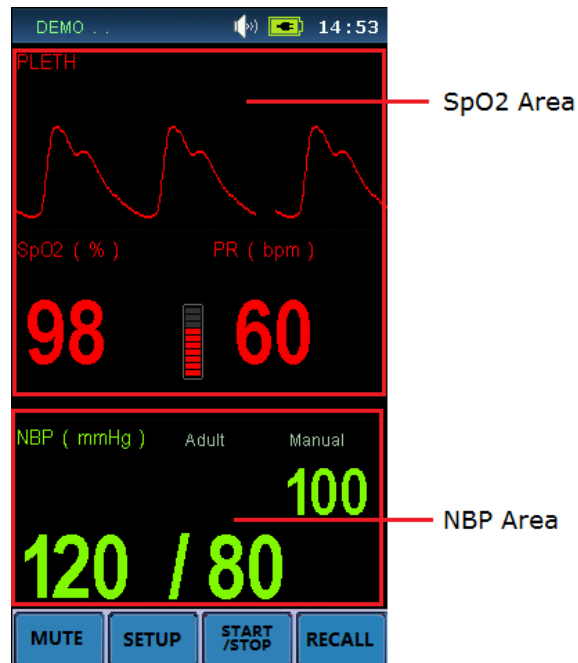

Figure 6: SpO<sub>2</sub> and NBP Display Screen

### SPO2 +NBP+ETCO2 DISPLAY

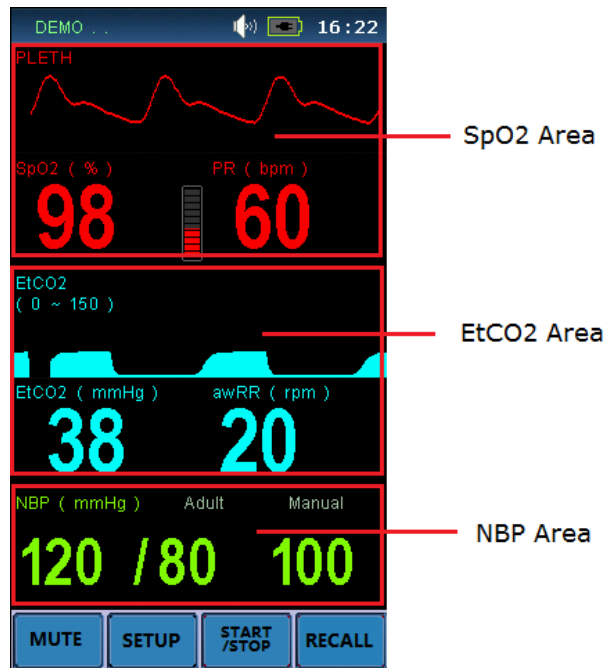

Figure 7: SpO<sub>2</sub>, EtCO<sub>2</sub> and NBP Display Screen

### SPO2+NBP DISPLAY

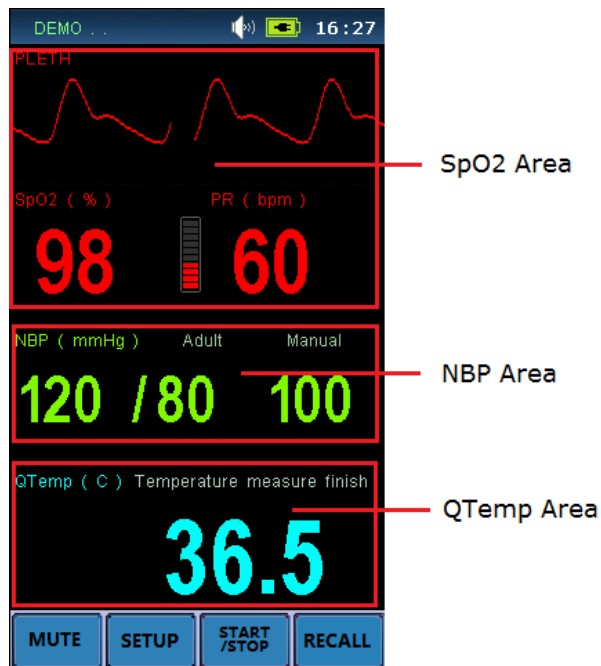
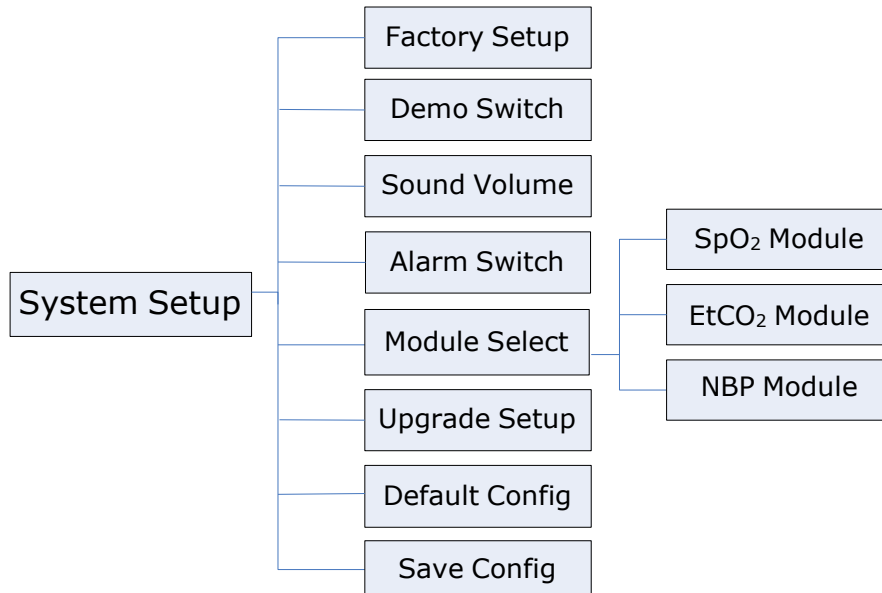

Figure 8: SpO<sub>2</sub>, NBP and Display Screen

## SYSTEM SETUP

System Setup includes: Factory Setup, Demo Switch, Sound Volume, Alarm Switch, Module Select, Default Config, Save Config and etc.

Press the button of **SETUP** to pop the System Setup menu, the tree diagram is as below:



**Figure 9: Tree Diagram for System Setup Menu**

## FACTORY SEVICING SETUP

Servicing engineer use only.

1. If input IPSETUP for the password, the “Upgrade Setup” menu item would be replaced by “IP Address Setup” menu item. And then enter the IP Setup submenu, Patient Monitor will pop out as following:



**Figure 10: Window for Ethernet IP Address Setup**

If click OK item, the Ethernet IP address setup of the Patient Monitor is set and saved. This IP address is available only when the patient monitor is re-powered on.

2. If input DEMO... for the password and then open the Demo Switch, you will see the

simulation measurement.

The Demo mode is for demonstration purpose only. To avoid that the simulated data are mistaken for the monitored patient's data, you must not change into demo mode during monitoring, otherwise, improper patient monitoring and delayed treatment could result.

This function is for servicing engineer only.

3. If input UPGRADE for the password, the Upgrade Setup Menu will be enable.  
This function is for servicing engineer only.

## **SOUND VOLUME**

Mainly use to adjust the sound to four levels, separately they are: I, II, III, IV. Also it can be set to OFF.

## **ALARM SWITCH**

It could be choose ON or OFF. When it is ON, the alarm is enabled, and then you should set the each parameter's alarm switch in the Parameter Setup. When it is OFF, the alarm is disabled which means all alarm is closed.

## **MODULE SELECT**

Choose what module is to open as you want.

## **DEFAULT CONFIG**

If the parameter settings are confused on irrational, you can call the Default Config to recover original state. The screen will display a menu to let you confirm the setup.

After return to the above confirmation menu, a message of "Load Successfully!" will display in the message highlight area, showing that the system has begun to work with the new settings.

## **SAVE CONFIG**

You can change monitor settings as required and then save the changed settings. The screen will display a menu to let you confirm the setup:

After return to the above confirmation menu, a message of "Save successfully" will display in the message highlight area, showing that the system and all monitoring parameter settings have been saved (see each chapter).

### **[NOTE]**

Make sure that the changes are suitable for your patient.

## HOW TO MONITOR

1. According to the parameter needed, connect the correlated sensors to the sockets at the bottom of the panel;
2. Connect with the power supply, press the power switch in the front panel;
3. Power indicator is bright, the display screen enter the main screen after 10 seconds;
4. Connect the detector with the patient;
5. Set monitoring parameters (see chapters below) ;
6. Enter the monitoring state.

**[CAUTION]:** If the CLEO is to be stored for a period of 2 months or longer, notify service personnel to remove the battery from the monitor prior to storage. Recharge the battery when the battery has not been recharged for 2 or more months.

**[CAUTION]:** Follow local government ordinances and recycle instructions regarding disposal or recycling of device components, including batteries.

## ALARM & SOUND

### ALARM

When the monitor detects certain conditions that require user attention, the CLEO Patient Monitor enters an alarm state. The monitor response is indicated by:

- Visual alarm indicators
- Audible alarm indicators

### ALARM PRIORITY

The monitor's visual and audible responses to a detected alarm depend on the priority of the alarm; High, Medium, or Low.

A higher priority alarm will supersede a lower priority alarm.

The three categories of alarms are summarized in the following paragraphs.

#### High Priority

Indicating that immediate OPERATOR response is required:

No breath (4 seconds have passed with no breath from EtCO<sub>2</sub>)

#### Medium Priority

Indicating that prompt OPERATOR response is required:

High/Low numeric value limits violated (such as High/Low SpO<sub>2</sub> limits violated, High/Low Sys./Dia. blood pressure limits violated, High/Low Temperature limits violated, etc.).

#### Low Priority

Indicating that OPERATOR awareness is required:

Module communicates error (such as SpO<sub>2</sub> com error).

Sensor off (Such as SpO<sub>2</sub> sensor disconnect, temperature probe disconnect, etc.)

### VISUAL ALARM INDICATORS

When an alarm occurs, the CLEO responds with visual alarm indications. The flashing rates for the three categories of alarms are shown. The CLEO uses flashing colors to indicate high and medium priority alarm as following Flashing Rates.

Alarm Category	Flashing Rate
High Priority	Two flashes in 1 second
Medium priority	One flash in 2 seconds
Low priority	Constant (on) (non-flashing)

When a low priority alarm occurs, a non-flashing alarm message appears in the message area. If more than one low priority alarm is present, the alarm messages "rotate". On the CLEO the alarm led color will change to a solid yellow for a low priority alarm

A medium priority alarm is activated when a parameter is outside its alarm limits, the out-of-limit numeric value and the bell icon in the corresponding Numeric Frame flash at the medium priority rate. Only the numeric frame background color will flash yellow for a medium priority alarm in the CLEO.

When the high-priority No breath alarm occurs, the alarm led color will flash red. A non-flashing No breath message appears in the message area and will override any other messages which may be present (there is no message "rotation" in this instance).

## SOUND

### ALARM SOUND

Like the mild sound of BEEP. There are four items of I , II , III and IV for alarm levels in turn from low to high.

The following encoded auditory alarm signals categorized by alarm condition and priority:

Alarm Category	Encoded Auditory
High Priority	c c c-c c
Medium priority	c c c
Low priority	e C

**[NOTE 1]:** The characters c,e refer to relative musical pitches and C is one octave c.  
**[NOTE 2]:** A high priority alarm signal is generated with the five pulses, repeat once, for total of 10 pulses.

### PULSE-TONE

The pulse-tone is a sound of RUB-A-DUB.

### KEY BEEPS

The key beep sounds come along with clicking function items.

### MUTE

Click this soft-key to enable or disable all sounds. A symbol of  will display in the message area. Also the user can set the Sound Volume to OFF which disable all sounds.

**[WARNING]:** Do not silence the audible alarm or decrease its volume if patient safety could be compromised.

**WARNING:** Each time the monitor is used; check alarm limits to ensure that they are appropriate for the patient being monitored.

## SPO2 MONITORING

- SPO2 MONITORING PRINCIPLE
- SPO2 SENSOR INSTALLATION
- SPO2 WAVEFORM SETUP
- SPO2 PARAMETER SETUP
- MEASUREMENT LIMITATIONS
- SPO2 ERROR MESSAGES
- NELLCOR INFORMATION

### SPO2 MONITORING PRINCIPLE

Arterial oxygen saturation is measured by a method called pulse oximetry. It is a continuous, non-invasive method based on the different absorption spectra of reduced hemoglobin and oxyhemoglobin. It measures how much light, sent from light sources on one side of the sensor, is transmitted through patient tissue (such as a finger or an ear), to a receiver on the other side.

The amount of light transmitted depends on many factors, most of which are constant. However, one of these factors, the blood flow in the arteries, varies with time, because it is pulsating. By measuring the light absorption during a pulsation, it is possible to derive the oxygen saturation of the arterial blood. Detecting the pulsation gives a PLETH waveform and pulse rate signal.

#### About SpO<sub>2</sub>, SaO<sub>2</sub>

- SpO<sub>2</sub>: It is the arterial blood oxygen saturation level measured by oximeter.
- SaO<sub>2</sub>: It is the oxygen saturation of arterial blood

#### [WARNING]

Pulse oximeter can overestimate the SpO<sub>2</sub> value in the presence of HB-CO, Met-HB or dye dilution chemicals.

### SPO2 SENSOR INSTALLATION

1. Insert the plug of SpO<sub>2</sub> sensor into the SpO<sub>2</sub> socket at the bottom of panel of monitor. Make sure that the salient of plug must direct to the notch of socket when inserting of unplugging, otherwise the measurement will not be reliable and the sensor connector will be damaged.
2. Wear the finger-probe on the finger; make sure that the finger tip is the same direction as the finger direction indicated on the probe.

### SPO2 WAVEFORM SETUP

Touch the SpO<sub>2</sub> Waveform area directly. The tree diagram is as below:

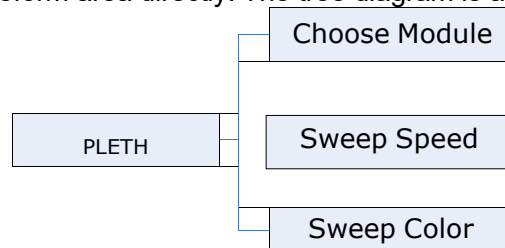

**Figure 11: Tree Diagram for Pleth Menu**

The menu can finish settings as below:

**CHOOSE MODULE**

There is one SpO<sub>2</sub> modules for choice: Nellcor.  
 More detail please contact with local distributor or service engineer

**SWEEP SPEED**

Choose from 12.5mm/s to 25.0mm/s, and the factory-set is 25 mm/s.

**SWEEP COLOR**

From Yellow, White, Blue, Red, Green and Cyan for choice, the default-set is Red.

**SPO2 PARAMETER SETUP**

Touch the SpO<sub>2</sub> Parameter area directly. As graph below:

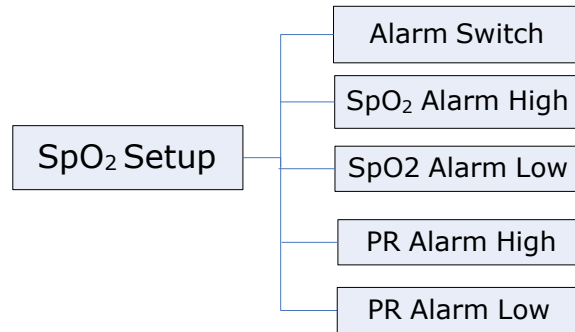
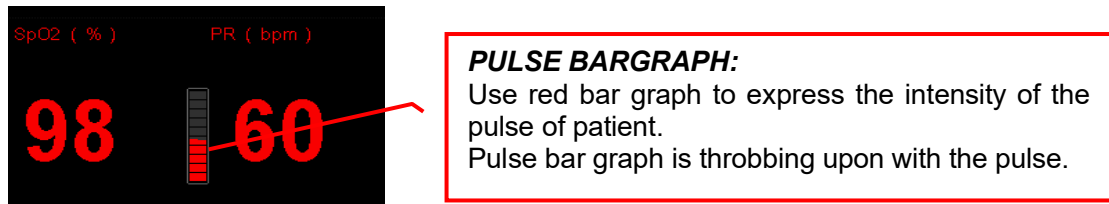

**Figure 12: Tree Diagram for SpO<sub>2</sub> Setup Menu**

**ALARM SWITCH**

ON and OFF for choice, the factory-set is ON.  
 If the SpO<sub>2</sub> value is above or below the SpO<sub>2</sub> alarm limit, when the choice is ON, the alarm is activated; when the choice is OFF, the alarm sound will be forbidden, the alarm indicator will not light and the relative alarm parameter will not flash.

**SPO2 ALARM HIGH**

The SpO<sub>2</sub> alarm upper-limit, the range is 50~99 %, and the factory-set is 99%, the single-step adjustable step- length is 1 %.

**SPO2 ALARM LOW**

The SpO<sub>2</sub> alarm lower-limit, the range is 50~99 %, and the factory-set is 85%, the single-step adjustable step- length is 1%.

**PR ALARM HIGH**

The PR alarm upper-limit, the range is 30~249 bpm, and the factory-set is 130 bpm, the single-step adjustable step- length is 1 %.

**PR ALARM LOW**

The PR alarm lower-limit, the range is 30~150 bpm, and the factory-set is 50 bpm, the single-step adjustable step- length is 1%.

## MEASUREMENT LIMITATIONS

1. The measurement is decided by the pulsating characteristic of blood stream in artery or arterial blood vessel. The arterial blood stream may decreased to the level which cannot be measured in conditions below:
  - Shock
  - Hypothermia
  - Vasoactive medicines are applied
  - Anemia
2. The measurement are also decided by the condition how the oxyhemoglobin and reduced-hemoglobin absorb the light of special wave-length. If there are other material can absorb the same wave-length light, they can cause the measurement false or lower than the actual value of SpO<sub>2</sub>, for example:
  - Carboxyhemoglobin
  - Methemoglobin
  - Methylene blue
  - Carmine indigo
3. The strong light in the environment also can influent measurement. Some suitable light-tight material to cover the sensor which can improve the measure quality.

### **[WARNING]**

- Prolonged and continuous monitoring may increase jeopardy of unexpected change of dermal condition such as abnormal sensitivity, rubescence, vesicle, repressive putrescence, and so on. It is especially important for a patient of poor perfusion or immature dermogram to check the sensor placement by light collimation and proper attaching strictly according to changes of the skin. Check regularly the sensor placement and move it when the skin deteriorates. More frequent examinations may be required for different patients.
- DO NOT use SpO<sub>2</sub> sensors during magnetic resonance imaging (MRI). Induced current could potentially cause burns. The sensor may affect the MRI image, and the MRI unit may affect the accuracy of the oximetry measurements.

## SPO2 ERROR MESSAGES

PLETH Waveform may display messages as below:

PROMPTS	EXPLANATION
Search Too Long	Search-time of SpO <sub>2</sub> is too long
Searching For Pulse. . .	On searching for pulse signal
Sensor Off	Sensor falls off or the finger fails to insert into the finger-probe
SpO <sub>2</sub> Com Error	SpO <sub>2</sub> board has communication error with the mainboard

## NO IMPLIED LICENSE

Possession or purchase of this device does not convey any express or implied license to use the device with unauthorized sensors cables which would, alone, or in combination with this device, fall within the scope of one or more of the patents relating to this device.

### **[WARNINGS]**

- Pulse rate measurement is based on the optical detection of a peripheral flow pulse and therefore may not detect certain arrhythmias. So it should not be used as a replacement or substitute for ECG based arrhythmia analysis.
- CLEO Patient Monitor should be considered an early warning device. As a trend towards patient deoxygenation is indicated, blood samples should be analyzed by a laboratory co-oximeter to completely understand the patient's condition.
- Interfering Substances: Carboxyhemoglobin may erroneously increase readings. The level of increase is approximately equal to the amount of carboxyhemoglobin present. Dyes or any substance containing dyes that change usual arterial pigmentation may cause erroneous readings.

## MEASUREMENTS

If the accuracy of any measurement does not seem reasonable, first check the patient's vital signs by alternate means and then check the MS board for proper functioning.

### **Incorrect measurements may be caused by:**

- Incorrect sensor application or use
- Significant levels of dysfunctional hemoglobins. (e.g., carboxyhemoglobin or methemoglobin)
- Intravascular dyes such as indocyanine green or methylene blue.
- Interfering Substances: Dyes, Nail polish or any substance containing dyes that change usual blood pigmentation may cause erroneous readings.
- Exposure to excessive illumination, such as surgical lamps (especially ones with a xenon light source), bilirubin lamps, fluorescent lights, infrared heating lamps, or direct sunlight (exposure to excessive illumination can be corrected by covering the sensor with a dark or opaque material)
- Excessive patient movement.
- SpO<sub>2</sub> is empirically calibrated to functional arterial oxygen saturation in healthy adult volunteers with normal levels of carboxyhemoglobin (COHb) and methemoglobin (MetHb). The monitor cannot measure elevated levels of COHb or MetHb. Increases in either COHb or MetHb will affect the accuracy of the SpO<sub>2</sub> measurement.
- Venous pulsations may cause erroneous low readings (e.g. tricuspid valve regurgitation).
- Patient suffers from abnormal pulse rhythm.
- Motion artifact may lead to inaccurate measurements.
- Elevated levels of Total Bilirubin may lead to inaccurate SpO<sub>2</sub> measurements..
- With very low perfusion at the monitored site, the readings may read lower than core arterial oxygen saturation.
- Do not immerse the sensor or patient cable in water or, solvents, or cleaning solutions (The sensors and connectors are not waterproof).
- Placement of a sensor on an extremity with a blood pressure cuff, arterial catheter, or intravascular line.

### **Loss of pulse signal can occur in any of the following situation:**

- The sensor is too tight.
- There is excessive illumination from light sources such as a surgical lamp, a

- bilirubin lamp, or sunlight.
- A blood pressure cuff is inflated on the same extremity as the one with a SpO<sub>2</sub> sensor attached.
- The patient has hypotension, severe vasoconstriction, severe anemia, or hypothermia.
- There is arterial occlusion proximal to the sensor.
- The patient is in cardiac arrest or is in shock.

## **SENSORS**

- Tissue damage can be caused by incorrect application or use of an LNOP® / LNCS® sensor, for example by wrapping the sensor too tightly. Inspect the sensor site as directed in the sensor Directions for Use to ensure skin integrity and correct positioning and adhesion of the sensor.
- Do not use damaged LNOP® / LNCS® sensors. Do not use an LNOP® / LNCS® sensor with exposed optical components. Do not immerse the sensor in water, solvents, or cleaning solutions (the sensors and connectors are not waterproof). Do not sterilize by irradiation, steam, or ethylene oxide..

## **NELLCOR INFORMATION**

### **TRADEMARK AND LICENSING LABELS**



### **NELLCOR PATENS**

This device is covered under one or more the following U.S. Patents: 4,802,486; 4,869,254;4,928,692; 4,934,372; 5,078,136; 5,351,685; 5,485,847; 5,533,507; 5,577,500; 5,803,910;5,853,364; 5,865,736; 6,083,172; 6,463,310; 6,591,123; 6,708,049; Re.35,122 and international equivalents U.S.A international patents pending.

### **NO IMPLIED LICENSE**

Possession or purchase of this device does not convey any express or implied license to use the device with unauthorized replacement parts which would, alone, or in combination with this device, fall within the scope of one or more of the patents relating to this device.

## NIBP MONITORING

- SUMMARY ON NIBP MONITORING
- NIBP CUFF FITTING
- NIBP MONITORING INITIALIZATION
- NIBP PARAMETER SETUP
- NIBP LIST OBSERVATION
- MEASUREMENT LIMITATIONS
- NIBP ERROR MESSAGES
- MAINTAINENCE AND CLEANING

### SUMMARY ON NIBP MONITORING

The Non-invasive Blood Pressure (NIBP) module measures the blood pressure using the oscillometric method.

It is applicable for **adult** usage only.

There are three modes of measurement available: **Manual**, **Automatic** and **Stat**. Each mode displays the diastolic *and* systolic blood pressure.

#### **[WARNING]**

- You must not perform NIBP measurements on patients with sickle-cell disease or under any condition which the skin is damaged or expected to be damaged.
- For a thrombasthenia patient, it is important to determine whether measurement of the blood pressure shall be done automatically. The determination should be based on the clinical evaluation.
- Before starting a measurement, verify that you have selected a setting appropriate for your patient (adult only)
- DO NOT apply the cuff to a limb that has an intravenous infusion or catheter in place. This could cause tissue damage around the catheter when infusion is slowed or blocked during cuff inflation.

### NIBP CUFF FITTING

1. Whether choosing the suitable cuff which match the arm of patient influent much on the accuracy of NIBP measurement. The cuff width recommend by **AMERICA HEART SOCIETY** is the 40% of upper arm circumference.
2. Apply the blood pressure cuff to the patient's arm:
  - Make sure that the cuff is completely deflated.
  - Apply the appropriate size cuff to the patient, and make sure that the symbol "φ" is over the appropriate artery. Ensure that the cuff is not wrapped too tightly around the limb. Excessive tightness may cause discoloration and eventual isocheimal of the extremities.
3. Make sure that the cuff has not been twisted. ◦
4. Insert the air pipe into the **NIBP** socket on the left panel of monitor. Ensure that the spring block on the left side of socket has been pressed when inserting or unplugging the pipe, otherwise the measurement process will be irregular and the sensor connector will be damaged.

**[WARNING]**

- The width of the cuff should be 40% of the limb circumference. The inflatable part of the cuff should be long enough to encircle 50-80% of the limb. The wrong size of cuff can cause erroneous readings. If the cuff size is in question, then use a larger cuff.
- Make sure that the cuff edge falls within the range of <-> . If does not, change a more suitable cuff.
- Connect the cuff to the air hose. The cuff chosen for taking the measurement should be placed at the same level as the patient's heart. If this is not possible you should apply the following corrections to the measured values:

**NIBP MONITORING INITIALIZATION**

After opening the host machine, check the information indicating area before NIBP monitoring, if there is a note of NIBP MODULE SELF-CHECK OK, it shows that the NIBP module operate well, then begin NIBP monitoring, and the NIBP monitoring before this information is invalid; if there is NIBP MODULE SELF-CHECK ERROR, it shows that the NIBP module cannot be proceeded, press the button of **START/STOP** to give another time of self-checking or machine-opening, if it is also this information, contact with servicing engineer.

**NIBP PARAMETER SETUP**

Touch the NIBP Parameter Area to pop the NIBP Setup menu.

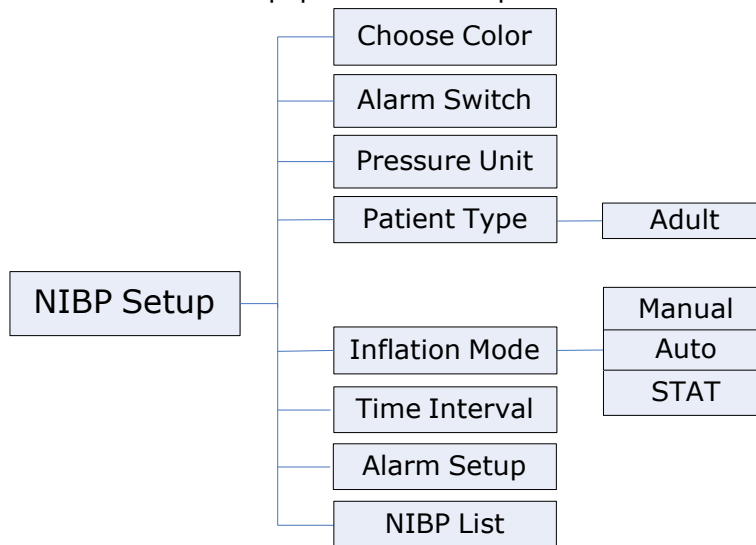

**Figure 13: Tree Diagram for NIBP Setup Menu**

This menu can finish settings below:

**DISPLAY COLOR**

From Yellow, White, Blue, Red, Green and Cyan for choice, the default-set is Green.

**ALARM SWITCH**

**ON** and **OFF** for choice, the factory-set is ON.

If the NIBP value is above or below the NIBP alarm limit, when the choice is ON, the alarm is activated; when the choice is OFF, the alarm sound will be forbidden, the alarm indicator will not light and the relative alarm parameter will not flash.

## **PRESSURE UNIT**

**mmHg** or **kPa**, the factory-set is **mmHg**.

## **PATIENT TYPE**

### **ADULT TYPE**

In the initiated measurement, inflate the cuff to 180mmHg (24kPa), if the NIBP value cannot be measured, then inflate the cuff to higher than the form value by 50mmHg (6.7kPa), the maximum value cannot exceed 280mmHg (37.3kPa), and the enduring pressure range is 50-280mmHg. The factory-set is ADULT TYPE.

If this setup is before the NIBP module initiation, information indicating area will give a message of PATIENT TYPE SET ERROR.

Inflating range shown above has been realized on NIBP, NIBP uses this inflation range to make sure the safety of patient.

## **INFLATION MODE**

There are three items for choice. Manual, Auto and STAT.

### **MANUAL MODE:**

Press the button of **START/STOP** to begin inflation, the information indicating area display "Manual measuring..." which shows that it is on measurement just the moment.

If the NIBP measurement is finished, NIBP parameter area will display values and the information indicating area will give a note of "Manual measuring end!", then the measurement process finished.

If the NIBP value cannot be measured, NIBP parameter area will display error messages and automatically begin three times of measurement again, if the value cannot be measured as well, the information indicating area will give a note of "RETRY OVER" and never measure again.

During the measurement, press the button of **START/STOP** again will stop the NIBP measurement process and the information indicating area will give a note of STOP MANUAL MEASURING.

### **AUTOMATIC MODE**

NIBP parameter area will display the countdown of "Auto measuring..." (TIME INTERVAL), so long as reaching the zero point, machine will automatically precede inflating measurement again and again until the mode is changed.

Start a measurement manually. The monitor will then automatically repeat NIBP measurements at the set time interval.

If the NIBP measurement is finished, NIBP parameter area will display values and the information indicating area will give a note of "Auto measuring end! ". And then begin another measurement until the mode is changed.

If the NIBP value cannot be measured, NIBP parameter area will display error messages and the first measurement automatically begin three times of measurement again, if the value cannot be measured as well, the information indicating area will give a note of "RETRY OVER" and automatically go on the next measurement until the mode is changed. If the button of **START/STOP** be pressed during any period of countdown, it is immediately begin inflation measurement.

During the measurement, press the button of **START/STOP** again will stop this period of NIBP measurement process and the information indicating area will give a note of "Stop auto measuring", but the automatic measurement period is continuous.

**[WARNING]**

Prolonged non-invasive blood pressure measurements in Auto mode may be associated with purport, isocheimal and neuropathy in the limb wearing the cuff. When monitoring a patient, examine the extremities of the limb frequently for normal color, warmth and sensitivity. If any abnormality is observed, stop the blood pressure measurements.

**STAT MODE**

In the stat mode, it will measure NIBP continually for three times. And then it will end automatically. Of course, you can press the button of **START/STOP** to end the measurement manually.

Press the button of **START/STOP** to begin inflation, the information indicating area display "STAT measuring..." which shows that it is on measurement just the moment; If the NIBP measurement is finished, NIBP parameter area will display values and the information indicating area will give a note of "STAT measuring end".

If the NIBP value cannot be measured, NIBP parameter area will display error messages and automatically begin three times of measurement again, if the value cannot be measured also, the information indicating area will give a note of "RETRY OVER! ", and then continue another time of measurement which lasts 5 minutes and then stop.

During the measurement, if press the button of **START/STOP** again, the information indicating area will give a note of "STOP STAT TEST" to stop the NIBP measurement and exit from this mode.

**[NOTE]**

The value having been measured will display on the NIBP parameter area for 240 minutes unless a new measurement begin during this period. On the appropriate trend graph and trend table, the parameter will exist for correlated time length.

**TIME INTERVAL**

This setting is used supported by **automatic** inflation mode. You can input the time interval as you want. The range is 1 min to 4 hours.

**ALARM LIMIT SETUP**

<i>Limits</i> <i>Patient Type</i>	<i>SYS UPPER LIMIT</i> <i>(mmHg)</i>	<i>SYS LOWER LIMIT</i> <i>(mmHg)</i>	<i>DIA UPPER LIMIT</i> <i>(mmHg)</i>	<i>DIA LOWER LIMIT</i> <i>(mmHg)</i>
<b>Adult</b>	30~240 Factory-set:150	30~240 Factory-set:100	15~180 Factory-set:90	15~180 Factory-set:50

The single-step adjustable length of alarm limit above is 1 mmHg.

**NIBP LIST OBSERVATION**

Touch the "NIBP List" item area to pop up the NIBP List Tabular.

NO.	Time	SYS	DIA
1	06/01 14:31:40	120	80
2	06/01 14:31:22	120	80
3	06/01 14:31:02	120	80
4	06/01 14:30:43	120	80
5	06/01 14:30:24	120	80
6	06/01 14:30:05	120	80
7	06/01 14:29:46	120	80
8	06/01 14:29:27	120	80
9	06/01 14:29:08	120	80
10	06/01 14:28:49	120	80

**Figure 14: Window for NIBP List Observation**

The NIBP list can save 260 groups of data.

**[NOTE]:** Only after the NIBP value has been measured can it be added to the NIBP Data List. NIBP list can save 260 groups of data at all, if exceed, the new data will kick the most former data out of the list and be added to the list automatically.

## MEASUREMENT LIMITATIONS

To different patient conditions, the oscillometric measurement has certain limitations. The measurement is in search of regular arterial pressure. In those circumstances when the patient's condition makes it difficult to detect, the measurement becomes unreliable and measuring time increases. The user should be aware that the following conditions could interfere with the measurement, making the measurement unreliable or longer to derive. In some cases, the patient's condition will make a measurement impossible.

### PATIENT MOVEMENT

Measurements will be unreliable or may not be possible if the patient is moving, shivering or having convulsions. These motions may interfere with the detection of the arterial pressure pulses. In addition, the measurement time will be prolonged.

### CARDIAC ARRHYTHMIA`S

Measurements will be unreliable and may not be possible if the patient's cardiac arrhythmia has caused an irregular heartbeat. The measuring time thus will be prolonged.

### HEART-LUNG MACHINE

Measurements will not be possible if the patient is connected to a heart-lung machine.

### PRESSURE CHANGES

Measurements will be unreliable and may not be possible if the patient's blood pressure is changing rapidly over the period of time during which the arterial pressure pulses are being analyzed to obtain the measurement.

### SEVERE SHOCK

If the patient is in severe shock or hypothermia, measurements will be unreliable since reduced blood flow to the peripheries will cause reduced pulsation of the arteries.

### HEART RATE EXTREMES

Measurements cannot be made at a heart rate of less than 40 bpm and greater than 240 bpm.

## NIBP ERROR MESSAGES

Message indicating area may display messages like below:

Patient moving !	Serial error
Pressure < 10 mmHg!	NIBP renew self-check...
Pressure < 1.3 kPa!	NIBP self-check...
Pressure > 325 mmHg!	NIBP self-check error!
Pressure > 43.3 kPa!	NIBP inter error!
Serial overtime!	Patient type error!
Reset error!	Setup patient...
Zero reset error!	NIBP self-check ok!

## MAINTAINENCE AND CLEANING

**[NOTE]**

DO NOT squeeze the rubber tube on the cuff.

### REUSABLE BLOOD PRESSURE CUFF

The cuff can be sterilized by means of conventional autoclaving, gas or radiation sterilization in hot air ovens or disinfected by immersion in decontamination solutions, but remember to remove the bladder if you use this method. The cuff should not be dry-cleaned. The cuff can also be machine-washed or hand-washed; the latter method may prolong the service life of the cuff. Before washing, remove the latex bladder, and for machine-washing, close the Velcro fastening. Allow the cuff to dry thoroughly after washing, and then reinsert the rubber bag.

To replace the bladder in the cuff, first place the bag on top of the cuff so that the rubber tubes line up with the large opening on the long side of the cuff. Now roll the bag lengthwise and insert it into the opening on the long side of the cuff. Hold the tubes and the cuff and shake the complete cuff until the bag is in position. Thread the rubber tubes from inside the cuff, and out through the small hole under the internal flap.

Replace the bladder after cleaning and disinfecting the cuff, as follows:

1. Place the bladder on the top of the cuff, as the figure shows.
2. Roll the bladder lengthwise and insert it into the large opening. See the figures below.
3. Hold the hose and the cuff and shake the complete cuff until the bladder is in position.
4. Thread the hose from inside the cuff, and out through the small hole under the internal flap.

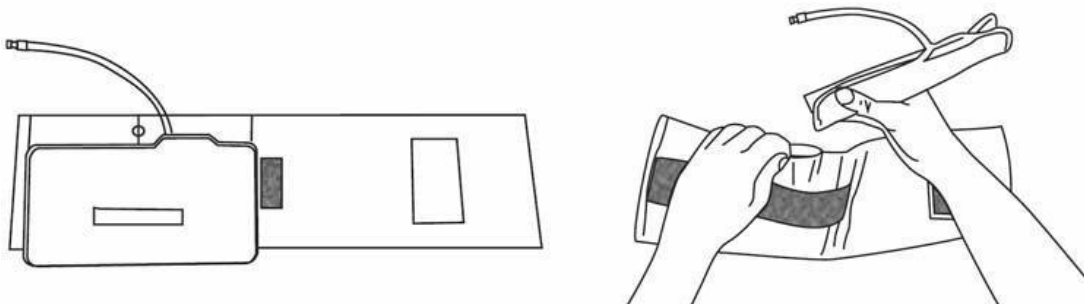

## ETCO<sub>2</sub> MONITORING

- THEORY OF OPERATION
- WARNINGS, CAUTIONS, NOTES
- ABBREVIATIONS AND TERMINOLOGY
- ZEROING THE CO<sub>2</sub> MODULE
- PATIENT AND TUBING PREPARATION
- ETCO<sub>2</sub> WAVEFORM SETUP
- ETCO<sub>2</sub> PARAMETER SETUP
- ADVANCED SETUP
- CALIBRATION
- STATUS/ERROR MESSAGES
- MAINTENANCE AND CLEANING

### THEORY OF OPERATION

Carbon dioxide monitoring system is a sidestream sampling system with a 50 ml/minute low sampling rate, which is used to monitor continuous carbon dioxide and display the End Tidal carbon dioxide (EtCO<sub>2</sub>), inspired CO<sub>2</sub> and respiratory rate values of the non-intubated and intubated adult patient, using specially designed sampling cannula and on-airway adapter kits. These kits incorporate a filter and the sample cell that provides maximum filtration of fluids and contaminants and protects the system from aspiration of these fluids.

In carbon dioxide monitoring system, infrared light is generated by the sensor and beamed through the sample cell to a detector on the opposite side. CO<sub>2</sub> from the patient that is aspirated into the sample cell absorbs some of this infrared energy. The monitor determines CO<sub>2</sub> concentration in the breathing gases by measuring the amount of light absorbed by these gases. EtCO<sub>2</sub> is displayed as a numerical value in millimeters of mercury (mmHg), percent (%), or kilopascals (kPa). In addition, a CO<sub>2</sub> waveform (capnogram) may be displayed which is a valuable clinical tool that can be used to assess patient airway integrity and proper endotracheal tube (ETT) placement. Respiration rate is calculated by measuring the time interval between detected breaths.

### WARNINGS, CAUTIONS AND NOTES

#### WARNINGS

- \* Explosion Hazard: DO NOT use in the presence of flammable anesthetics or other flammable gasses.
- \* Electrical Shock Hazard: Always disconnect the CO<sub>2</sub> module before cleaning. DO NOT use if it appears to have been damaged. Refer servicing to qualified service personnel.
- \* Failure of Operation: If the CO<sub>2</sub> module fails to respond as described in this user manual; DO NOT use it until approved for use by qualified personnel.
- \* DO NOT position the sensor cables or tubing in any manner that may cause entanglement or strangulation. Support the carbon dioxide monitoring system airway adapter to prevent stress on the ET tube.
- \* Reuse, disassembly, cleaning, disinfecting or sterilizing the single patient use cannula kits and on-airway adapters may compromise functionality and system performance leading to a user or patient hazard. Performance is not guaranteed if an item labeled as single patient use is reused.
- \* Inspect the sidestream on-airway adapters and sidestream sampling kits for damage prior to use. DO NOT use the sidestream on-airway adapters and sidestream sampling kits if they appear to be damaged or broken.
- \* Replace the sidestream on-airway adapters and sidestream sampling kits if excessive secretions are observed.
- \* Monitor the CO<sub>2</sub> check waveform (Capnogram). If you see changes or abnormal

- appearance the patient and the sampling line. Replace line if needed.
- \* DO NOT operate the CO<sub>2</sub> Module when it is wet or has exterior condensation.
  - \* DO NOT apply excessive tension to any cable.
  - \* DO NOT use device on patients that can not tolerate the withdrawal of 50 ml/min +/- 10 ml/min from the airway or patients that can not tolerate the added dead space to the airway.
  - \* DO NOT connect the exhaust tube to the ventilator circuit.
  - \* DO NOT use for measuring Xenon Gases
  - \* DO NOT use for measuring Helium Gases

### CAUTIONS

- \* DO NOT sterilize or immerse the CO<sub>2</sub> module in liquids.
- \* DO NOT store the CO<sub>2</sub> Module at temperatures less than -40° F (-40° C) or greater than 158° F (70° C).
- \* DO NOT operate the CO<sub>2</sub> Module at temperatures less than 32° F (0° C) or greater than 104° F (40° C).
- \* DO NOT stick appendage into sample receptacle.
- \* Always insert sample cell before inserting the on-airway adapter into the ventilated circuit.
- \* Always remove the on-airway adapter from the ventilated circuit before removing the sample cell.
- \* Nitrous oxide, elevated levels of oxygen, helium, Xenon, halogenated hydrocarbons, and barometric pressure can influence the CO<sub>2</sub> measurement. Levels to be supplied by the monitor.

### NOTES

- \* After the life cycle of the CO<sub>2</sub> module and its accessories has been met, disposal should be accomplished following national and/ or local requirements.

### ABBREVIATIONS AND TERMINOLOGY

EtCO <sub>2</sub>	End tidal carbon dioxide
INSP CO <sub>2</sub>	Inspired minimum CO <sub>2</sub>
AWRR	Air-way respiration rate
BARO	Barometric Pressure

### ZEROING THE CO<sub>2</sub> MODULE

The sample cell zero allows the CO<sub>2</sub> Module to adjust to the optical characteristics of the sample cell only when requested.

For optimal accuracy, a CO<sub>2</sub> Module zero should be performed whenever the CO<sub>2</sub> Module is connected to the patient monitor.

Before performing a CO<sub>2</sub> Module zero, the CO<sub>2</sub> Module should be removed from the patient monitor and the airway adapter type to be used in the circuit should be inserted into the CO<sub>2</sub> Module. Care should be taken ensure that the airway adapter is clear of any residual CO<sub>2</sub> gas. The maximum elapsed time for a CO<sub>2</sub> Module zero is 30 seconds. The typical time for a zero is 15 – 20 seconds.

Several CO<sub>2</sub> Module conditions may also request that a zero be performed. These requests stem from changes in the airway adapter that may indicate that the sensor is not in optimal measuring condition. When this occurs, the airway adapter should be checked to ensure optical occlusions such as mucus have not obscured the adapter window. If occlusions are found, the airway adapter should be cleaned or replaced.

**NOTES:**

- \* System does not allow adapter zero for 20 seconds after the last breath is detected.
- \* System does not allow adapter zero if temperature is not stable.
- \* An adapter zero cannot be performed if a sample cell is not connected to the module.
- \* For best results, wait 5 minutes to allow the CO<sub>2</sub> module to warm up before performing the Sample Cell Zero procedure.

**PATIENT AND TUBING PREPARATION**

**MODULE MOUNTING**

- a. Put the CO<sub>2</sub> module into the bracket of the rear panel of the monitor.
- b. Check that monitor is switched off, Insert the plug of CO<sub>2</sub> sensor into the corresponding sensor socket marked with **EtCO<sub>2</sub>** icon on the left panel of monitor.

**[WARNING]:** Don't hot plug EtCO<sub>2</sub> module, that is make sure that the CLEO is powered off before Insert the connector of CO<sub>2</sub> sensor into EtCO<sub>2</sub> socket. Otherwise the CO<sub>2</sub> module may be damaged by power supply from EtCO<sub>2</sub> socket of CLEO.

**CONNECTING THE SAMPLE KIT**

- a. The sample cell of the sampling kit must be inserted into the sample cell receptacle of the CO<sub>2</sub> Module as shown in following figure. A “click” will be heard when the sample cell is properly inserted.

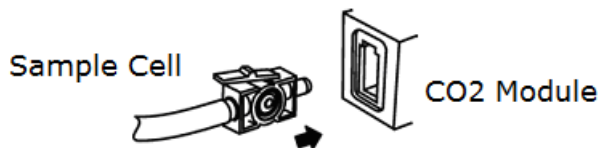

- b. Connect the CO<sub>2</sub> tubing to Nasal and Nasal/Oral Sidestream Kits.
- c. Inserting the sample cell into the receptacle automatically starts the sampling pump. Removal of the sample cell turns the sample pump off.
- d. To remove the sampling kit sample cell from the sample cell receptacle, press down on the locking tab and pull the sample cell from the sample cell receptacle.

**DIRECTIONS**

**For use of single patient use nasal and nasal/oral sidestream kits**

**CAUTION:** The Nasal and Nasal/Oral Cannula kits are intended for single patient use. Do NOT reuse or sterilize the cannula kit as system performance will be compromised.

1. Verify that the cannula kit is clean, dry and undamaged. Replace the cannula kit if necessary.
2. Insert the sample cell into the sample cell receptacle as shown in above figure on connecting the Sample Kit section. A “click” will be heard when properly inserted.
3. Perform a sample cell zero if prompted by the host system.
4. Place the nasal cannula kits onto the patient as shown in following figure.

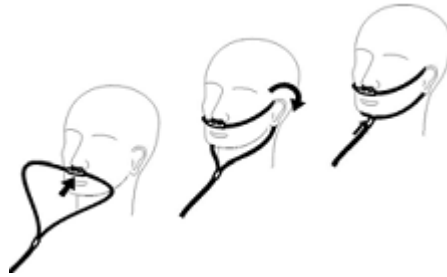

5. Some patients are prone to mouth breathing. The Oral/Nasal sampling cannula should be used on these patients, as most, if not all of the CO<sub>2</sub> is exhaled through the mouth. If a standard nasal CO<sub>2</sub> sampling cannula is used with these patients, the EtCO<sub>2</sub> number and capnogram will be substantially lower than actual.
6. When using the Nasal or Oral/Nasal CO<sub>2</sub> sampling kits with oxygen delivery, place the cannula on the patient as shown above and then attach the oxygen supply tubing to the oxygen delivery system and set the prescribed oxygen flow.
7. If the oral/nasal cannula is used, the oral sampling tip may need to be trimmed to adequately fit the patient (see following figure). Place the cannula onto the patient as shown in above figure. Observe the length of the oral cannula tip. It should extend down past the teeth and be positioned in the mouth opening. Remove the cannula from the patient if the tip needs to be trimmed.

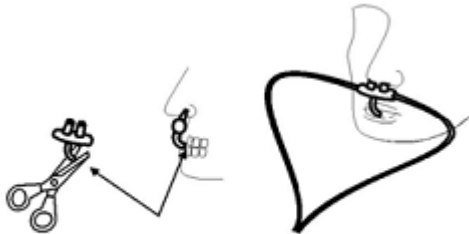

**[CAUTION]:**

- DO NOT cut the oral cannula tip when the cannula is on the patient.
- Remove the sampling kit sample cell from the CO<sub>2</sub> Module Inlet Port when not been use.

:

**FLOW RATE**

Conditions that can cause a change in Flow Rate:

- Water, mucous or other patient contaminate has entered the sample tubing.
- The sample tubing is crimped or pinched so that the sample flow rate has decreased.
- The exhaust port of the CO<sub>2</sub> module is obstructed.
- The sample line is damaged.
- The sample line has been cut, or split, causing the flow rate to increase.

**ETCO<sub>2</sub> WAVEFORM SETUP**

Touch the EtCO<sub>2</sub> Waveform Area to pop the menu of EtCO<sub>2</sub> Waveform Setup, see graph below:

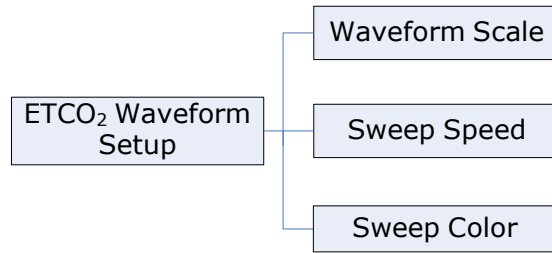

Figure 15: Tree Diagram for EtCO<sub>2</sub> Waveform Setup Menu

**WAVEFORM SCALE**

Use this setting to adjust the amplitude measurement (size) of the displayed EtCO<sub>2</sub> waveform scale manually. The label will be displayed in the screen. There are two items for choice: 0~75 mmHg, 0~150 mmHg.

**SWEEP SPEED**

From 6.25 mm/s, 12.5 mm/s and 25 mm/s for choice, the factory-set is 6.25mm/s.

**SWEEP COLOR**

From Yellow, White, Blue, Red, Green and Cyan for choice, the default-set is Cyan.

**ETCO2 PARAMETER SETUP**

Touch the EtCO<sub>2</sub> Parameter Area to pop the menu of EtCO<sub>2</sub> Parameter Setup, see tree diagram below:

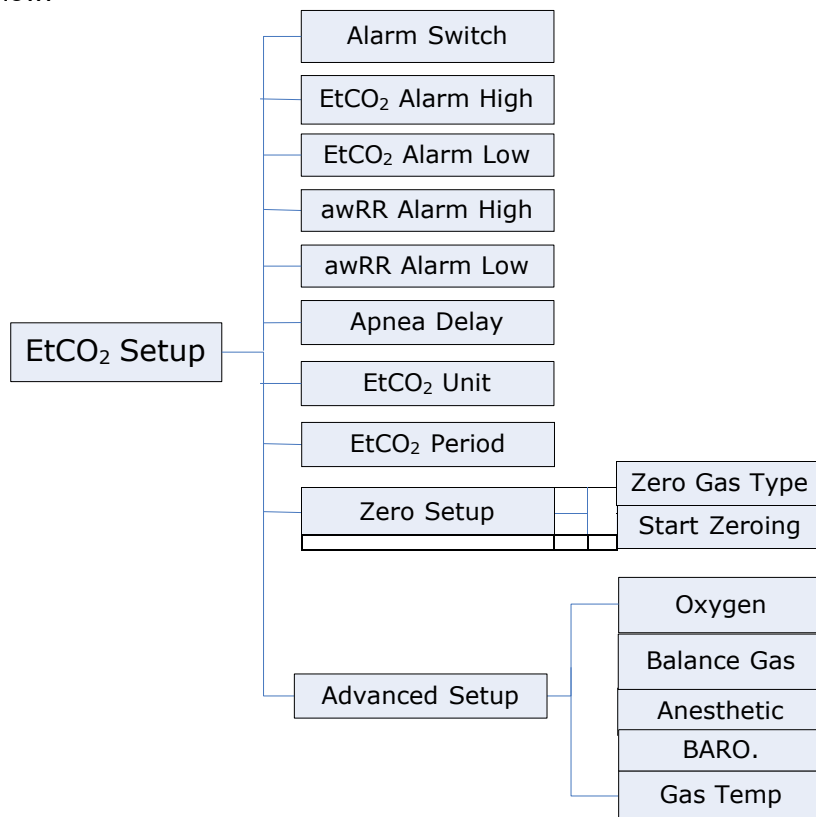

Figure 16: Tree Diagram for EtCO<sub>2</sub> Parameter Setup Menu

**ALARM SWITCH**

**ON** and **OFF** for choice, the factory-set is **ON**.

If the EtCO<sub>2</sub> or awRR value is above or below the alarm limit, when the choice is ON, the alarm is activated; when the choice is OFF, the alarm sound will be forbidden, the alarm indicator will not light and the relative alarm parameter will not flash.

### **ETCO2 ALARM HIGH**

The range is 20~100 mmHg, and the factory-set is 60 mmHg.

### **ETCO2 ALARM LOW**

The range is 1~95 mmHg, and the factory-set is 15 mmHg.

### **AWRR ALARM HIGH**

The range is 10~150 mmHg, and the factory-set is 30 mmHg.

### **AWRR ALARM LOW**

The range is 5~100 mmHg, and the factory-set is 5 mmHg.  
The single-step adjustable length of alarm limit above is 1 mmHg.

### **ASPHYXIA DELAY**

This setting is used to set the no breaths detected time-out. This time-out is the time period in seconds following the last detected breath at which the CO<sub>2</sub> module will signal no breaths detected. The monitor will alarm if the patient has stopped breathing for longer than the preset apnea time.

The setting range is 10~60 seconds, and the factory-set is 10 seconds.

### **ETCO2 UNIT**

mmHg, kPa or percent (%), the factory –set is mmHg.

### **ETCO2 PERIOD**

This setting is used to set the calculation period of the EtCO<sub>2</sub> value. The end-tidal CO<sub>2</sub> value is the highest peak CO<sub>2</sub> value of all ends of expirations (end of breaths) over the selected time period. If less than two breaths exist in the selected time period, the value will be the maximum EtCO<sub>2</sub> value for the last two breaths.

This setting has 1 breath, 10 seconds and 20 seconds for choice, the factory–set is 1 breath.

### **ZERO SETUP**

Zero steps refer to “Zeroing the CO<sub>2</sub> Module” section detailed.

Complete the zero procedure by press “**Start Zeroing**” item. During zeroing, a message of “EtCO<sub>2</sub> Zero Started” will be display on the message area.

**[NOTE]:** During the CO<sub>2</sub> module warm-up period after the monitor is powered on, the monitor will perform an automatic zero calibration. The maximum elapsed time for a CO<sub>2</sub> Module zero is 30 seconds. The typical time for a zero is 15 – 20 seconds.

### **ZERO GAS TYPE**

When performing a zero on room air, this setting should be set to room air (the default). Only change to nitrogen (N<sub>2</sub>) when performing a zero on 100% N<sub>2</sub> gas. This is provided for use in a laboratory environment.

### **ADVANCED SETUP**

Pick “**ADVANCED SETUP**” item to call up the related menu:

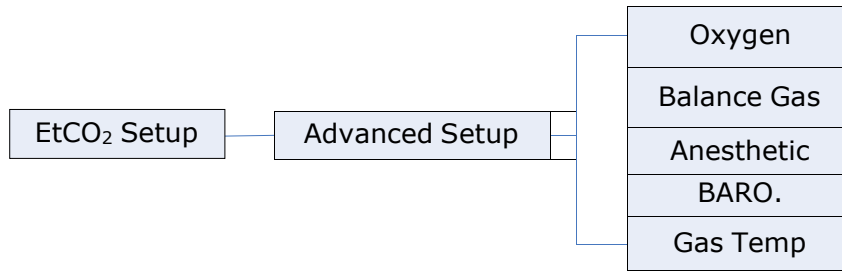

**Figure 17: Tree Diagram for EtCO<sub>2</sub> Advanced Setup**

**SET GAS COMPENSATIONS**

The measurement of CO<sub>2</sub> is affected by temperature, pressure, and gas compensations. The barometric pressure as well as the presence of O<sub>2</sub>, N<sub>2</sub>O, helium, and anesthetic agents in the gas mixture needs to be compensated for by the CO<sub>2</sub> module in order to achieve its stated accuracy. The instrument settings for these parameters should be set when initially connecting to the CO<sub>2</sub> module and whenever there is a change in the conditions at the patient airway.

In the CO<sub>2</sub> module, the temperature of the gas in the airway also effects the CO<sub>2</sub> measurement. It is necessary to adjust the instrument setting for the gas temperature to achieve the maximum accuracy for the CO<sub>2</sub> module.

**OXYGEN COMPENSATION**

The setting range is 0~100 %. The factory-set is 16 %.

**BALANCE GAS**

There are room air, N<sub>2</sub>O and Helium items to choose.

**ANESTHETIC AGENT (Not Cleared for USA)**

Use this setting to correct for the compensation of the gas mixture administered to the patient. Anesthetic agent is ignored when the balance gas is set to helium.

The setting range is 0.0~20.0 %. The factory -set is 0.0 %.

**[NOTE]:** At 700 mmHg of pressure, the correct CO<sub>2</sub> value is 35.0 mmHg.

**BAROMETRIC PRESSURE**

This setting is used to set current Barometric Pressure.

The setting range is 400~850 mmHg. The factory -set is 760 mmHg.

**GAS TEMPERATURE**

This setting is used to set temperature of the gas mixture. This setting is useful when bench testing using static gasses where the temperature is often room temperature or below.

The setting range is 0~50°C. The factory -set is 35°C.

**CALIBRATION**

No routine user calibration required.

Safety lock-outs:

- \* System does not allow sample cell zero for 20 seconds after the last breath is detected.
- \* System does not allow sample cell zero if temperature is not stable.
- \* An adapter zero cannot be performed if a sample cell is not connected to the module.

## STATUS/ERROR MESSAGES

Messages	Descriptions
Sensor Off	The CO <sub>2</sub> sensor is not connected
Sensor Warm Up	One of the following conditions exist: Sensor under temperature Temperature not stable Source Current unstable
Sensor Over Temp	Make sure sensor is not exposed to extreme heat (heat lamp, etc.). If error persists, return sensor to factory for servicing.
Sensor error	Check that the sensor is properly plugged in. Reinsert or reset the sensor if necessary. If error persists, return sensor to factory for servicing.
Sensor Zeroing. . .	A zero is currently in progress.
Zero Required	To clear, check airway adapter and clean if necessary. If this does not correct the error, perform an adapter zero. If you must adapter zero more than once, a possible hardware error may exist.
Check Sampling Line	To clear, clean if sampling line mucus or moisture is seen. If the sampling line is clean, perform a zero.
CO <sub>2</sub> Out of Range	The value being calculated is greater than the upper CO <sub>2</sub> limit (150 mmHg, 20.0 kPa, or 19.7 %). The maximum value output is the upper CO <sub>2</sub> .
Check Airway Adapter	To clear, clean airway adapter if mucus or moisture is seen. If the adapter is clean, perform a zero.
Pump Life Exceed	The manufacturer stated pump life has been exceeded. Service may be required if Pneumatic System Error is present and can no longer be cleared.
Sensor Setup. . .	The CO <sub>2</sub> sensor is setting process.
EtCO <sub>2</sub> Zero Error: Sensor Not Ready.	The CO <sub>2</sub> sensor is not ready for a EtCO <sub>2</sub> Zero
EtCO <sub>2</sub> Zero Error: Breath Detected.	Breaths have been detected by the CO <sub>2</sub> module within the last 20 seconds while a CO <sub>2</sub> module zero was attempted.

## MAINTENANCE AND CLEANING

### SCHEDULE

The CO<sub>2</sub> Module flow rate accuracy should be verified by direct measurement using a calibrated flow meter every 12 months.

### CLEANING

Cleaning the Sidestream On-Airway Adapters and Sidestream Sampling Kits:  
Sidestream on-airway adapters and sidestream sampling kits are single patient use. Treat in accordance with hospital protocols for handling single patient use devices.

## RECALL DATA

- PATIENT BASIC INFORMATION SETUP
- CLOCK SETUP
- HOW TO RECALL

### PATIENT BASIC INFORMATION SETUP

The user can set by touching the patient ID area at the top left corner to pop up patient setup menu. You can have settings as below. CLEO Patient Monitor can save five groups patient information for recall in total.

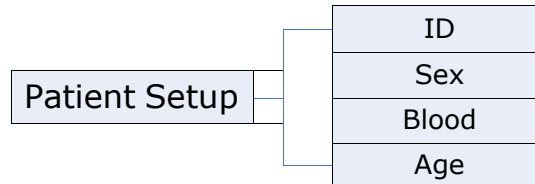

**Figure 18: Tree Diagram for Patient Setup**

#### ID

Set the ID number of patient. The ID number for each patient is different and unique. The user can input 12 characters at most.

**[NOTE]:** If you set the same ID with previous patient, the measurement data record will be saved following after the previous data with same ID.

#### SEX

Set the patient gender, the default setting is **MALE**.

#### BLOOD

Set the blood type of patient. It can be: **N/A**(unknown type) , **A** , **B** , **O** , **AB** , **RH+** , **RH-** and so on, the default setting is **N/A**.

#### AGE

Set the age of patient. The range is 0 ~120, the default setting is **25**.

**[NOTE]:** The Patient Monitor displays physiological data and stores them in the trends as soon as a patient is connected. This allows you to monitor a patient that is not saved information yet. However, it is recommended that you fully admit a patient so that you can clearly identify your patient, on recordings, reports and networking devices.

**[NOTE]:** Once the user chooses the method of **YES** to exit from the Patient Information Setup, all information of patient will be refreshed and the trend data will be renovated.

## CLOCK SETUP

In order to review data easily and intuitively, you should have set a right time. Touch the time area at the top right corner to pop up time setup menu. You can have settings as below:

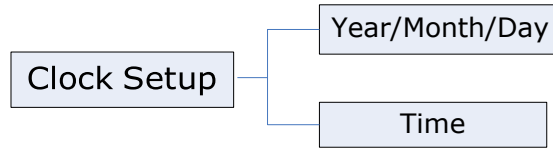

**Figure 19: Tree Diagram for Clock Setup**

The value of year, month, day, hour and minute can be set. System will amend the internal clock according to the new settings.

Once the system time realigned, the trend data will renew correspondingly. On entering the master screen, please checks whether the monitor time and the current time are consistent, if not, please correct them.

## HOW TO RECALL

In Recall menu, choose a user firstly and then choose which parameter is to review.

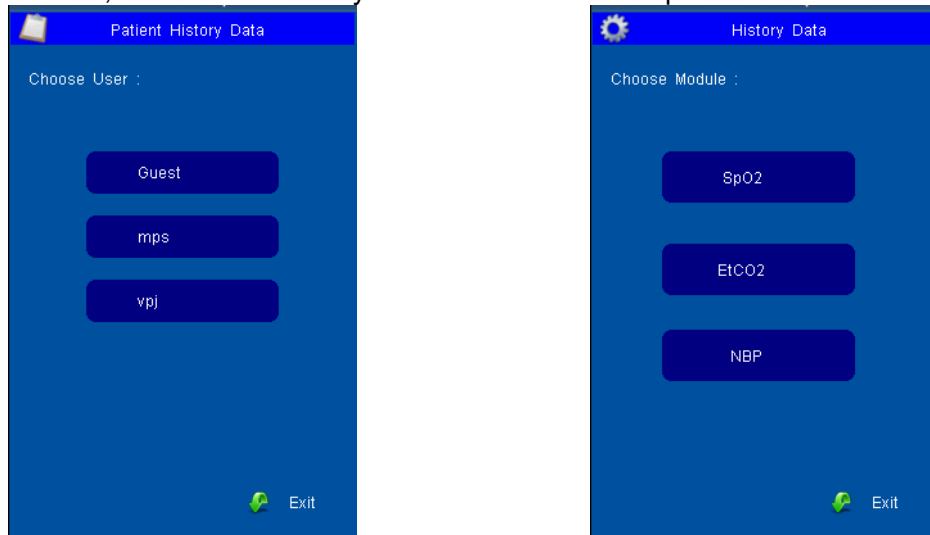

**Figure 20: User Choose and Module Choose**

The parameter value in tabular format could be review if the relevant module is ON. The parameter record will be saved every two seconds.

10 groups of measurement value are listed every page and 300 groups in total. Once the recall memory has stored 300 groups of data, the oldest recall data will be overwritten by new data.

These data will be listed follow the order of from new to former and the time is displaying at the scale-of-24 hours. The parameter name is display on the top of chart and the invalid data will not display. The invalid data will not display.

### SPO2 REVIEW

The SpO<sub>2</sub> History Data review is as below:

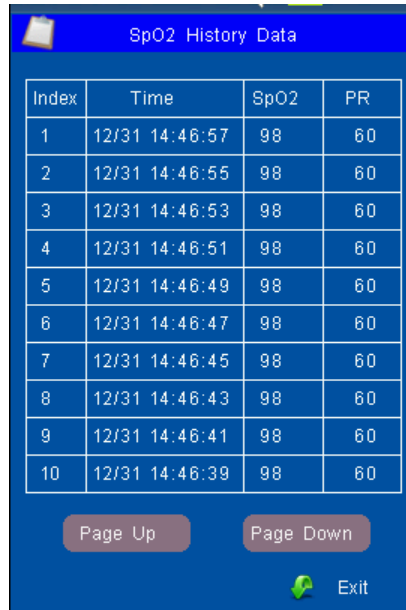

The screenshot shows a screen titled "SpO2 History Data" with a table of 10 rows. Each row contains an index, a time stamp, an SpO2 value, and a PR value. Below the table are two buttons: "Page Up" and "Page Down", and an "Exit" button with a green arrow icon.

Index	Time	SpO2	PR
1	12/31 14:46:57	98	60
2	12/31 14:46:55	98	60
3	12/31 14:46:53	98	60
4	12/31 14:46:51	98	60
5	12/31 14:46:49	98	60
6	12/31 14:46:47	98	60
7	12/31 14:46:45	98	60
8	12/31 14:46:43	98	60
9	12/31 14:46:41	98	60
10	12/31 14:46:39	98	60

**Figure 21: Tabular Trend for SpO<sub>2</sub>**

### ETCO2 REVIEW

The EtCO<sub>2</sub> History Data review is as below:

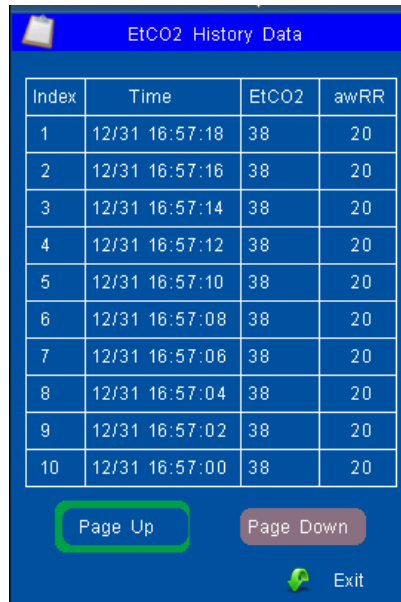

The screenshot shows a screen titled "EtCO2 History Data" with a table of 10 rows. Each row contains an index, a time stamp, an EtCO2 value, and an awRR value. Below the table are two buttons: "Page Up" and "Page Down", and an "Exit" button with a green arrow icon. The "Page Up" button is highlighted with a green border.

Index	Time	EtCO2	awRR
1	12/31 16:57:18	38	20
2	12/31 16:57:16	38	20
3	12/31 16:57:14	38	20
4	12/31 16:57:12	38	20
5	12/31 16:57:10	38	20
6	12/31 16:57:08	38	20
7	12/31 16:57:06	38	20
8	12/31 16:57:04	38	20
9	12/31 16:57:02	38	20
10	12/31 16:57:00	38	20

**Figure 22: Tabular Trend for EtCO<sub>2</sub>**

## NBP REVIEW

The NBP History Data review is as below:

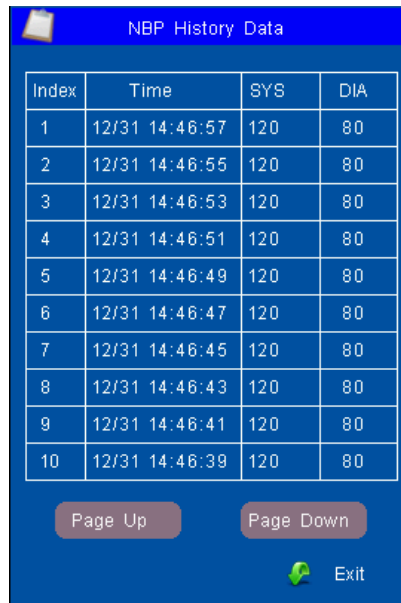

The screenshot shows a screen titled "NBP History Data" with a table of 10 rows. Each row contains an index number, a timestamp, and two numerical values (SYS and DIA). Below the table are two buttons labeled "Page Up" and "Page Down", and an "Exit" button with a green arrow icon.

Index	Time	SYS	DIA
1	12/31 14:46:57	120	80
2	12/31 14:46:55	120	80
3	12/31 14:46:53	120	80
4	12/31 14:46:51	120	80
5	12/31 14:46:49	120	80
6	12/31 14:46:47	120	80
7	12/31 14:46:45	120	80
8	12/31 14:46:43	120	80
9	12/31 14:46:41	120	80
10	12/31 14:46:39	120	80

**Figure 23: Tabular Trend for NBP**

## BATTERY OPERATION

CLEO Patient Monitor is designed to operate on one rechargeable Lithium ion battery whenever AC power supply is interrupted. A symbol is displayed in the upper right quarter of the screen to indicate the status of recharging, in which the color part represents the electric energy of the battery.

A new, fully charged battery will provide about 3 hour of monitoring time under the following conditions: no audible alarms, no analog or serial output devices attached, and no backlight. The charge and discharge cycles life of the battery is about 300 times.

When operating on battery, the monitor will shut off automatically when the electric energy is low. When the electric energy is lower than 25% of total power capacity, the battery signal will change red. Connect the monitor to AC power at this moment can recharge the battery while operating. If keep operating on the battery, the monitor will shut off automatically upon exhaustion of the battery.

**[NOTE]:** Whenever the monitor is connected to AC power, the battery is being charged. Therefore, it is recommended that the monitor remain connected to AC power when not in use. This will make available a fully charged battery for use at any time.

**[NOTE]:** As the battery is used and recharged over a period of time, the amount of time between the onset of the low battery alarm and the instrument shut-off may become shorter.  
If the backlight is turned off during a low battery condition, it cannot be turned back on. It is recommended that the internal battery is replaced by qualified service personnel every 24 months.

**[CAUTION]:** If the CLEO is to be stored for a period of 2 months or longer, notify service personnel to remove the battery from the monitor prior to storage. Recharge the battery when it has not been charged for 2 or more months.

## BATTERY RECYCLE

When a battery has visual signs of damage, or no longer holds a charge, it should be replaced. Remove the old battery from the Patient Monitor and recycle it properly. To dispose of a battery, follow local laws for proper disposal.

**[WARNING]:** DO NOT disassemble batteries, or put them into fire, or cause them to short circuit. They may ignite, explode, or leak, causing personal injury.

## **DISPOSAL OF DEVICE COMPONENTS**

Follow local governing ordinances and recycling instructions regarding disposal or recycling of device components, including batteries.

## CLEANING

To clean the CLEO, dampen a cloth with a commercial, nonabrasive cleaner and wipe the exterior surfaces lightly. Do not allow any liquids to come in contact with the power connector or switches. Do not allow any liquids to penetrate connectors or openings in the instrument. For cables, sensors, and cuffs, follow the cleaning instructions in the directions for use that accompany these accessories.

## PERIODIC SAFETY CHECKS

It is recommended that the following checks be performed every 24 months.

- Inspect the equipment for mechanical and functional damage.
- Inspect the safety relevant labels for legibility.

**[WARNING]:** Do not spray, pour, or spill liquid on CLEO, its accessories, connectors, switches, or openings in the chassis. Do not immerse the CLEO or its accessories in liquid or clean with caustic or abrasive cleaners.

## SPECIFICATIONS

<b>SAFETY</b>	
Meet the requirement of EN60601 series, CE marking according to MDD93/42/EEC	
Equipment not suitable for use in the presence of a flammable anesthetic mixture with air or with oxygen or nitrous oxide	
Type of Protection:	Class I (on AC power) Internally Powered (on battery power)
Degree of Protection:	Type BF - Applied part
Sterilization or Disinfection methods:	70% isopropyl alcohol solution or a nonstaining disinfectant.
Operation Mode:	Continuous Operation
Protection Against Ingress of Liquid's:	IPX0
<b>APPLICATION</b>	
Adults	
Physical Dimensions & Weight	
Base Unit:	120×125×195 mm
Weight:	900 g
<b>PERFORMANCE SPECIFICATIONS</b>	
Display:	5.0 Inch(Diagonal)Color TFT
Resolution:	480×RGB×270
Trace:	2 Waveforms
Waveforms	PLETH, EtCO <sub>2</sub>
Indicator:	Alarm Indicator Power Indicator
Trend time:	10 mins
<b>Nellcor SPO2</b>	
Standard:	ISO 9919
ASpO <sub>2</sub> :	Anti-motion SpO <sub>2</sub>
Measuring Technology:	Light absorption method
SpO <sub>2</sub> Measurement Range:	0~100 %
SpO <sub>2</sub> Accuracy:	70~100 %: ±2 % 0~69 % : Undefined
PR Measurement Range:	30~250 bpm
PR Accuracy:	±2 bpm(non-motion) ±3 bpm (motion)
SpO <sub>2</sub> Alarm Limit:	Upper Limit : 50~99 %, Lower Limit : 50~99 %
SpO <sub>2</sub> Probe:	Red Light LED Wavelength: 660±5 nm Infrared Light LED Wavelength: 940±10 nm
Refreshing Rate:	1 s
Option Type:	Nellcor (See the modules' relative technical specifications)
Operating and Storage Temperature	Operating Temperature 32°F – 113°F Storage Temperature -31°F – 158°F
<b>NIBP</b>	
Standard:	EN 60601-2-30/IEC 60601-2-30, EN 1060-1, EN 1060-3, EN 1060-4, SP10
Measuring Technology:	Automatic Oscillating Measurement
Cuff Inflating:	<30 s (0~300 mmHg, Standard Adult Cuff)
Measuring Period:	AVE<40 s
Mode:	Manual, Auto, STAT

Measuring Interval in AUTO Mode:	1min~4h
Resolution:	1mmHg
Overpressure Protection:	Adult Mode 280 (mmHg)
Alarm Limit:	SYS 30~240 mmHg DIA 15~180 mmHg
<b>CO2</b>	
Mode of Sampling:	Sidestream
Measurement technology:	Infrared Absorption
Principle of Operation:	Non-dispersive infrared (NDIR) Proprietary High Efficiency IR Source, no moving parts Frequency Stable Thermopile
Initialization Time:	Capnogram, displayed in less than 4 seconds, at an ambient temperature of 25°C, Warmup less than 10 seconds
CO <sub>2</sub> Measurement Range:	0 to 150 mmHg, 0 to 19.7%, 0 to 20 kPa
CO <sub>2</sub> Calculation Method:	BTPS (Body Temperature Pressure Saturated)
Response Time:	Rise Time 300 ms Total System Response Time (secs) 4
CO <sub>2</sub> Resolution:	0~69 mmHg: 0.1 mmHg 70~150 mmHg: 0.25 mmHg
CO <sub>2</sub> Accuracy:	0 – 40 mmHg ±2 mmHg (<5%) 41 – 76 mmHg ±5% of reading (5-10%) 76 – 150 mmHg ±8% of reading (10-20%) Above 80 BPM ±10% of reading
CO <sub>2</sub> Stability:	Short term drift: Drift over four hours shall not exceed 2 mmHg maximum Long term drift: Accuracy specification will be maintained over one year
CO <sub>2</sub> Noise:	RMS noise of the sensor is less than or equal to 0.25 mmHg at 5% CO <sub>2</sub>
Sampling Rate:	100 ml/min +-15% of set value
Compensations	Barometric pressure
Calibration	Zero calibration based on time and temperature or as well as on-demand No routine user CO <sub>2</sub> calibration required.
Temperature and Humidity	Operating: 5° to 50°C, 10 to 90% RH, non-condensing Storage: -40° to 70°C, <90% RH, non-condensing
Water Resistance (sensor)	IPX4 – Splash-proof (When gas dryer line is connected to input)
Output Data	Waveform, and parameters respiratory rate, inspiratory CO <sub>2</sub> , PetCO <sub>2</sub> , Ti, Te Balance gas compensation.
Patient Population	Adult
Power requirements	480mW (typical with pump on) 1600mW (extreme status)
<b>NETWORKING</b>	
Wired Networking:	Industry Standard: IEEE 802.3 wired network



## EMC

The product is in radio-interference protection class A in accordance with EN55011. The product complies with the requirement of standard EN60601-1-2:2007 "Electromagnetic Compatibility - Medical Electrical Equipment".

### ELECTROMAGNETIC IMMUNITY

This section constitutes the guidance and CLEO Patient Monitor's declaration regarding electromagnetic immunity. The CLEO Patient Monitor is intended for use in the electromagnetic environment specified below. The customer or the user of the CLEO Patient Monitor should assure that it is used in such an environment.

Immunity test	IEC 60601 test level	Compliance level	Electromagnetic environment – guidance
Electrostatic discharge (ESD) IEC 61000-4-2	<input type="checkbox"/> 6 kV contact <input type="checkbox"/> 8 kV air	<input type="checkbox"/> 6 kV contact <input type="checkbox"/> 8 kV air	Floors should be wood, concrete or ceramic tile. If floors are covered with synthetic material, the relative humidity should be at least 30%.
Electrical fast transient/burst IEC 61000-4-4	2 kV for power supply lines 1 kV for input / output lines	2 kV for power supply lines 1 kV for input / output lines	Mains power quality should be that of a typical commercial or hospital environment.
Surge IEC 61000-4-5	<input type="checkbox"/> 1 kV differential Mode <input type="checkbox"/> 2 kV differential Mode	<input type="checkbox"/> 1 kV differential Mode <input type="checkbox"/> 2 kV differential Mode	Mains power quality should be that of a typical commercial or hospital environment.
Voltage dips, short interruptions and voltage variations on power supply input lines IEC 61000-4-11	<5 % UT1 (>95 % dip in UT) for 0.5 cycle 40 % UT (60 % dip in UT) for 5 cycles 70 % UT (30 % dip in UT) for 25 cycles <5 % UT (>95 % dip in UT) for 5 sec	<5 % UT2 (>95 % dip in UT) for 0.5 cycle 40 % UT (60 % dip in UT) for 5 cycles 70 % UT (30 % dip in UT) for 25 cycles <5 % UT (>95 % dip in UT) for 5 sec	Mains power quality should be that of a typical commercial or hospital environment. If the user of the CLEO Patient Monitor requires continued operation during power mains interruptions, it is recommended that the CLEO Patient Monitor be powered from an uninterruptible power supply or a battery.
Power frequency (50/60 Hz) magnetic field IEC 61000-4-8	3 A/m	3 A/m	Power frequency magnetic fields should be at levels characteristic of a typical location in a typical commercial or hospital environment.

Note:  $U_T$  is the a. c. mains voltage prior to application of the test level.

Immunity test	IEC 60601 test level	Compliance level	Electromagnetic environment – guidance
<p>Conducted RF IEC 61000-4-6</p> <p>Radiated RF IEC 61000-4-3</p> <p>Only ISA CO<sub>2</sub> is tested at 20 V/m</p>	<p>3 Vrms 150 kHz to 80 MHz</p> <p>3 V/m 80%AM@2Hz 80 MHz to 2.5 GHz</p> <p>20 V/m 80%AM@1kHz z 80 MHz to 2.5 GHz</p>	<p>3 Vrms</p> <p>3 V/m</p> <p>20 V/m</p>	<p>Portable and mobile RF communications equipment should be used no closer to any part of the CLEO Patient Monitor, including cables, than the recommended separation distance calculated from the equation applicable to the frequency of the transmitter.</p> <p>Recommended separation distance:</p> $d = \left[ \frac{3.5}{V_1} \right] \sqrt{P}$ $d = \left[ \frac{3.5}{V_1} \right] \sqrt{P}$ <p>80 MHz to 800 MHz</p> $d = \left[ \frac{7}{E_1} \right] \sqrt{P}$ <p>800 MHz to 2.5 GHz</p> <p>Where P is the maximum output power rating of the transmitter in watts (W) according to the transmitter manufacturer and d is the recommended separation distance in meters (m).</p> <p>Field strengths from fixed RF transmitters, as determined by an electromagnetic site survey, a should be less than the compliance level in each frequency range.b Interference may occur in the vicinity of equipment marked with the following symbol:</p> 

**[NOTE 1]: At 80 MHz and 800 MHz, the higher frequency range applies.**

**[NOTE 2]: These guidelines may not apply in all situations. Electromagnetic propagation is affected by absorption and reflection from structures, objects and people.**

a. Field strengths from fixed transmitters, such as base stations for radio (cellular/cordless) telephones and land mobile radios, amateur radio, AM and FM radio broadcast and TV broadcast cannot be predicted theoretically with accuracy. To assess the electromagnetic environment due to fixed RF transmitters, an electromagnetic site survey should be considered. If the measured field strength in the location in which the CLEO Patient Monitor is used exceeds the applicable RF compliance level above, The CLEO Patient Monitor should be observed to verify normal operation. If abnormal performance is observed, additional measures may be necessary, such as reorienting or relocating the CLEO Patient Monitor.

b. Over the frequency range 150 kHz to 80 MHz, field strengths should be less than 3V/m.

Immunity test	IEC 60601 test level	Compliance level	Electromagnetic environment – guidance
<b>Recommended separation distances between portable and mobile RF communications equipment and the CLEO Patient Monitor</b>			
<p>The CLEO Patient Monitor is intended for use in an electromagnetic environment in which radiated RF disturbances are controlled.</p> <p>The customer or the user of the CLEO Patient Monitor can help prevent electromagnetic interference by maintaining a minimum distance between portable and mobile RF communications equipment (transmitters) and the CLEO Patient Monitor as recommended below, according to the maximum output power of the communications equipment</p>			
<b>Rated maximum output power of transmitter [W]</b>	<b>Separation distance according to frequency of transmitter [m]</b>		
	<b>150 kHz to 80 MHz</b> $d = \left[ \frac{3.5}{V_1} \right] \sqrt{P}$	<b>80 MHz to 800 MHz</b> $d = \left[ \frac{3.5}{V_1} \right] \sqrt{P}$	<b>800 MHz to 2.5 GHz</b> $d = \left[ \frac{7}{E_1} \right] \sqrt{P}$
<b>0.01</b>	<b>0.12</b>	<b>0.12</b>	<b>0.23</b>
<b>0.1</b>	<b>0.38</b>	<b>0.38</b>	<b>0.73</b>
<b>1</b>	<b>1.2</b>	<b>1.2</b>	<b>2.3</b>
<b>10</b>	<b>3.8</b>	<b>3.8</b>	<b>7.3</b>
<b>100</b>	<b>12</b>	<b>12</b>	<b>23</b>
<p>For transmitters rated at a maximum output power not listed above, the recommended separation distance d in meters (m) can be estimated using the equation applicable to the frequency of the transmitter, where P is the maximum output power rating of the transmitter in watts (W) according to the transmitter manufacturer.</p> <p><b>[NOTE 1]:</b> At 80 MHz and 800 MHz, the separation distance for the higher frequency range applies.</p> <p><b>[NOTE 2]:</b> These guidelines may not apply in all situations. Electromagnetic propagation is affected by absorption and reflection from structures, objects and people.</p>			